

Ì ÈÌ ÈÑÒÁÐÑÒÁÌ ÑÀÈÛÑÊÌÁÌ ÕÌ ÇΒÉÑÒÁÀ ÐÌ ÑÑÈÉÑÊÌÉ ÕÁÁÁÐÀÕÈÈ
ÁÁÌÁÐÒÁÌ ÁÌ Ò ÍÁÓ×ÌÌ -ÒÁÕÌÌÊÌÁÈ×ÁÑÊÌÉ ÌÌÈÈÒÈÈÈ È ÍÁÐÀÇÌÁÁÌÈΒ
ÕÁÁÌ Ó ÁÌ ÊÌÑÒÐÌÌÑÈÀΒ ÁÑÕÀ

Êàõääðà ñòðìèòääüíúå êìíñòðóèèè

À.Â.Ì đãõî â

Í À×ÁÐÒÀÒÀÈÛÌ ÀΒ
ÃÁÌ Ì ÁÒÐÈΒ

ðääì ÷ àÿ òåòðääü
äëÿ çài èñè èääèèè

*äëÿ ñòóääí òìâ, íáó÷àðùèõñÿ ìì
íàiðääèáièÿ ììääì òìâèè 35.03.06 Áãðìèíæáiáðèÿ è
23.03.03 Ýèñìéóàòòèÿ òðáiñììðòìì-òãõììèìãè÷ãñèè
ìàøèì è êìììèääèñìâ ì÷ììé è çài÷ììé òìðì ìáó÷áièÿ*

Âùììèíèè ñòóääí ò

òääóèüòåòà

Í àìðääèáièå

Êìñòðìì à 20__ / 20__

ÓÄË 744.
ÁÁË 30.11ÿ7
Í 36

*Ñîñòàâèòâëü: é.ò.í., äîöáíò èàôáäðú ñòðîèòâëüíúâ
êîíñòðóèèè Á.Á. Íðáõîá.*

*Ðáöáíçáíò: é.ò.í., äîöáíò èàôáäðú ðáìííò è ìñîíâú
êîíñòðóèèèâáíèÿ ìàøèí Ñ.Á. Æóèîá.*

*Ðáèíì áíáíâáíî ìáòîäè-âñéíé êîíèññèáé àððèòâèòóðîí-ñòðîèòâëüíâí
òâèóëüòâòà, á èà-âñòââ ðááí-âé òáòðáâè, ó-âáíáí ìíñíáèÿ, èìáðùâáí
íñíáúé àèääèòè-âñèèé àííàðàò, ñííñíáñòâóðùèé ñàìíñòíÿòâëüíé
ðááíòâ íáó-âðùèòñÿ ìí íáó-âðùèòñÿ ìí íáìðáâèáíèÿ ìíâáíòíâèè 35.03.06
Áäðíèíáíáðèÿ è 23.03.03 Ýñíèóáòâòèÿ òðáíñíðòîí-òáðîíèíâè-âñèèò
ìàøèí è êîííèèâèñíâ í-ííé è çáí-ííé òíðì íáó-áíèÿ íà êîíòâèòóíó
çáíÿðèÿ ìí àèñòèèèèá íà-âðòâòâëüíâÿ ááíìáððèÿ.*

Í 36 Íà-âðòâòâëüíâÿ ááíìáððèÿ. ðááí-âÿ òáòðáâü äèÿ
çáíèèè èâèèè /ñîñò. Á.Á. Íðáõîá. - *Êîíòðîíà.-ÊÄÑÒÀ,*
2020.-152 ñ.; èè.; 30 ñí.-100 ÿç.-Òâèñò: íáìíñðáñòâáííúé.

*Ñíááðæèò áðàòè-âñèèé ìàòâðèè, òðááóðùèèñÿ ìðè èçèíáíèè èóðñà
èâèèè. Ííÿñíáíèÿ è ðááíòâì ñèááóáò áúííèíÿòó ìà ìñòââèáííó
ñáíáíáíúè ìáñòâò á òáòðáâè èèè íà ÷èñòóò èèñòâò áóìáâè, áñòââèá èò
ìáæáò ñòðáíèòâè è. Òáòðáâü ìíèííòðùð ñííòâáòñòâóðùèé ÿèèòðîíííó
èóðñò èâèèè äèÿ íáó-âðùèòñÿ íáó-âðùèòñÿ ìí íáìðáâèáíèÿ ìíâáíòíâèè
35.03.06 Áäðíèíáíáðèÿ è 23.03.03 Ýñíèóáòâòèÿ òðáíñíðòîí-
òáðîíèíâè-âñèèò ìàøèí è êîííèèèâèñíâ í-ííé è çáí-ííé òíðì íáó-áíèÿ
íà êîíòâèòóíó çáíÿðèÿ ìí àèñòèèèèá íà-âðòâòâëüíâÿ ááíìáððèÿ.*

ÓÄË 744.
ÁÁË 30.11ÿ7

Íñí. è áàòâ
Êñ 1 áàòâ
Äçáí. èñ 1
Íñí. è áàòâ
Êñ 1 ññè

Í à÷ᾰḏḡḗḗḗḗḗḗ ᾰḃ ᾰḗḗ ἰ ᾰḡḗḗḗ -

Ḑᾰḗᾰῇḡῇᾰ ἰ ᾰ÷ᾰḏḡḗḗḗḗḗḗ ἰ ῃ ᾰḗḗ ἰ ᾰḡḗḗḗ



Ḃᾰῇῇῇᾰ



ἰ ῃᾰḡḗ ἰ



ἂḗḗḗ ᾰḡ ἰ ἰ ἰ ᾰῃ

Ἐἰᾰ ḗ ἰ ἰ ᾰῃ.	ἰ ἰ ᾰḗ. ῃ ᾰḡḗḗ	ἂḗᾰἰ. ῃ ῃ ᾰ.	Ἐἰᾰ ḗ ᾰḡᾰῃ.	ἰ ἰ ᾰḗ. ῃ ᾰḡᾰῃ.
---------------	----------------	--------------	-------------	-----------------

Ἐḗḗ.	Ἐῇḗḡ	ḗ ᾰḗῇḡḗ.	ἰ ἰ ᾰḗ.	ἂᾰḡᾰ
------	------	----------	---------	------

Ἰῆῖῥᾱᾰίῃᾱ ὀἶ÷ῃῇ ᾶ ἰῖῖῥῖῇᾰἰῇᾰᾱ

Ἐπισημὸν τῆς ἁγιῶτης Ἐκκλησίας τῆς ἁρχαίας Ἀρχαίας



Ἐπισημὸν ἁγιῶτατον



Ἐπισημὸν ἁγιῶτατον Ἐπισημὸν ἁγιῶτατον



Ἐπισημὸν ἁγιῶτατον Ἐπισημὸν ἁγιῶτατον

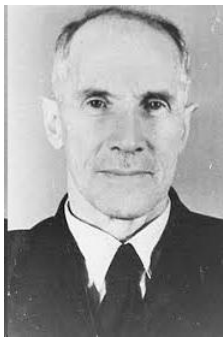

Ἐπισημὸν ἁγιῶτατον Ἐπισημὸν ἁγιῶτατον

Ἐπισημὸν ἁγιῶτατον
Ἐπισημὸν ἁγιῶτατον
Ἐπισημὸν ἁγιῶτατον
Ἐπισημὸν ἁγιῶτατον
Ἐπισημὸν ἁγιῶτατον

Ἐπισημὸν ἁγιῶτατον	Ἐπισημὸν ἁγιῶτατον	Ἐπισημὸν ἁγιῶτατον	Ἐπισημὸν ἁγιῶτατον
Ἐπισημὸν ἁγιῶτατον	Ἐπισημὸν ἁγιῶτατον	Ἐπισημὸν ἁγιῶτατον	Ἐπισημὸν ἁγιῶτατον

Ἰἱεἱραἱ εἰς τὸν ἁγιῶτατον Πατριάρχην

Νούιήνου ιδιὰοὐδιδιὰαίεϋ

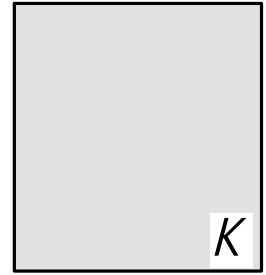

Οαίὸδαεϋίή -

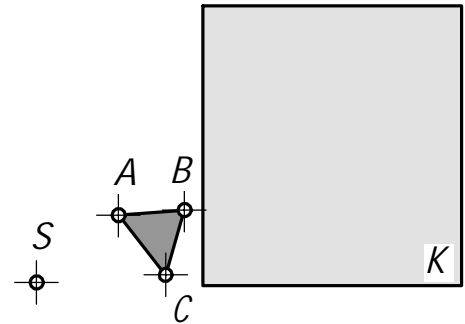

Ιδϋιήοαίεϋίή
εήνηοαίεϋίή

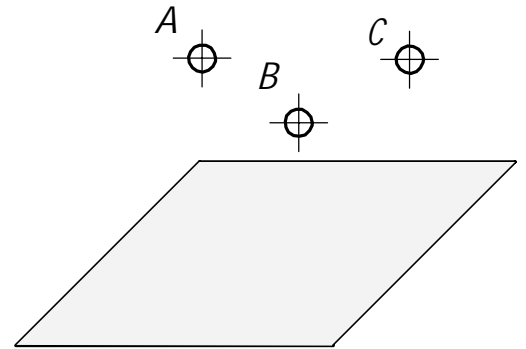

Ιδϋιήοαίεϋίή
(ιδὸιήίηαεϋίή)

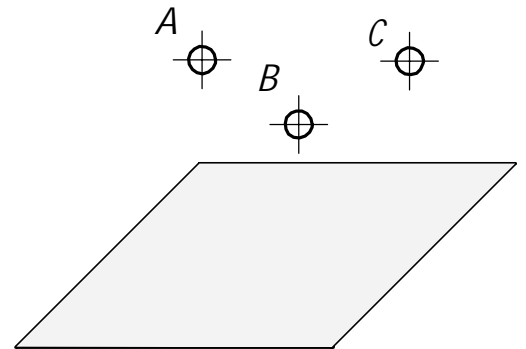

Εία 1 ιδιὰ	Ιήι. ε αὐα
Ααί. εία 1	Εία 1 αὐα
Ιήι. ε αὐα	
Εία 1 ιδιὰ	

Εϋι.	Εεὸ	1 αήεοι.	Ιήι.	Ααὐα
------	-----	----------	------	------

Ιήεήαίεα οί:εε α ιδιήνουδιδιήα

Āēäü ïðĩñòðāĩñòââíēý

[Empty box]

[Empty box]

[Empty box]

[Empty box]

ĩðĩñòðāĩñòââíēāý ïîääëü òī÷ēē

Ñāî ēñòââ ÷âðòâæà -

Î áðàòèì îñòü-

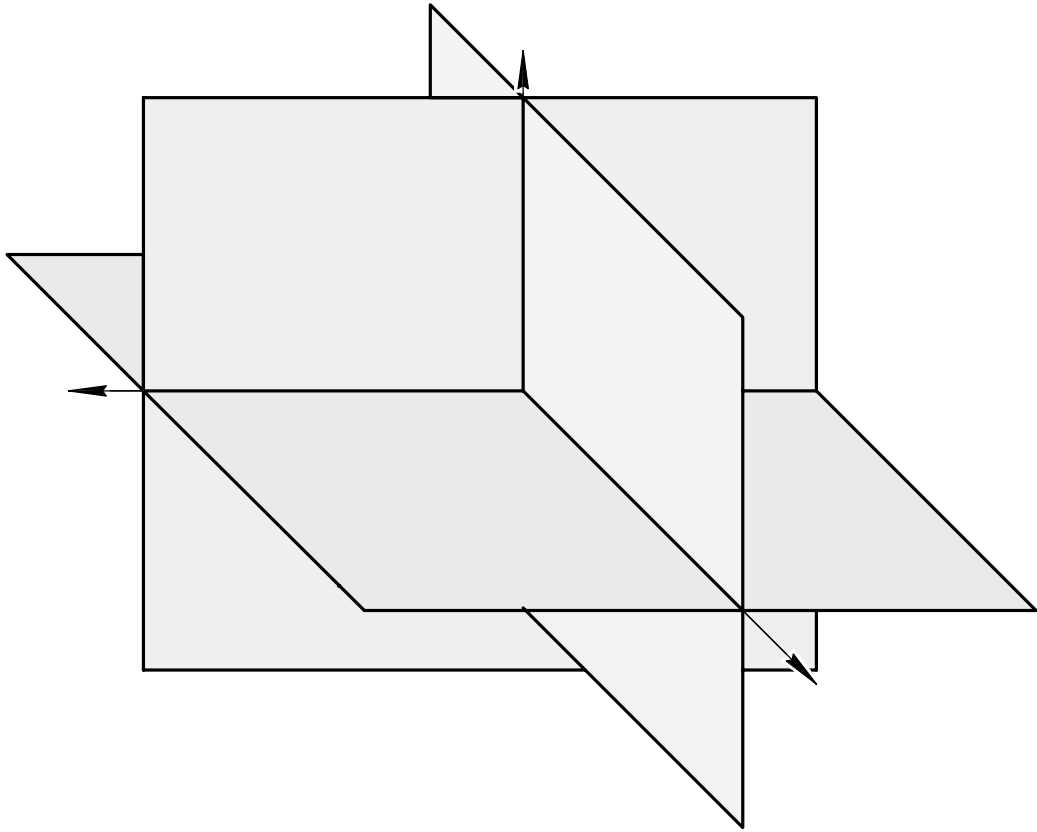

Īīāī. è āāōā
Ēīā. 1 āāæ
Āçāī. ēīā. 1
Īīāī. è āāōā
Ēīā. 1 Īīāē

Î âĩçíà÷áíëÿ ìĕîñĕîñòâé ïðîáēöèé

Ṽ- ôðîíòàèüíàÿ ìĕîñĕîñòü ïðîáēöèé

Ěῇῇῇ ìăðăñă÷áíëÿ ìĕîñĕîñòâé ïðîáēöèé

Ĕîîðăëíàòû òî:èè

Î êòàíò -

Éía ṽ ĩṽâé.	Îîîî. è âàòâ	Āçâî. èíá. ṽ	Éíá. ṽ ãóâé.	Îîîî. è âàòâ
Éçî.	Ěēñò	ṽ âĕōî.	Îîîî.	Āàòâ

Î êòàíò / Î ñü	X	Y	Z
I	+	+	+
II			
III			
IV			
V			
VI			
VII			
VIII			

Ἰἱἱἱἱἱἱἱἱἱ ὀἱἱἱἱἱἱ ἱἱἱἱἱἱ ἱἱἱἱἱἱἱἱἱἱ ἱἱἱἱἱἱἱἱἱἱ

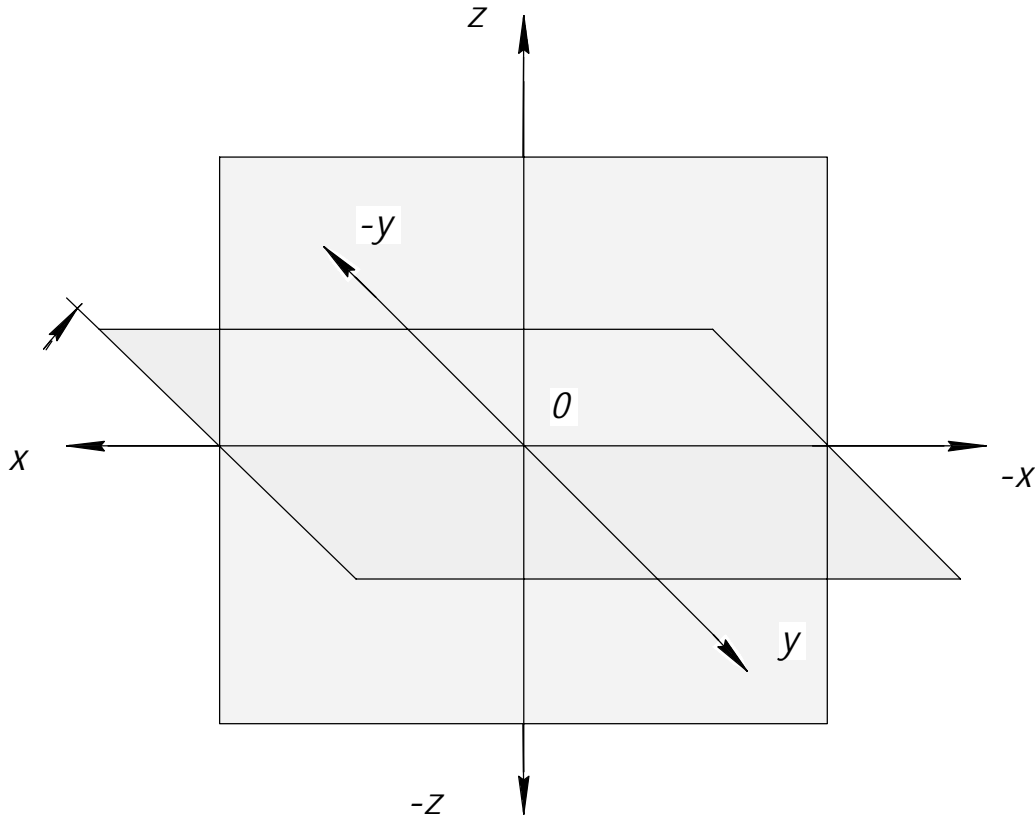

x _____

Ἰἱἱἱἱἱἱ ἁ ἱἱἱἱἱἱ
Ἰἱἱἱἱἱἱ ἱἱἱἱἱἱἱ
Ἰἱἱἱἱἱἱἱἱἱ ἱἱἱἱἱἱἱ
Ἰἱἱἱἱἱἱἱἱἱ ἁ ἱἱἱἱἱἱ
Ἰἱἱἱἱἱἱἱἱἱ ἱἱἱἱἱἱἱ

Ἰἱἱἱἱἱἱἱἱἱ	Ἰἱἱἱἱἱἱἱἱἱ	Ἰἱἱἱἱἱἱἱἱἱ	Ἰἱἱἱἱἱἱἱἱἱ
Ἰἱἱἱἱἱἱἱἱἱ	Ἰἱἱἱἱἱἱἱἱἱ	Ἰἱἱἱἱἱἱἱἱἱ	Ἰἱἱἱἱἱἱἱἱἱ

Ἰἱἱἱἱἱἱἱἱἱ ὀἱἱἱἱἱἱ ἁ ἱἱἱἱἱἱἱἱἱἱἱἱἱἱἱἱ

Επιχειρησιακό Πρόγραμμα

Επιχειρησιακό -

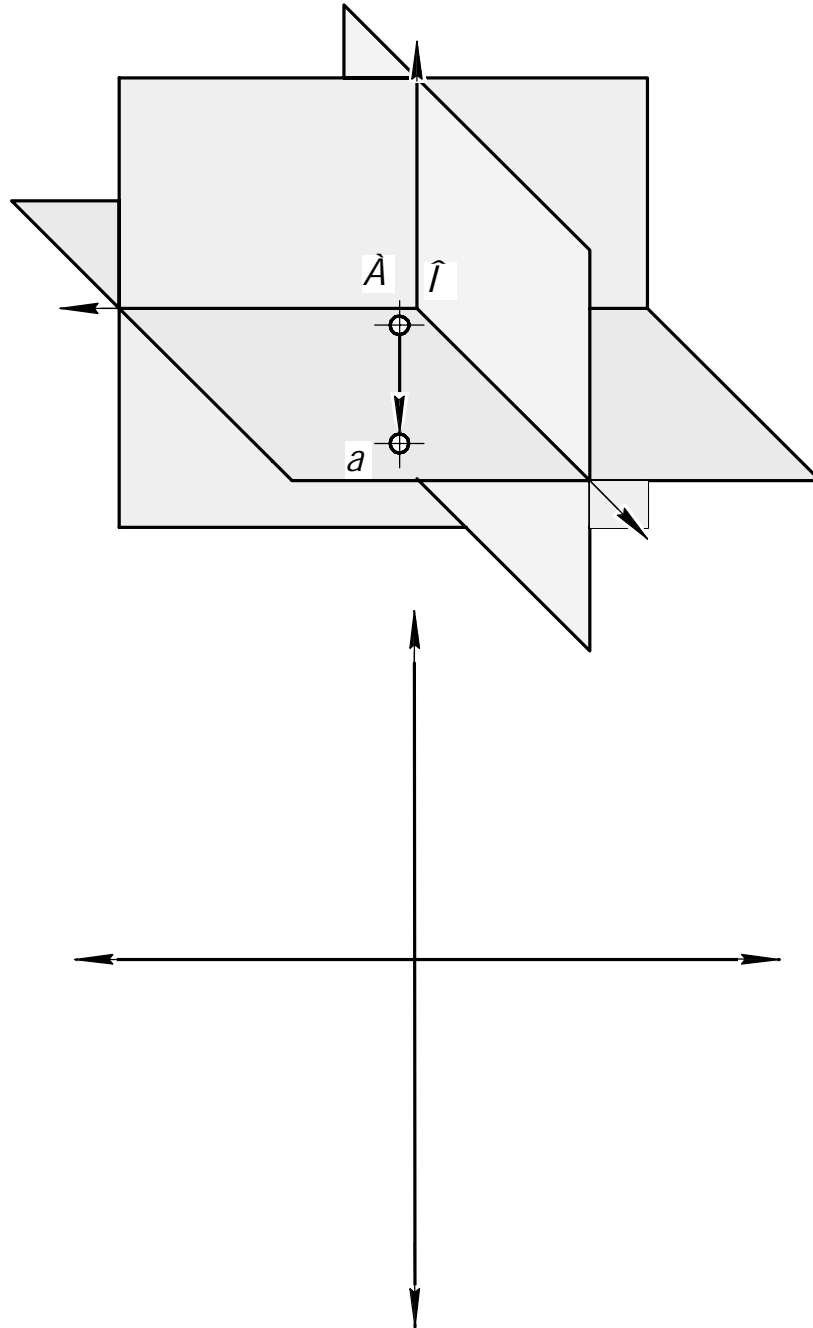

Ναί εὐθὺς ἔχει

- 1.
- 2.

Εἶδος ἰσχύος	Ἰσχύος ἔσοδος	Ἰσχύος ἔσοδος	Ἰσχύος ἔσοδος
Εἶδος ἰσχύος	Ἰσχύος ἔσοδος	Ἰσχύος ἔσοδος	Ἰσχύος ἔσοδος

Ἰῖῥᾶίῃᾱ ὀῖᾱῖῃῃ ἰῑῖῥᾶίῃᾱ ὀῖ÷ῆῇ ἰῖ ᾱᾱῖ ῥᾶᾱίῖῖ

Ἰῑῖῥᾶίῃῖῖῖ

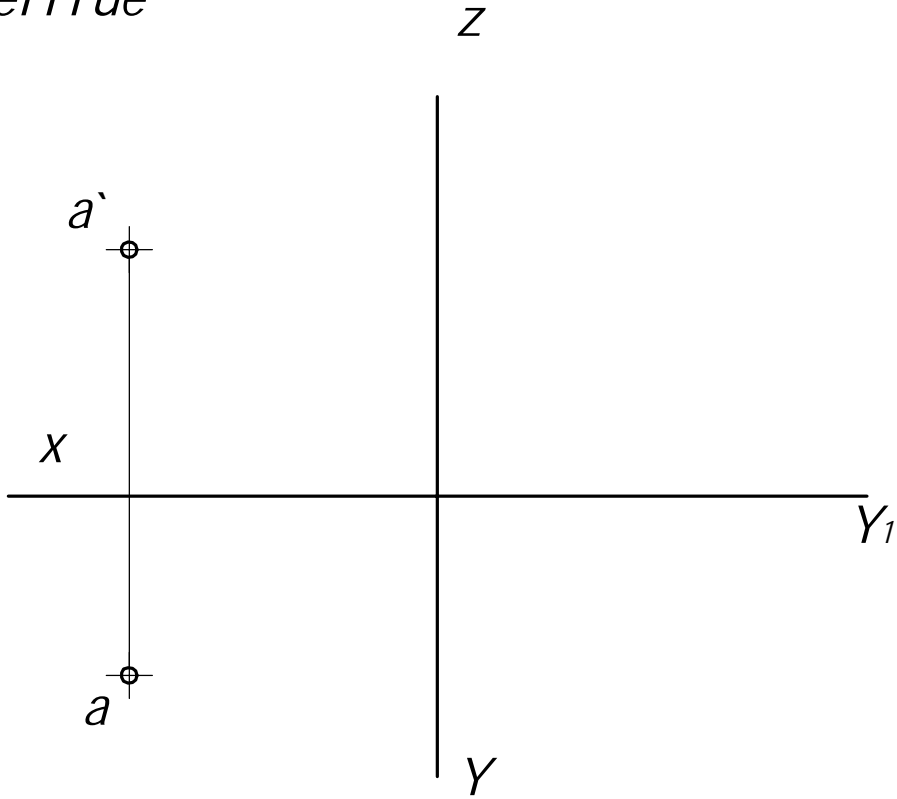

Ἐῖῖῑᾱῖῖᾱῖῖ

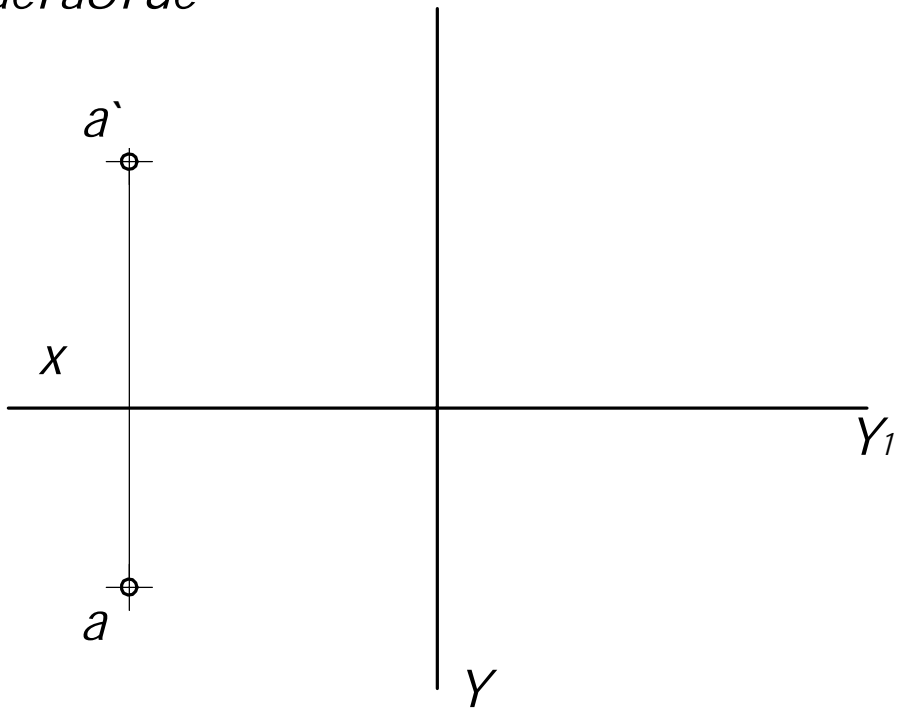

Ἰῖῖῖῖ ῃ ᾱᾱᾱ
Ἐῖᾱ 1 ᾱᾱᾱ
Ἀῥᾱῖ ῃᾱ 1
Ἰῖῖῖῖ ῃ ᾱᾱᾱ
Ἐῖᾱ 1 ῖῖᾱῖ

Ἐῥῖ.	Ἐῆῖᾱ	1 ᾱῖῃῖῖ.	Ἰῖῖῖῖ.	Ἀᾱᾱᾱ
------	------	----------	--------	------

Ἰῖῖῖῥᾶίῃᾱ ὀῖῖῖῇ ᾱ ἰῑῖῥᾶίῃᾱῖῖῖῖ

Ἐῆῖᾱ
10

Νόμος του Σιμωά: $\vec{r} = x\hat{i} + y\hat{j} + z\hat{k}$

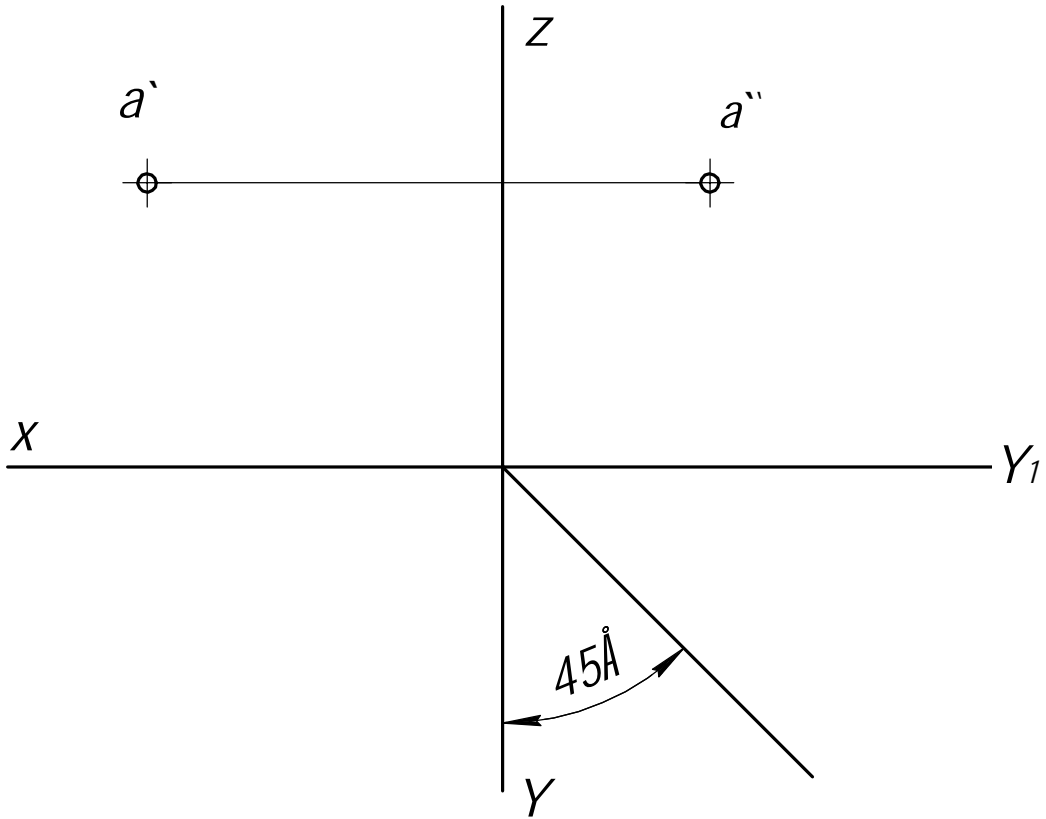

Απόδειξη του νόμου του Σιμωά (5,10,15)

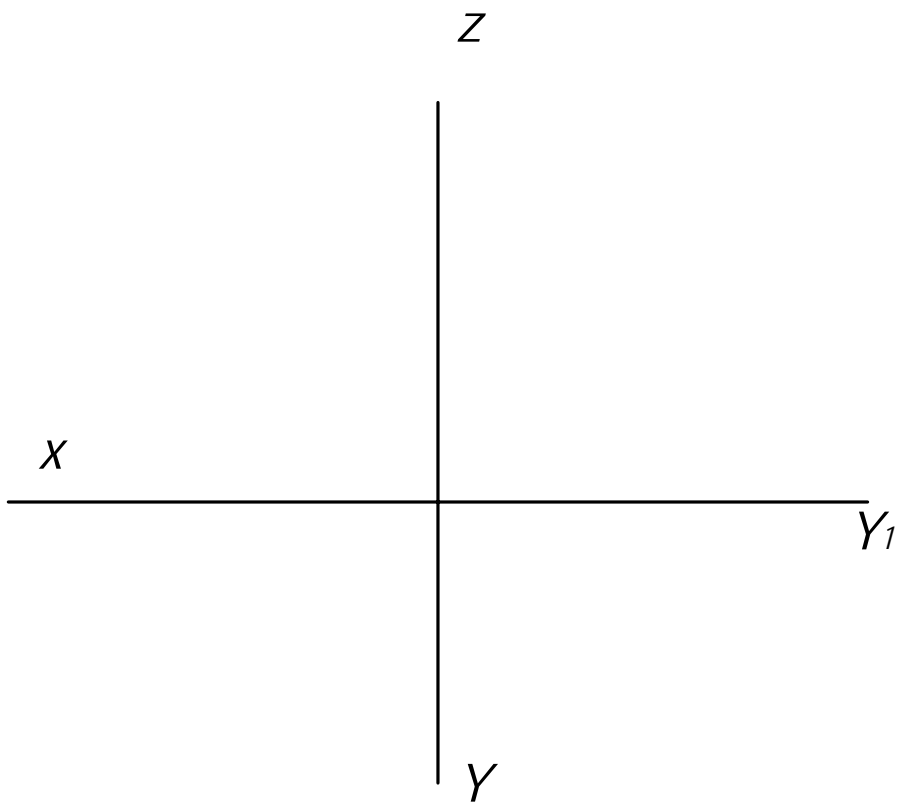

Εύρεση	Απόδειξη	Απόδειξη	Απόδειξη	Απόδειξη
Εύρεση	Απόδειξη	Απόδειξη	Απόδειξη	Απόδειξη

ι ι ο ι ε ε ο ε ι ο ι

Ἰδῖ ἀέοεὲ ἰδῖι ἱέ. Ἐἔανῆεὐεἔαὐὲῖ ἰδῖι ὑὸ
ἰδῖι ἄῖ ἄ ἰδῖ ἡὸδᾶίῆὸᾶᾶ

Ἐἔανῆεὐεἔαὐὲῖ ἰδῖι ὑὸ

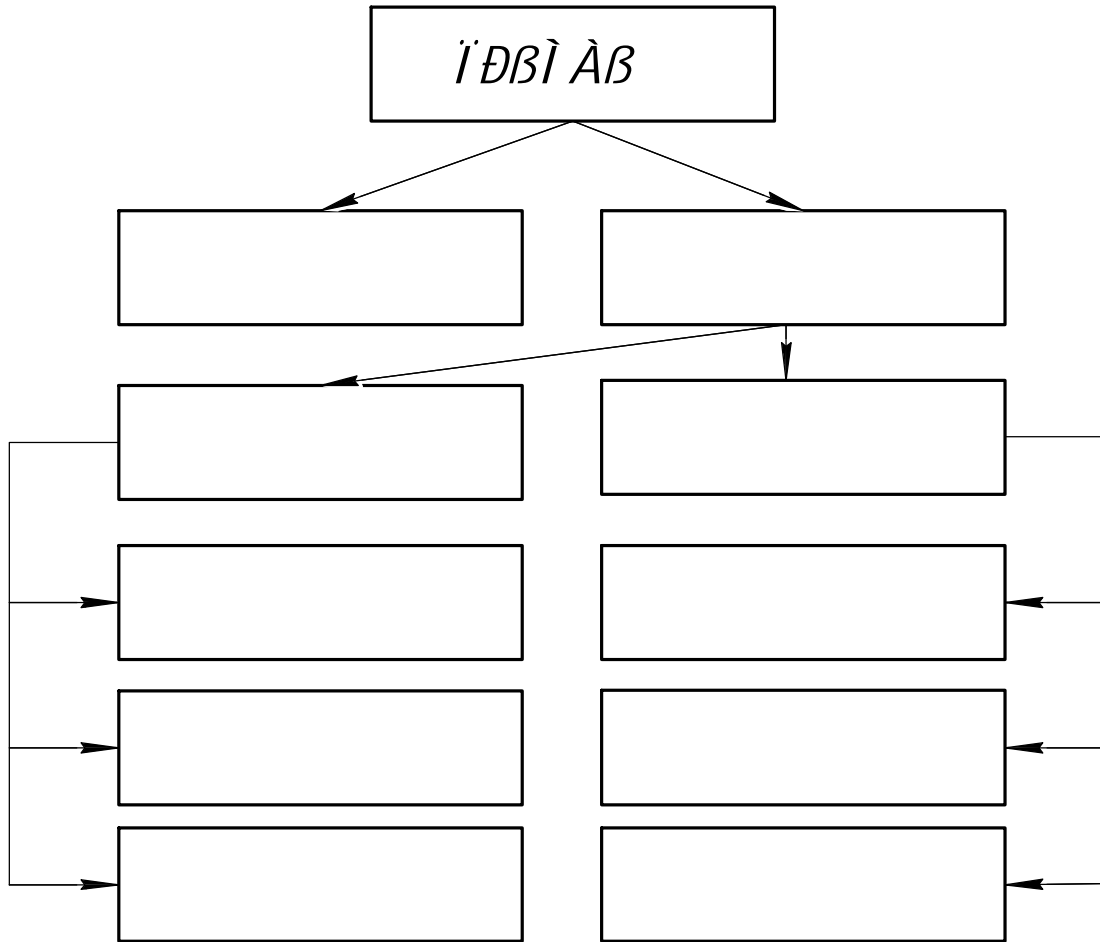

Ἰδῖ ἀέοεὲ ἰδῖι ἱέ

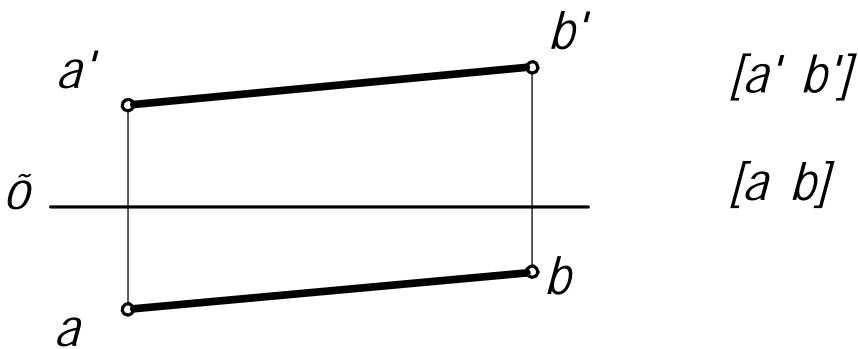

Ἰῖἰ. ἔ ἄαὐ
Ἐἱ ᾶ ᾶαἔ
Ἀῖἰ. εἱᾶ ᾶ
Ἰῖἰ. ἔ ἄαὐ
Ἐἱ ᾶ ᾶαἔ

Ἐῖ.	Ἐἔῆ	ᾶ ἄἔῖ.	Ἰῖἰ.	Ἀᾶᾶ
-----	-----	--------	------	-----

Ἰδῖ ἀέοεὲ ἰδῖι ἱέ

Ἐἔῆ
1

ἰδῶν ἰδῶν ἰδῶν ἰδῶν

ἰδῶν ἰδῶν ἰδῶν ἰδῶν

ἰδῶν ἰδῶν ἰδῶν ἰδῶν -

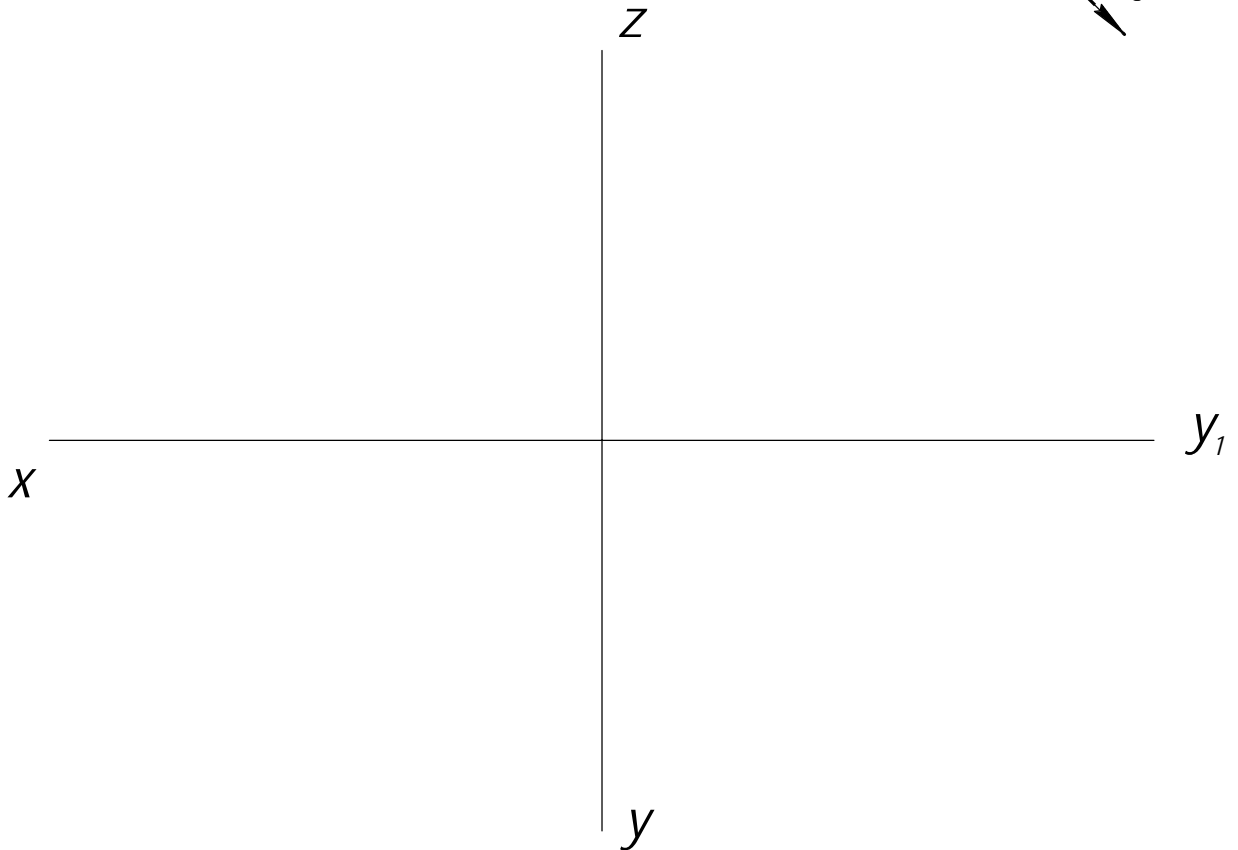
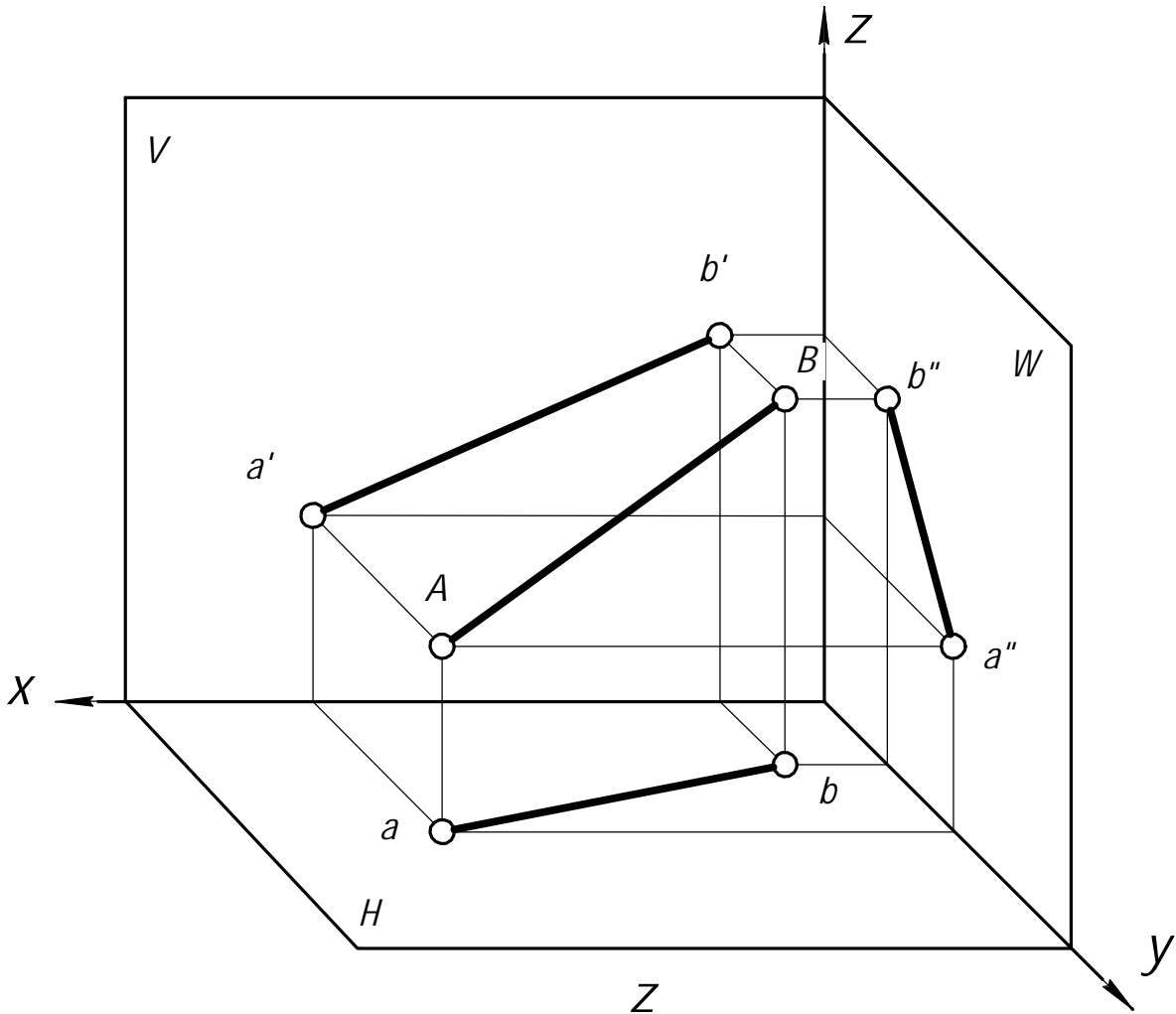

ἰδῶν ἰδῶν	ἰδῶν ἰδῶν	ἰδῶν ἰδῶν	ἰδῶν ἰδῶν
ἰδῶν ἰδῶν	ἰδῶν ἰδῶν	ἰδῶν ἰδῶν	ἰδῶν ἰδῶν
ἰδῶν ἰδῶν	ἰδῶν ἰδῶν	ἰδῶν ἰδῶν	ἰδῶν ἰδῶν
ἰδῶν ἰδῶν	ἰδῶν ἰδῶν	ἰδῶν ἰδῶν	ἰδῶν ἰδῶν

ἰδῶν ἰδῶν	ἰδῶν ἰδῶν	ἰδῶν ἰδῶν	ἰδῶν ἰδῶν
ἰδῶν ἰδῶν	ἰδῶν ἰδῶν	ἰδῶν ἰδῶν	ἰδῶν ἰδῶν

ἰδῶν ἰδῶν ἰδῶν ἰδῶν

ἰδῶν ἰδῶν

Î ðääääéáíèå ìàððàëüîîé ååèè-éíû îððåçèà
ìðÿì îé îáùääî ìîéîæáíèÿ

Îðääèè ìðÿì îóáîëüîîî òððóáîëüîèè.

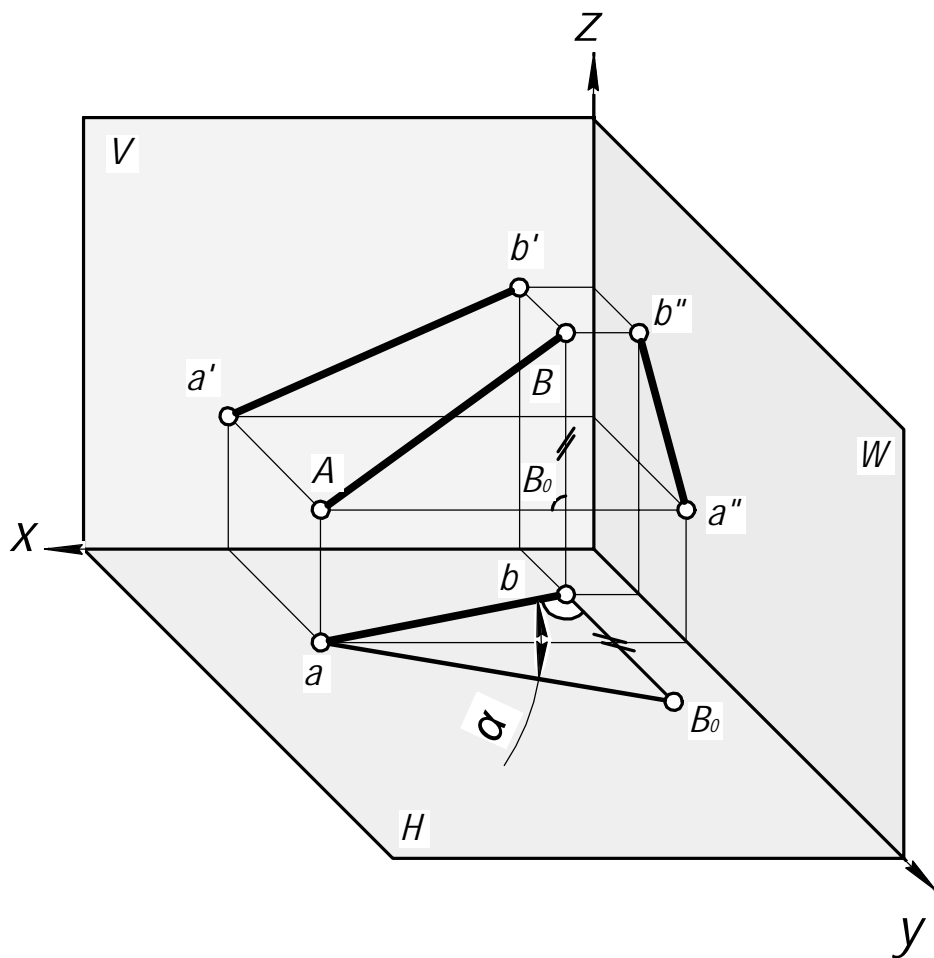

Îñî. è äàðà
Èñà. 1 äàðè
Äçàì. èñà. 1
Îñî. è äàðà
Èñà. 1 ìñàè

Èçì. Èèñò	1 äñèóì.	Îñî. Äàðà
-----------	----------	-----------

Îðîñèèèè ìðÿì îé

Èèñò
3

İ̇đĩãêöèè ĩđÿĩ ĩé

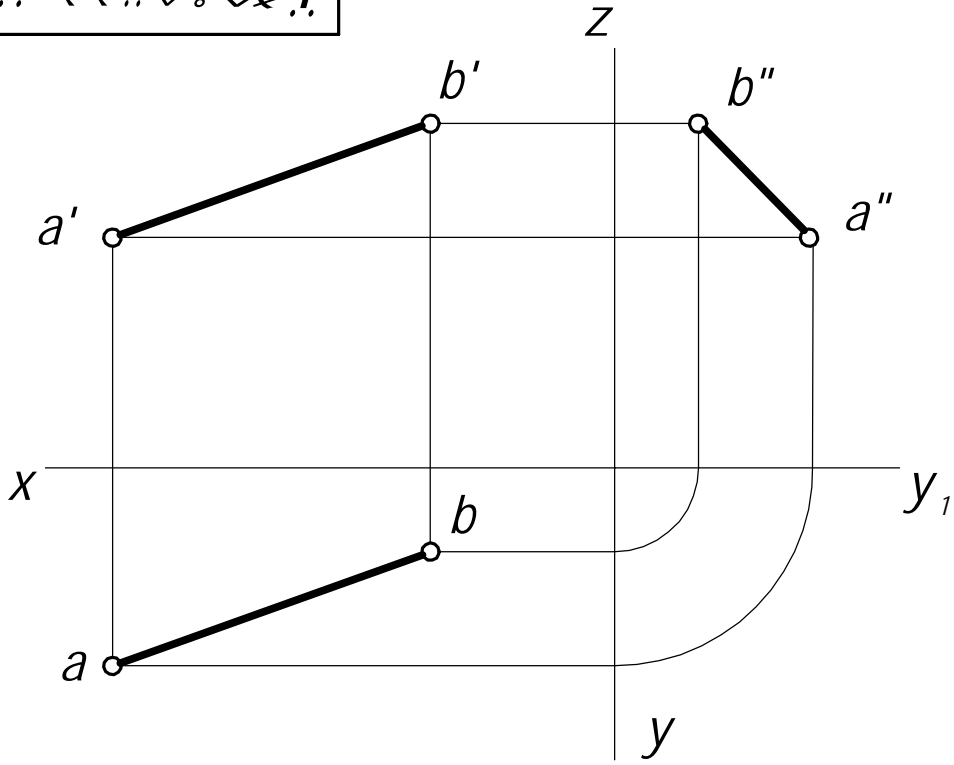

İ̇đÿĩ ûã ÷ãñòĩĩãĩ ĩĩêĩæãĩèÿ

Èèĩèÿ óđĩãĩÿ

Ñãĩêñòãã ãĩðèçĩĩðãëüĩĩé èèĩèè óđĩãĩÿ

<i>Èĩã ĩĩãê.</i>	<i>İ̇ĩãĩ. èãòã</i>
<i>Èĩã ĩĩãê.</i>	<i>Èĩã ĩĩãê.</i>
<i>Èĩã ĩĩãê.</i>	<i>Èĩã ĩĩãê.</i>
<i>Èĩã ĩĩãê.</i>	<i>Èĩã ĩĩãê.</i>

<i>Èçĩ.</i>	<i>Èêñò</i>	<i>ĩãĩêóĩ.</i>	<i>İ̇ĩãĩ.</i>	<i>Ããòã</i>
-------------	-------------	----------------	---------------	-------------

İ̇đĩãêöèè ĩđÿĩ ĩé

Ãîðçîíðàèüíàÿ èèíèÿ óðîáíÿ-

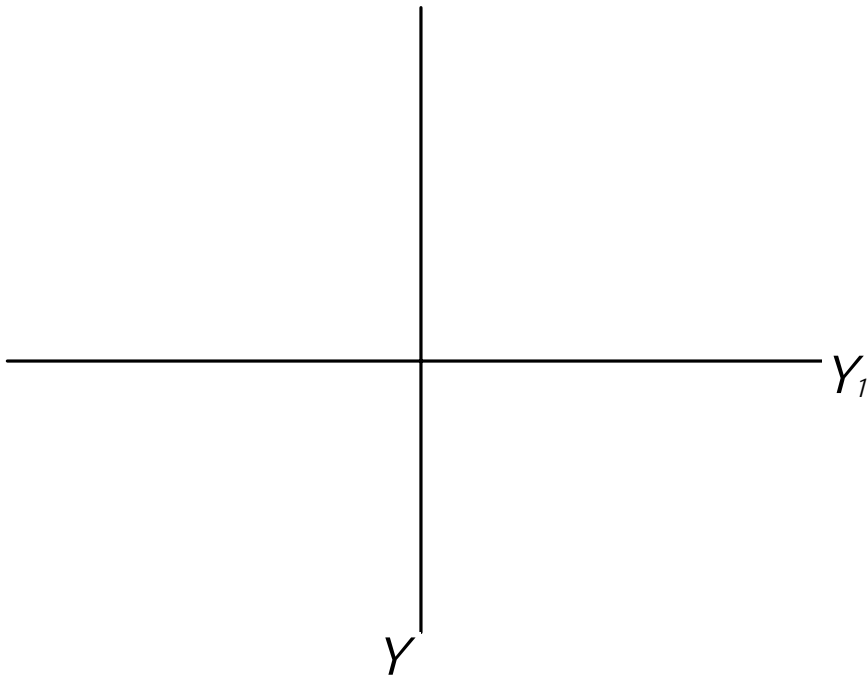
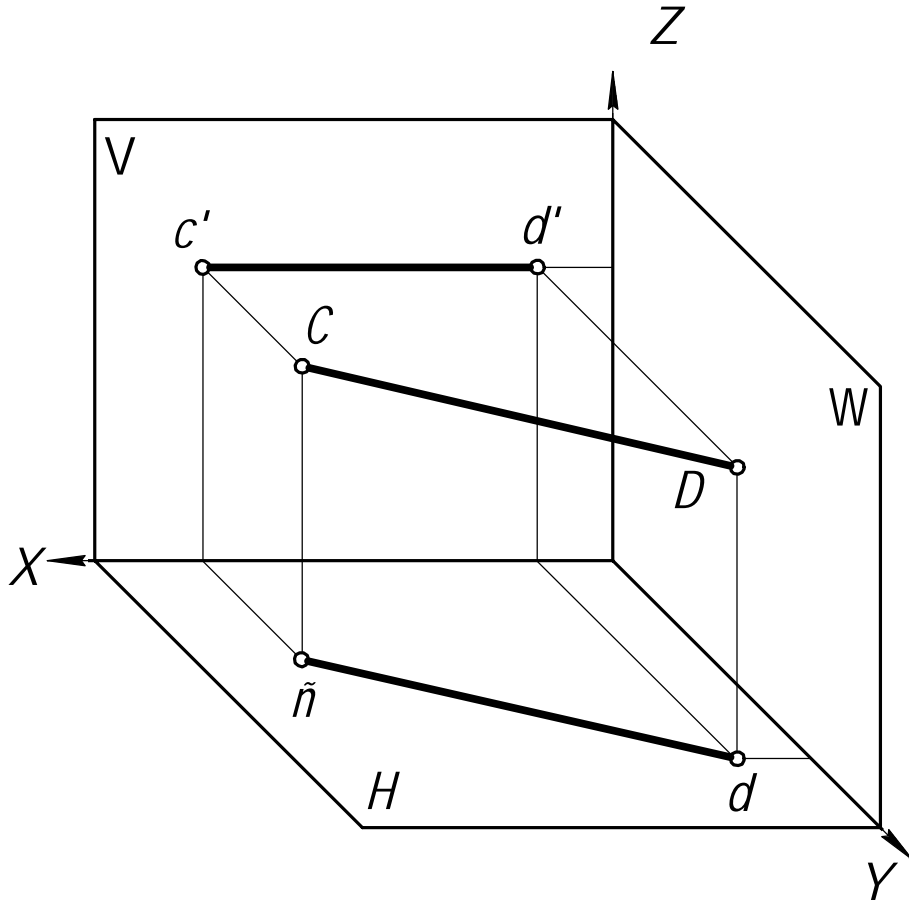

ἰὸῖ. è äàòà
Èíà. 1 äàè.
Ãçàí. èíà. 1
ἰὸῖ. è äàòà
Èíà. 1 ἰῖàè.

Èçì.	Èèñò	1 äíèóì.	ἰὸῖ.	Ãàòà
------	------	----------	------	------

ἰδῖ ἀεὸ ἐὲ ἰδῖ ἰέ

Ὀδῖ ἰ δὰ εὐῖ ἰέ ἐεῖ ἰέ ὄδῖ ἰέ

Ὀδῖ ἰ δὰ εὐῖ ἰέ ἐεῖ ἰέ ὄδῖ ἰέ

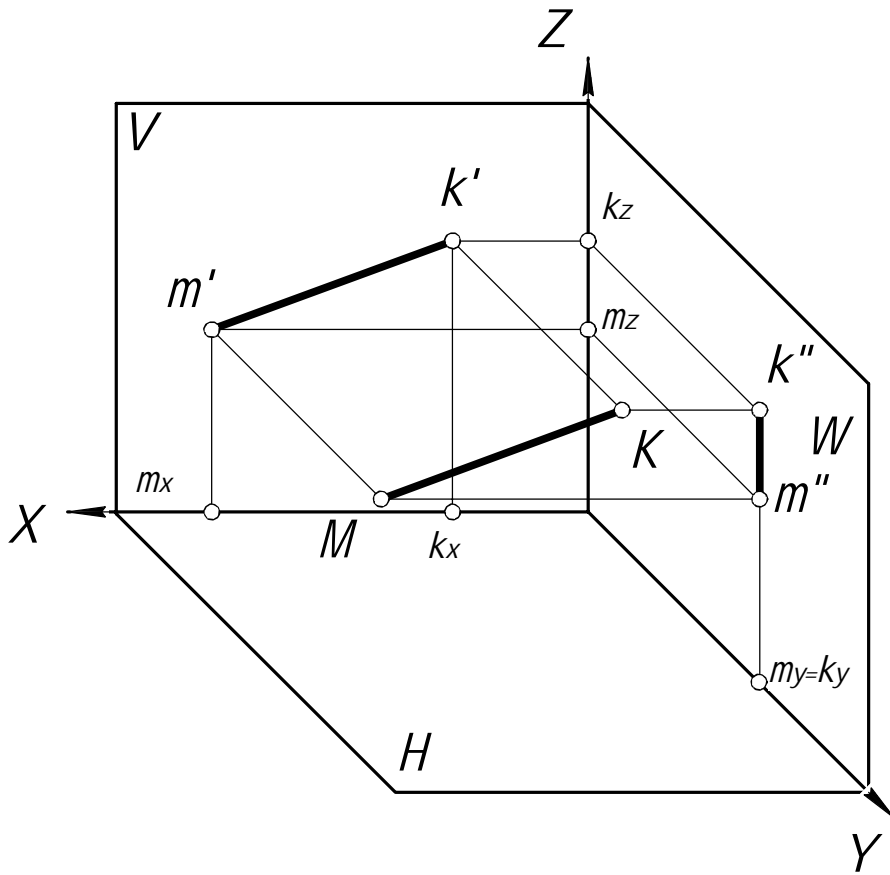

Νᾱῖ ἐὸ δὰ ὄδῖ ἰ δὰ εὐῖ ἰέ
ἐεῖ ἐὲ ὄδῖ ἰέ

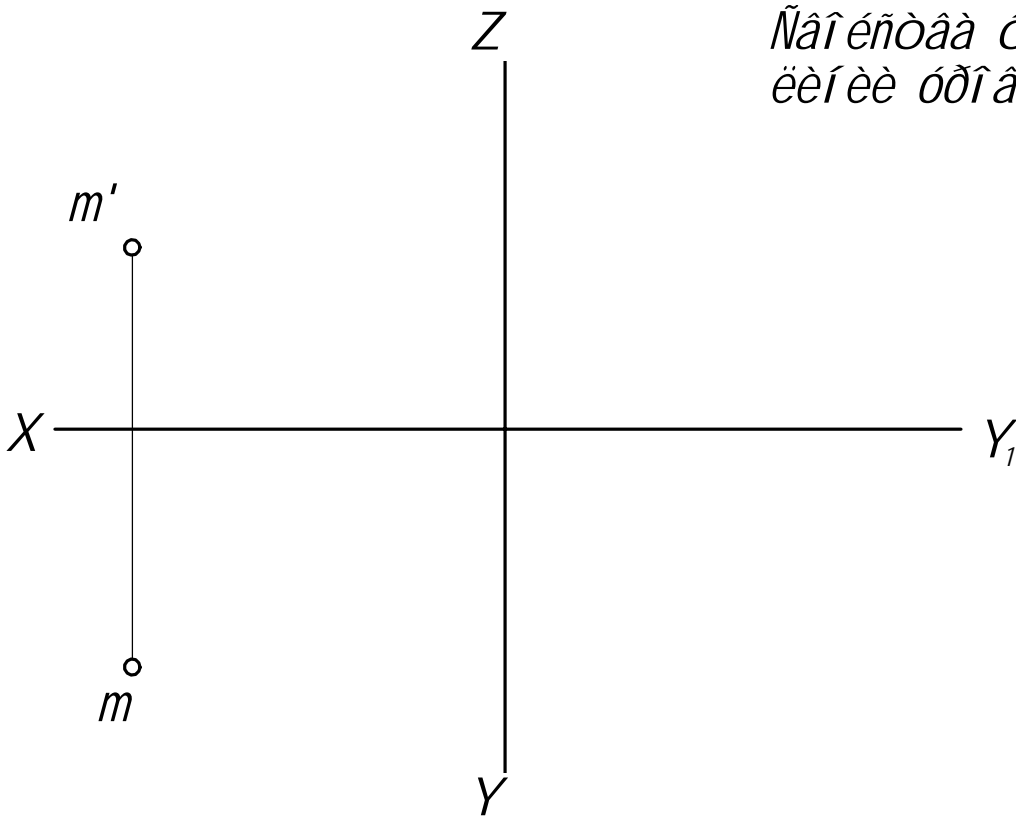

Ἐῖ ἰ ἰῖᾶε.	ἰῖᾶῖ. ἐ ἰᾶδᾶ	Ἀῖᾶῖ. ἐῖ ἰᾶ. ἰ	Ἐῖ ἰ ἰᾶᾶᾶ.	ἰῖᾶῖ. ἐ ἰᾶδᾶ
Ἐῖ ἰ ἰᾶᾶᾶ.	ἰῖᾶῖ. ἐ ἰᾶδᾶ	ἰῖᾶῖ. ἐ ἰᾶ. ἰ	Ἐῖ ἰ ἰᾶᾶᾶ.	ἰῖᾶῖ. ἐ ἰᾶδᾶ
Ἐῖ ἰ ἰᾶᾶᾶ.	ἰῖᾶῖ. ἐ ἰᾶδᾶ	ἰῖᾶῖ. ἐ ἰᾶ. ἰ	Ἐῖ ἰ ἰᾶᾶᾶ.	ἰῖᾶῖ. ἐ ἰᾶδᾶ

Ἐῖ ἰ ἰᾶᾶᾶ.	Ἐῖ ἰ ἰᾶᾶᾶ.	ἰ ἰᾶᾶᾶῖ.	ἰῖᾶῖ.	Ἀῖᾶδᾶ
------------	------------	----------	-------	-------

ἰδῖ ἀεὸ ἐὲ ἰδῖ ἰέ

ἰδῖ ὀεῖῦί ἄῦ ἔεῖ ἔῦ ὀδῖ ἄίῦ

$\hat{I} \hat{D} \hat{I} \hat{O} \hat{E} \hat{E} \hat{U} \hat{I} \hat{A} \hat{Y} \hat{E} \hat{E} \hat{I} \hat{E} \hat{Y} \hat{O} \hat{D} \hat{I} \hat{A} \hat{I} \hat{Y} [FE] \parallel W$

$\hat{I} \hat{D} \hat{I} \hat{O} \hat{E} \hat{E} \hat{U} \hat{I} \hat{A} \hat{Y} \hat{E} \hat{E} \hat{I} \hat{E} \hat{Y} \hat{O} \hat{D} \hat{I} \hat{A} \hat{I} \hat{Y}$ -

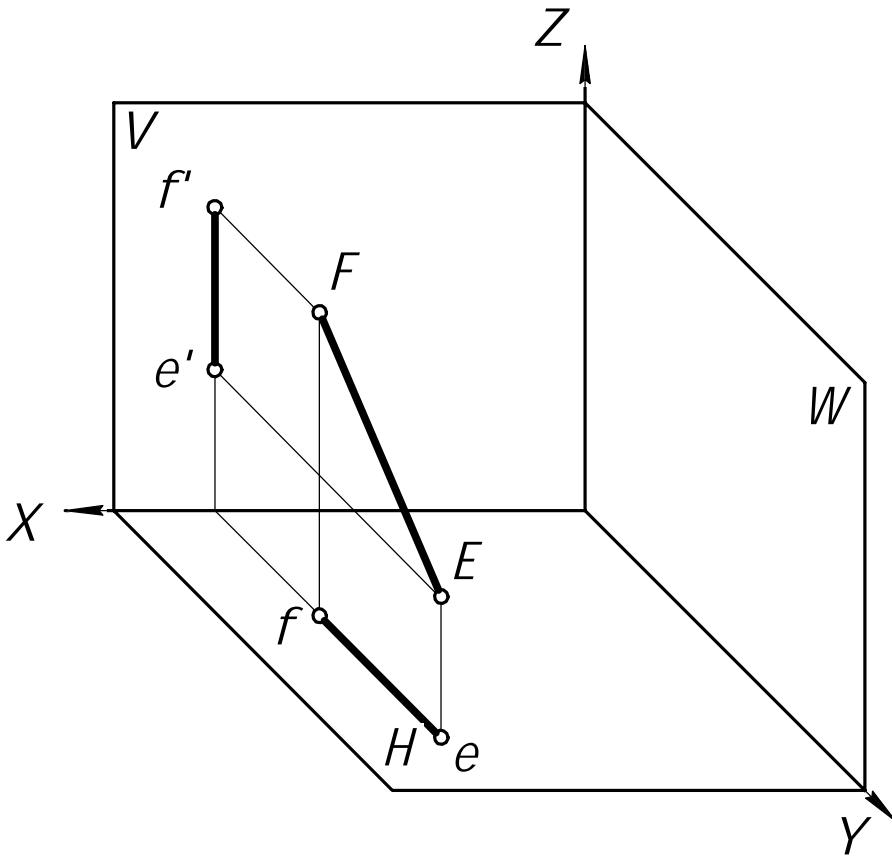

$\tilde{N} \hat{I} \hat{E} \hat{N} \hat{O} \hat{A} \hat{A} \hat{I} \hat{D} \hat{I} \hat{O} \hat{E} \hat{E} \hat{U} \hat{I} \hat{E} \hat{E} \hat{I} \hat{E} \hat{E} \hat{O} \hat{D} \hat{I} \hat{A} \hat{I} \hat{Y}$

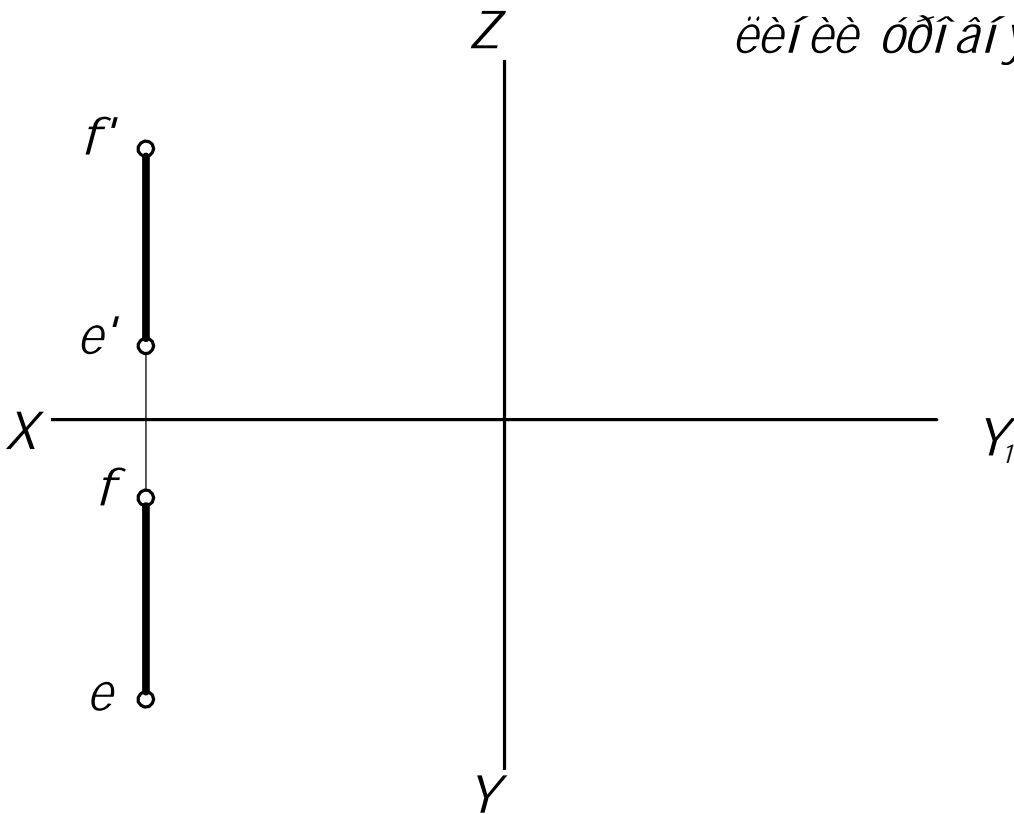

$\hat{I} \hat{A} \hat{I} \hat{E} \hat{A} \hat{O} \hat{A}$
$\hat{E} \hat{I} \hat{A} \hat{I} \hat{A} \hat{O} \hat{A} \hat{E}$
$\hat{A} \hat{C} \hat{A} \hat{I} \hat{E} \hat{I} \hat{A} \hat{I}$
$\hat{I} \hat{A} \hat{I} \hat{E} \hat{A} \hat{O} \hat{A}$
$\hat{E} \hat{I} \hat{A} \hat{I} \hat{I} \hat{A} \hat{E}$

$\hat{I} \hat{D} \hat{I} \hat{A} \hat{E} \hat{O} \hat{E} \hat{E} \hat{I} \hat{D} \hat{Y} \hat{I} \hat{I} \hat{E}$

$\hat{E} \hat{E} \hat{N} \hat{O}$
7

Ἐπίπεδα ἑπιπέδων ὁρίζονται -

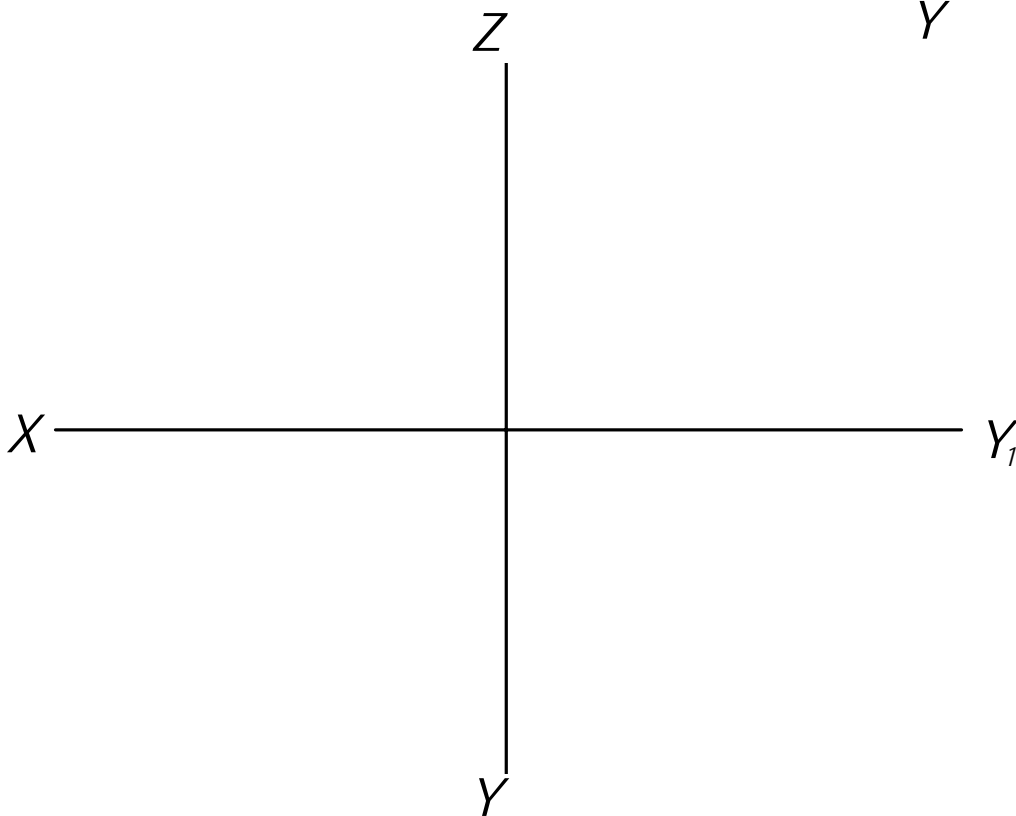
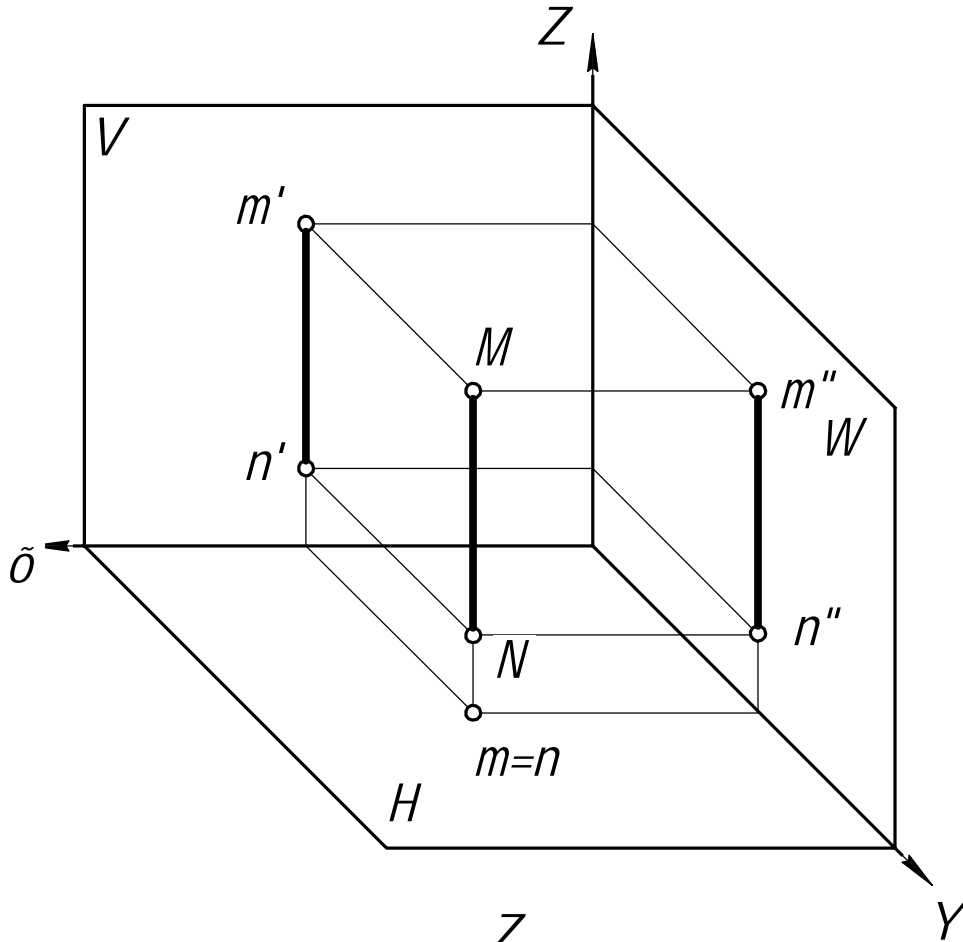

Ἐπίπεδα ἑπιπέδων	Ἐπίπεδα ἑπιπέδων	Ἐπίπεδα ἑπιπέδων	Ἐπίπεδα ἑπιπέδων	Ἐπίπεδα ἑπιπέδων
Ἐπίπεδα ἑπιπέδων	Ἐπίπεδα ἑπιπέδων	Ἐπίπεδα ἑπιπέδων	Ἐπίπεδα ἑπιπέδων	Ἐπίπεδα ἑπιπέδων

Ἐπίπεδα ἑπιπέδων	Ἐπίπεδα ἑπιπέδων	Ἐπίπεδα ἑπιπέδων	Ἐπίπεδα ἑπιπέδων	Ἐπίπεδα ἑπιπέδων
Ἐπίπεδα ἑπιπέδων	Ἐπίπεδα ἑπιπέδων	Ἐπίπεδα ἑπιπέδων	Ἐπίπεδα ἑπιπέδων	Ἐπίπεδα ἑπιπέδων

ε ι λ ρ ι ε ε ο ε ρ ι ο ι

Ãî ðèçî í ðàèüí î - î ðî åöèðòù àÿ î ðÿì àÿ

Ãî ðèçî í ðàèüí î - î ðî åöèðòù àÿ î ðÿì àÿ -

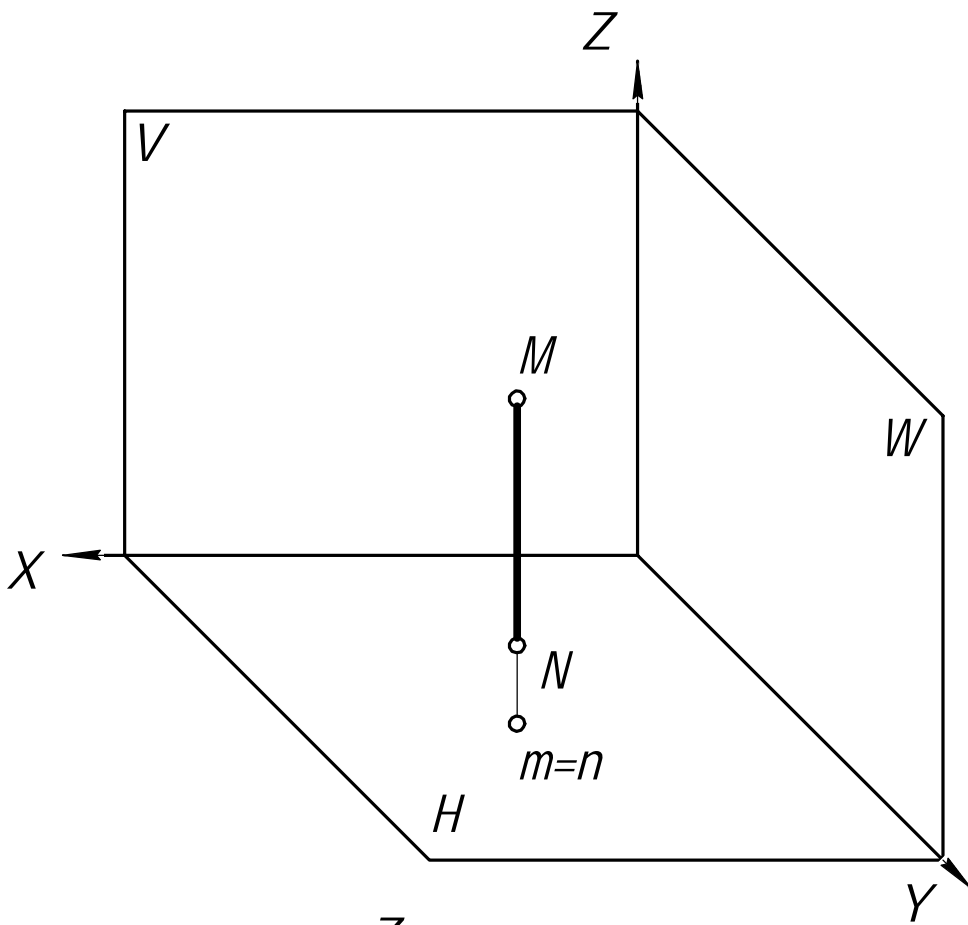

Ñâî êñòáà áî ðèçî í ðàèüí î -
î ðî åöèðòù áé î ðÿì î é

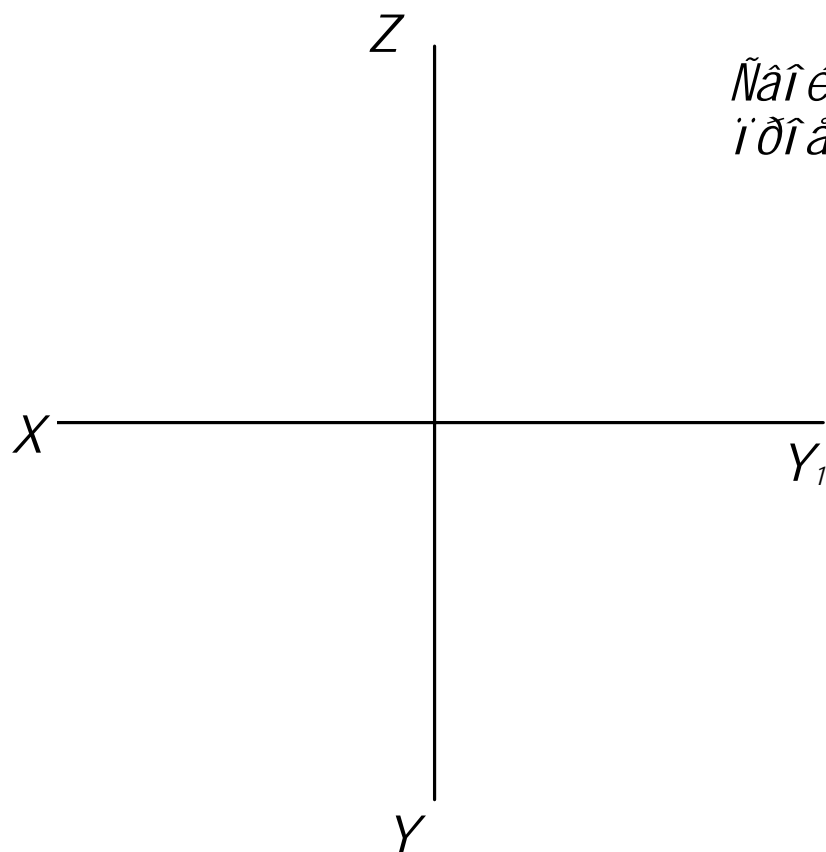

Îñî. è áàòà
Ëñà. 1 áàè
Ãçàî. èñà. 1
Îñî. è áàòà
Ëñà. 1 ðñàè

Ëçì. Ëèñò	1 áñèóì.	Îñî.	Ãàòà
-----------	----------	------	------

Î ðî åèöèè î ðÿì î é

Ëèñò
9

ΘΙ ΙΥΡΙ ΕΑΘΘΙΘΙ

Ôðîí òàëüíî - îðîáëèðùàÿ ïðÿì àÿ

Ôðîí òàëüíî - îðîáëèðùàÿ ïðÿì àÿ -

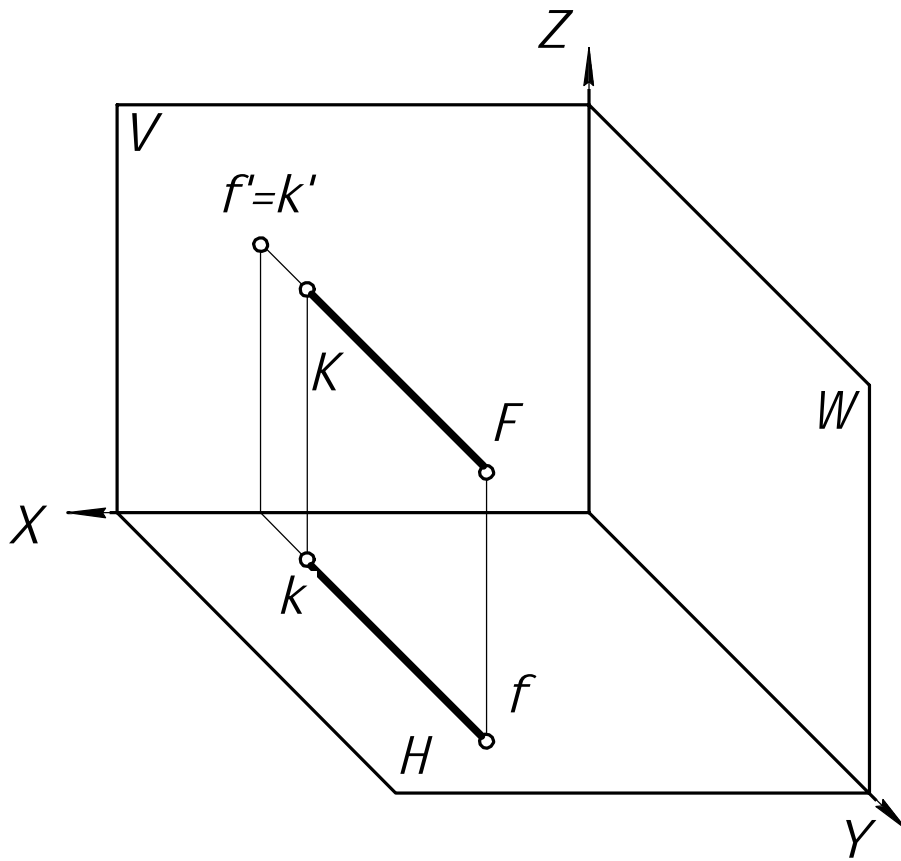

Ñâî éñòàà òðîí òàëüíî -
îðîáëèðùàé ïðÿì îé

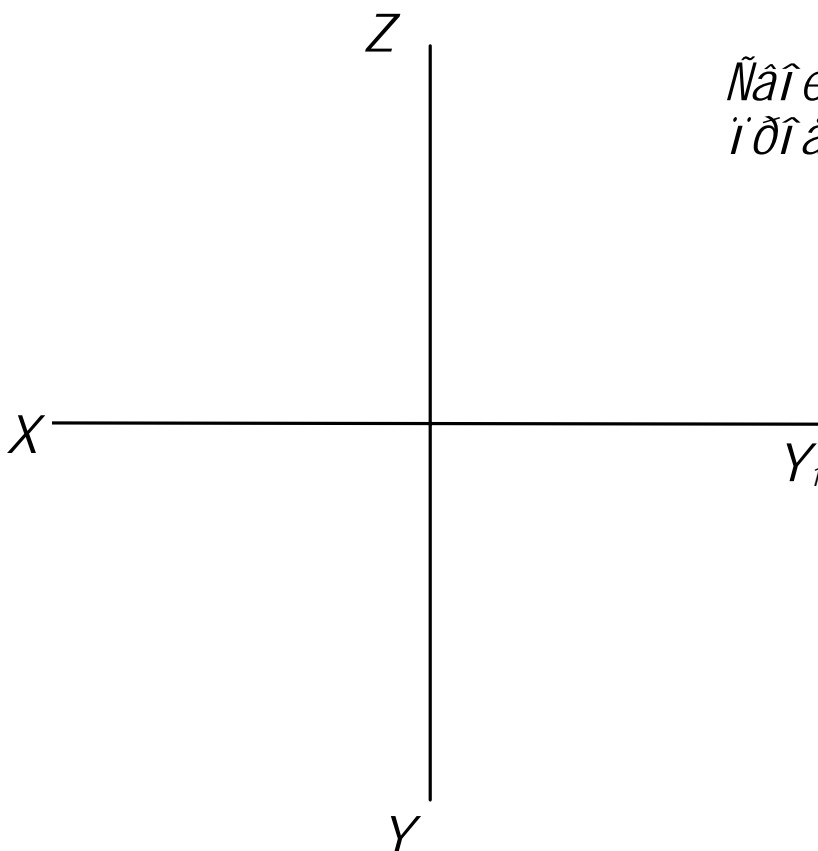

Éíá ¹ ïñáé.	Íñáì. è ààòá	Áçáì. è íá. ¹	Éíá. ¹ áòáé.	Íñáì. è ààòá
Éçì. Èéñò	¹ áñéòì.	Íñáì.	Áàòá	

Ìðîáëèðùàé ïðÿì îé

ἰδίωτες ἀλλήλων

ἰδίωτες ἀλλήλων - ἰδίωτες ἀλλήλων ἰδίωτες ἀλλήλων

ἰδίωτες ἀλλήλων - ἰδίωτες ἀλλήλων ἰδίωτες ἀλλήλων -

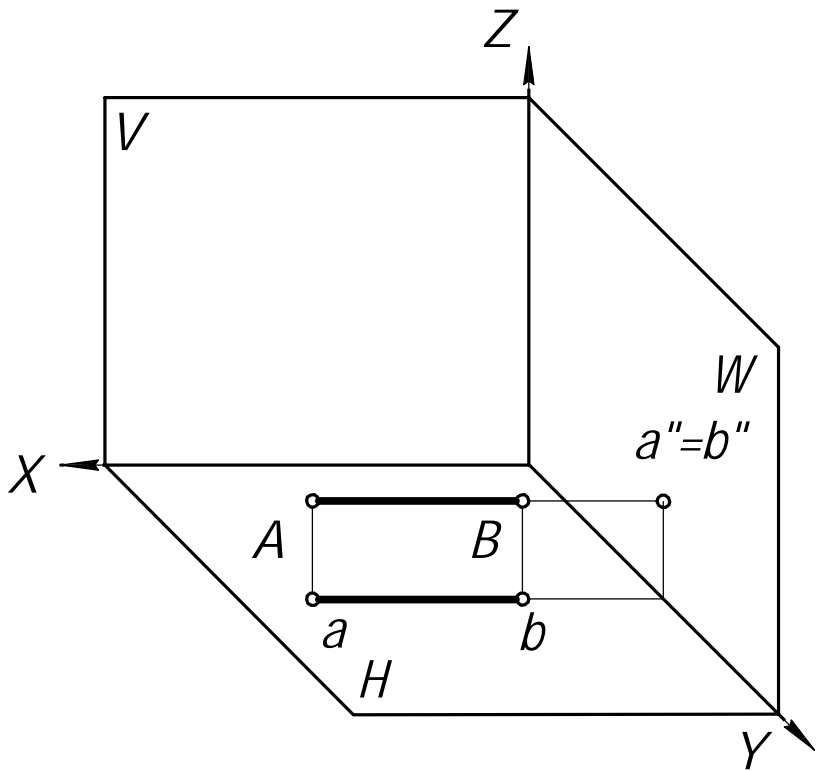

ἰδίωτες ἀλλήλων ἰδίωτες ἀλλήλων ἰδίωτες ἀλλήλων ἰδίωτες ἀλλήλων

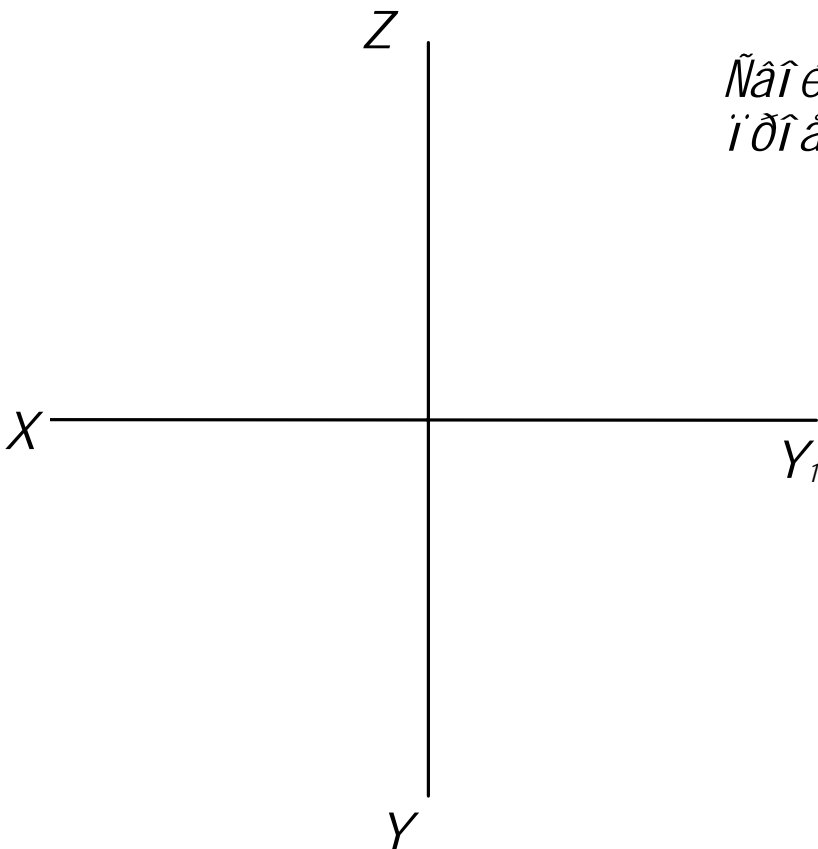

ἰδίωτες ἀλλήλων
ἰδίωτες ἀλλήλων
ἰδίωτες ἀλλήλων
ἰδίωτες ἀλλήλων
ἰδίωτες ἀλλήλων

ἰδίωτες ἀλλήλων	ἰδίωτες ἀλλήλων	ἰδίωτες ἀλλήλων	ἰδίωτες ἀλλήλων
ἰδίωτες ἀλλήλων	ἰδίωτες ἀλλήλων	ἰδίωτες ἀλλήλων	ἰδίωτες ἀλλήλων

ἰδίωτες ἀλλήλων ἰδίωτες ἀλλήλων

ἰδίωτες ἀλλήλων
11

ΘΥΙΛΥΘΙ ΕΘΘΕΘΙ ΘΥΙΛΥΘΙ

Άσὰὲὶ ἰῖὰ ἰῖἔἰᾶἰᾶ ὀῖ:ἔἔ ἔ ἰῖῖἰ ἰἔ

Ἰῖἔῖἰᾶἔ ἰῖἔἰᾶἔἔἔἰᾶἰᾶ ὀῖ:ἔἔ ἔ ἰῖῖἰ ἰἔ -

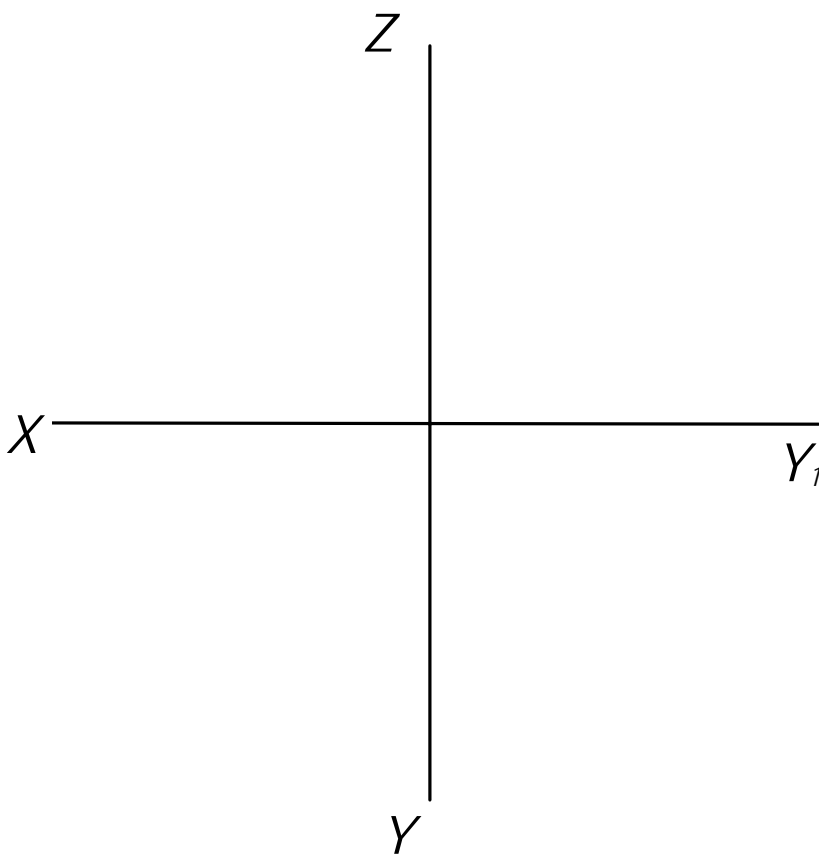
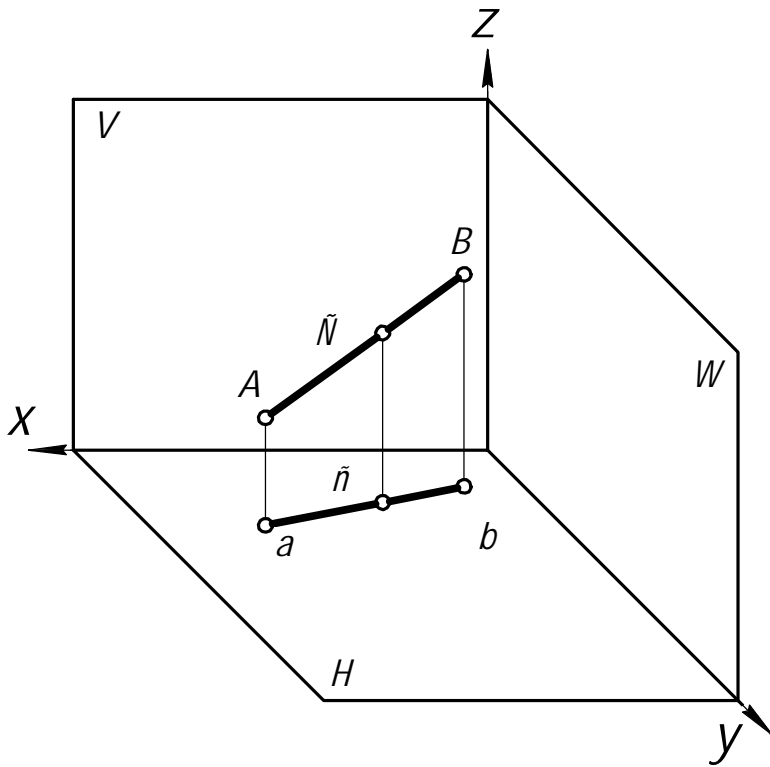

Ἐἰᾶ ἰῖᾶἔ	Ἰῖᾶἰ: ἔ ἄῶῶᾶ	Ἄσᾶἰ. ἔἰᾶ ἰ	Ἐἰᾶ ἰ ἄῶᾶἔ	Ἰῖᾶἰ: ἔ ἄῶῶᾶ
Ἐῖῖ. Ἐἔῖῖ	ἰ ἄῖἔῖῖ.	Ἰῖᾶἰ.	Ἄῶῶᾶ	

Ἰῖῖᾶἔῶῶἔ ἰῖῖἰ ἰἔ

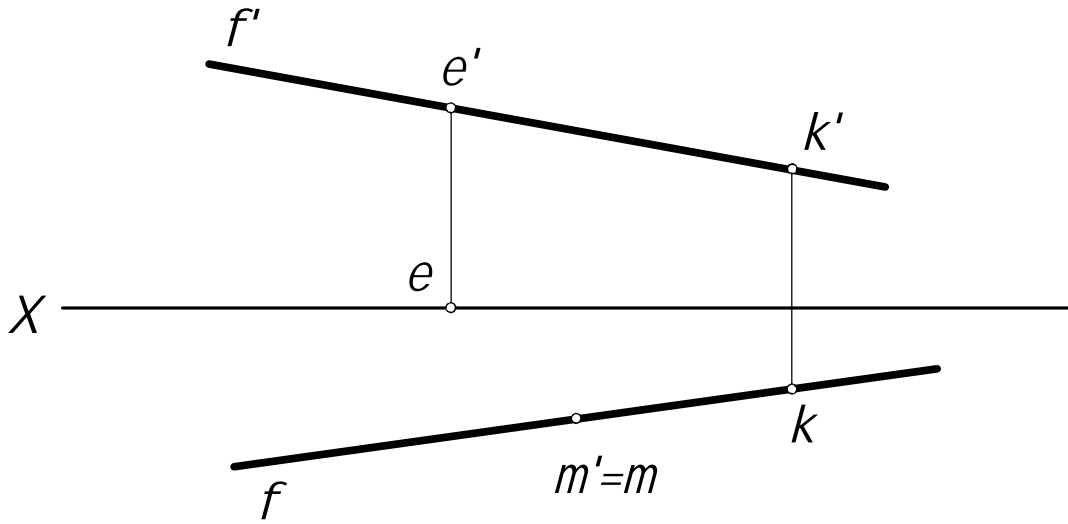

Συνθήκη ἰσομετρίας

Ἐπιπέδου ἰσομετρίας -

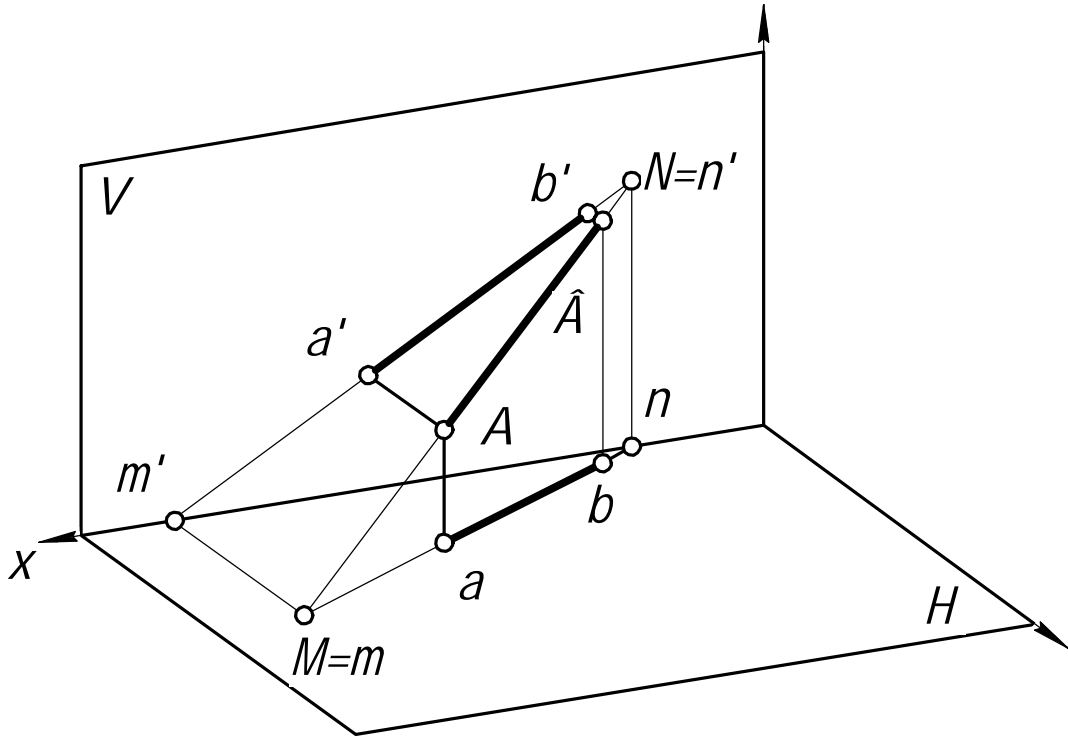

Ἰδιότητες ἰσομετρίας
Ἐπίπεδο ἰσομετρίας
Ἐπίπεδο ἰσομετρίας
Ἐπίπεδο ἰσομετρίας
Ἐπίπεδο ἰσομετρίας

Ἐπίπεδο	Ἐπίπεδο	Ἐπίπεδο	Ἐπίπεδο
Ἐπίπεδο	Ἐπίπεδο	Ἐπίπεδο	Ἐπίπεδο

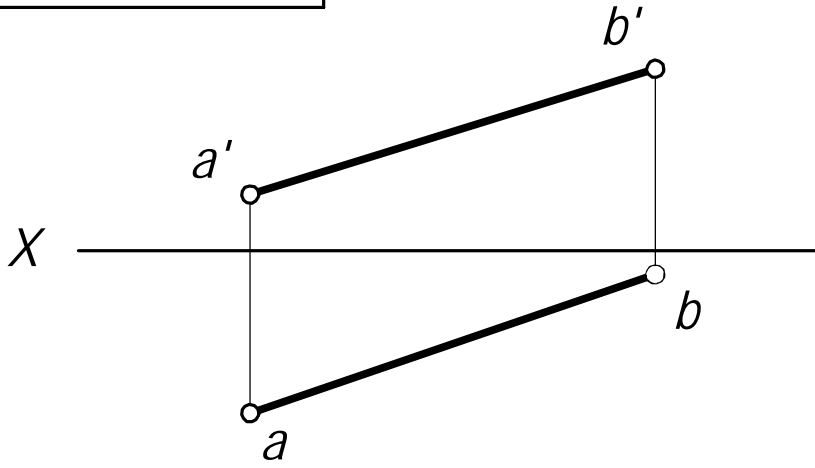

Àëãîðèòì ìîñòðîáíëÿ ñëããîã ìðÿì îé -

Íðÿì àÿ îáùããî ìîëîæáíëÿ â ñëñòàì á òðãõ ìëîñëîñòãë èìããò

Ëèíëÿ óðîáíÿ

Íðîãëðòòòàÿ ìðÿì àÿ

Âçàèì îîã ìîëîæáíëãããóò ìðÿì ùõ

Ããã ìðÿì ùã â ìðîñòðáíñòãã ìîãóò áùòù

Íàðãëëãëüí ùã ìðÿì ùã

Íðèçíãë ìàðãëëãëüíîñòè -

Íðîá. èããòã	Íðîá. èããòã	Íðîá. èããòã	Íðîá. èããòã	Íðîá. èããòã
Ëíã. èããòã	Ëíã. èããòã	Ëíã. èããòã	Ëíã. èããòã	Ëíã. èããòã
Ëíã. èããòã	Ëíã. èããòã	Ëíã. èããòã	Ëíã. èããòã	Ëíã. èããòã
Ëíã. èããòã	Ëíã. èããòã	Ëíã. èããòã	Ëíã. èããòã	Ëíã. èããòã

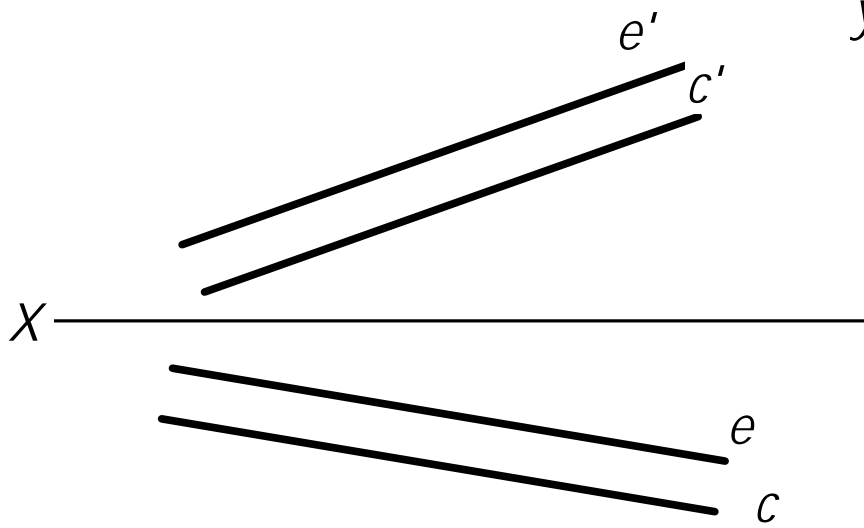
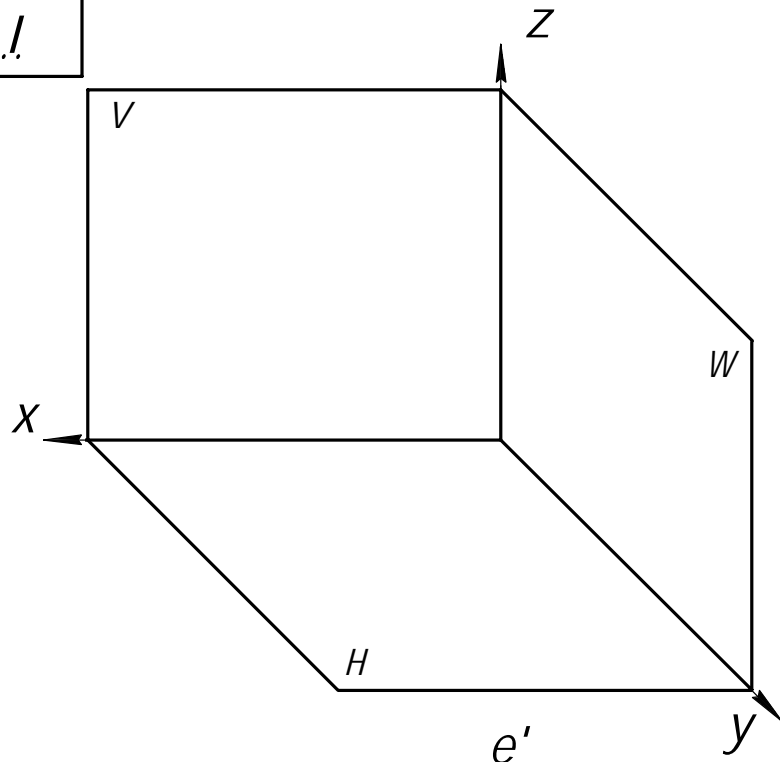

Ἰὰδᾶεῖᾶεῦἰἱἡὸὲ ᾶᾶὄ ἱᾶἱἱὲἰ ᾶἱἱῦὄ ἰδῖᾶεὐὲ

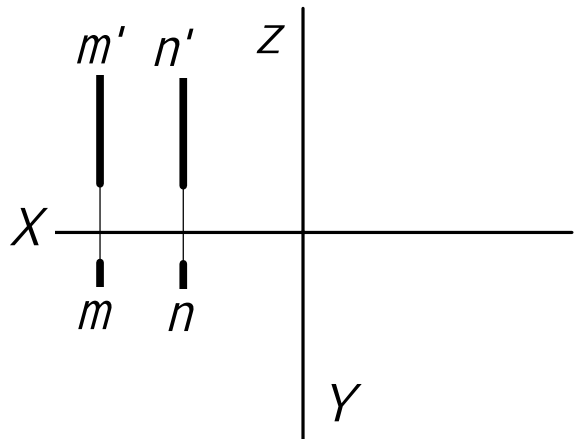
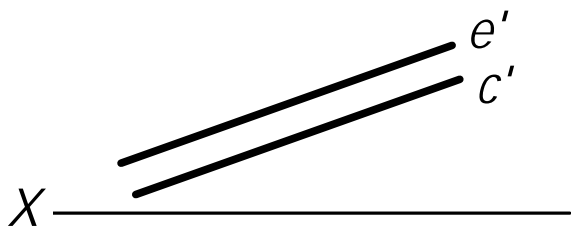

Ἰᾶἱ. ἲ ᾶᾶὲ
Ἰᾶ. 1 ᾶᾶὲ
Ἀᾶἱ. ἲᾶ. 1
Ἰᾶἱ. ἲ ᾶᾶὲ
Ἰᾶ. 1 ἱᾶᾶ

Ἐᾶ. Ἰᾶᾶ	1 ᾶᾶᾶἱ.	Ἰᾶἱ.	Ἀᾶὲ
---------	---------	------	-----

Ἰδῖᾶεὐὲ ἰδὺι ἱέ

Ἰδὲçí ᾶε ἰἀδᾶñᾶεᾶρὺεᾶñý ἰδýì ùᾶ -

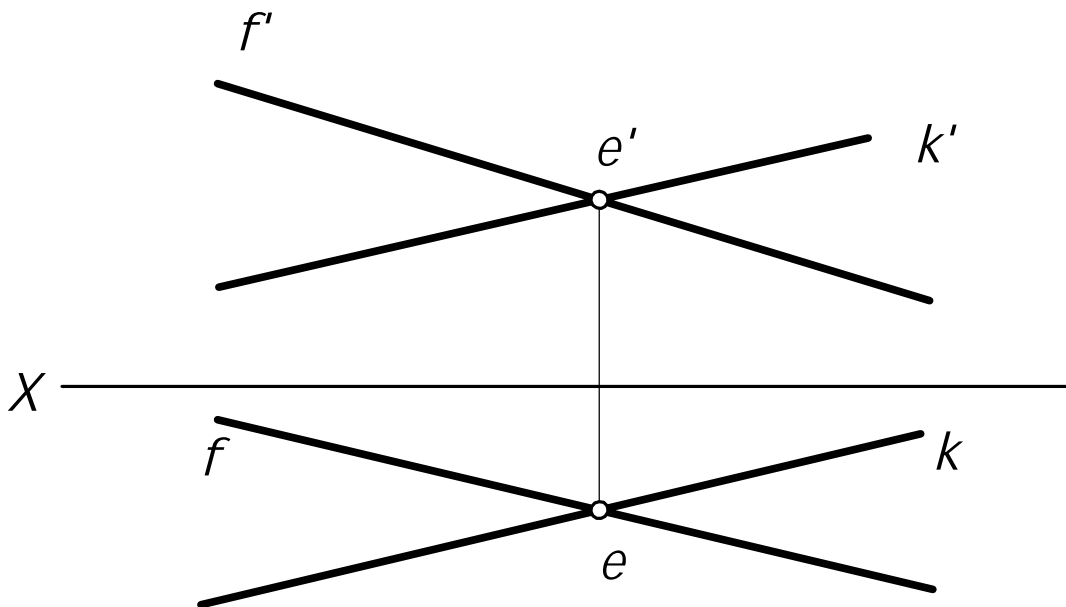
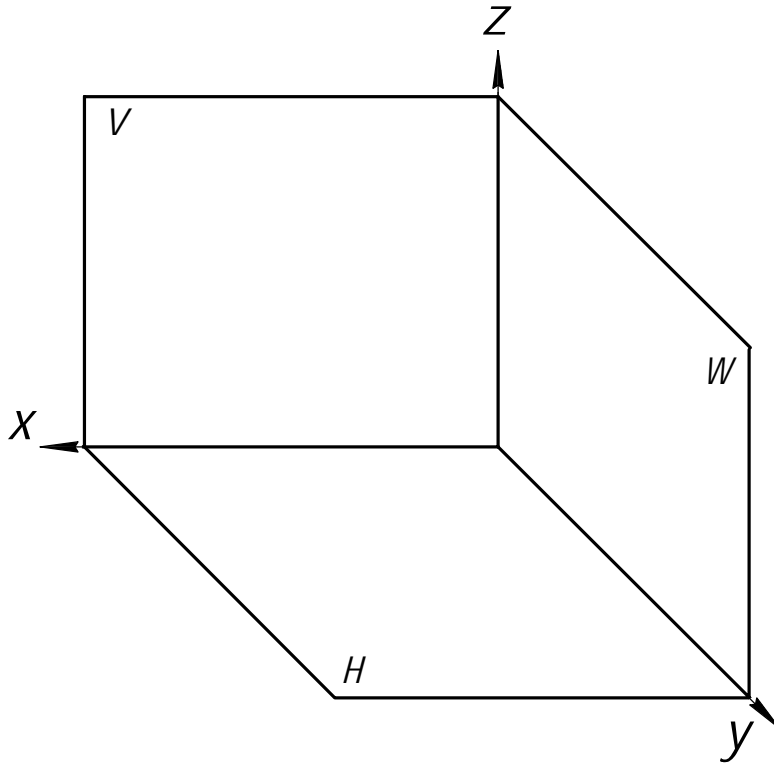

Ἐἰᾶ ἰ ἰᾶε.	Ἰᾶἰ. ἔ ᾶᾶᾶ	Ἀçᾶἰ. ἔἰᾶ ἰ	Ἐἰᾶ ἰ ᾶᾶé.	Ἰᾶἰ. ἔ ᾶᾶᾶ
Ἐçì. Ἐεñᾶ	ἰ ᾶἰεᾶἰ.	Ἰᾶἰ.	Ἀᾶᾶ	

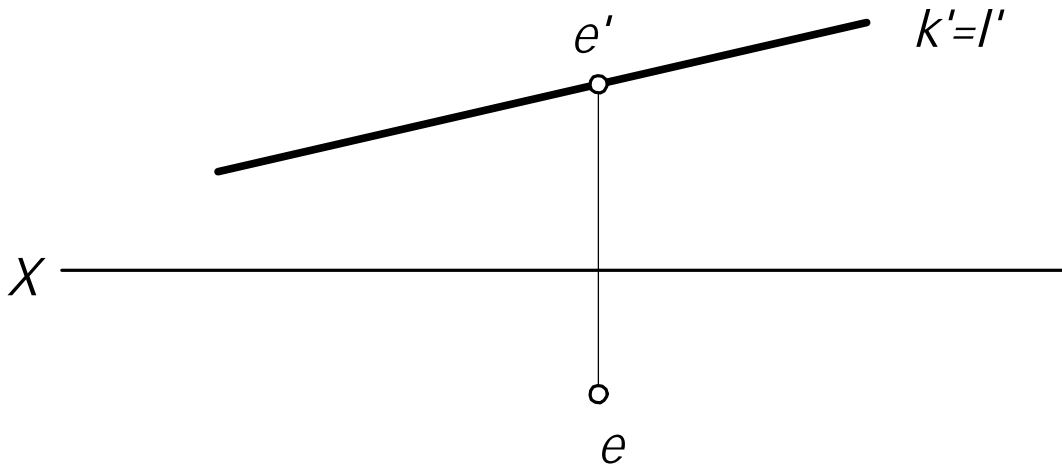

Ἡ δὲ ἀπόδειξις τῆς ἰσοπλάτου

ἰσοπλάτου ἀποδείξις τῆς ἰσοπλάτου -

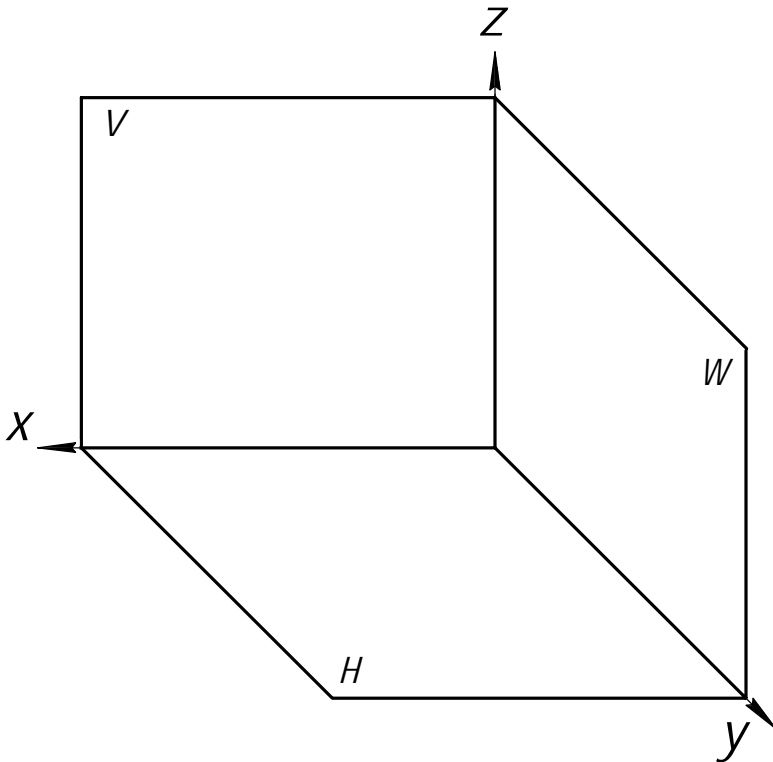

Ἰδιότητες ἰσοπλάτων	Ἐπίπεδα ἰσοπλάτων	Ἄλλα ἰδιότητες ἰσοπλάτων	Ἰδιότητες ἰσοπλάτων	Ἐπίπεδα ἰσοπλάτων
---------------------	-------------------	--------------------------	---------------------	-------------------

Ἐπίπεδα	Ἐπίπεδα	Ἄλλα ἰδιότητες	Ἰδιότητες	Ἄλλα ἰδιότητες
---------	---------	----------------	-----------	----------------

ἰδῆσθὲ ἰδῆτε

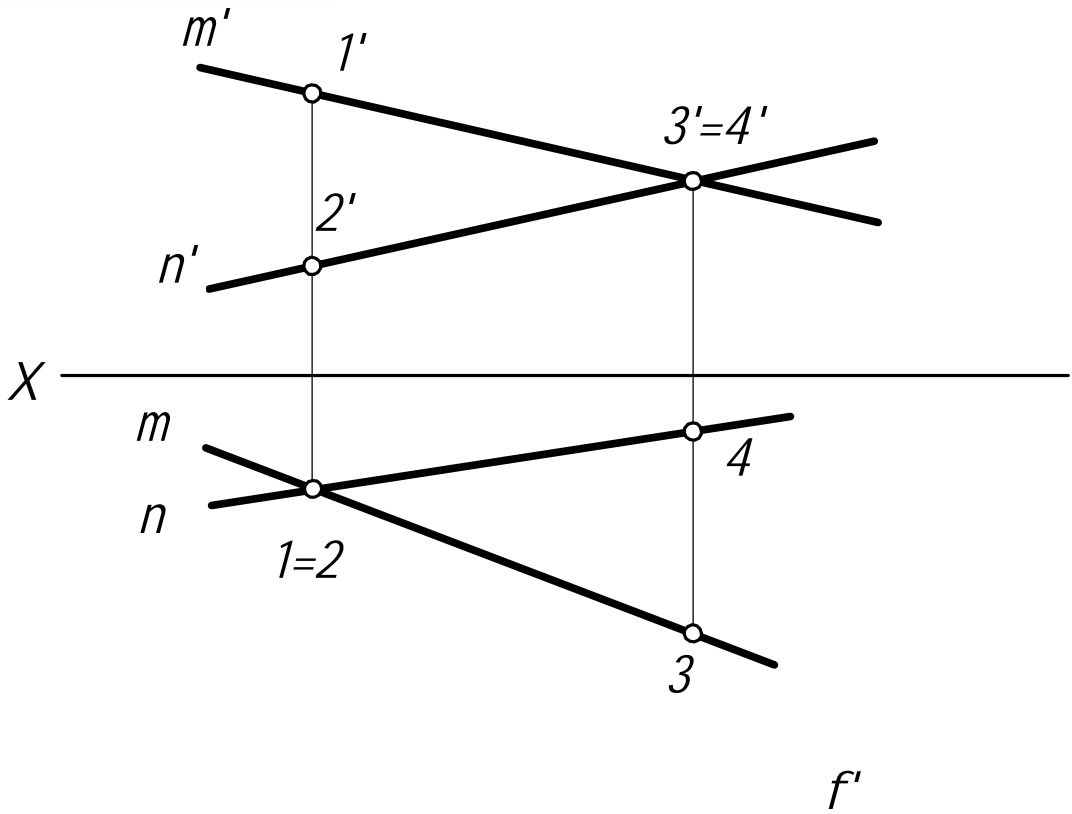

à ἰῆσὸ ἀὺδὺ ἰὰδᾶεῖᾶεῦἰῦ

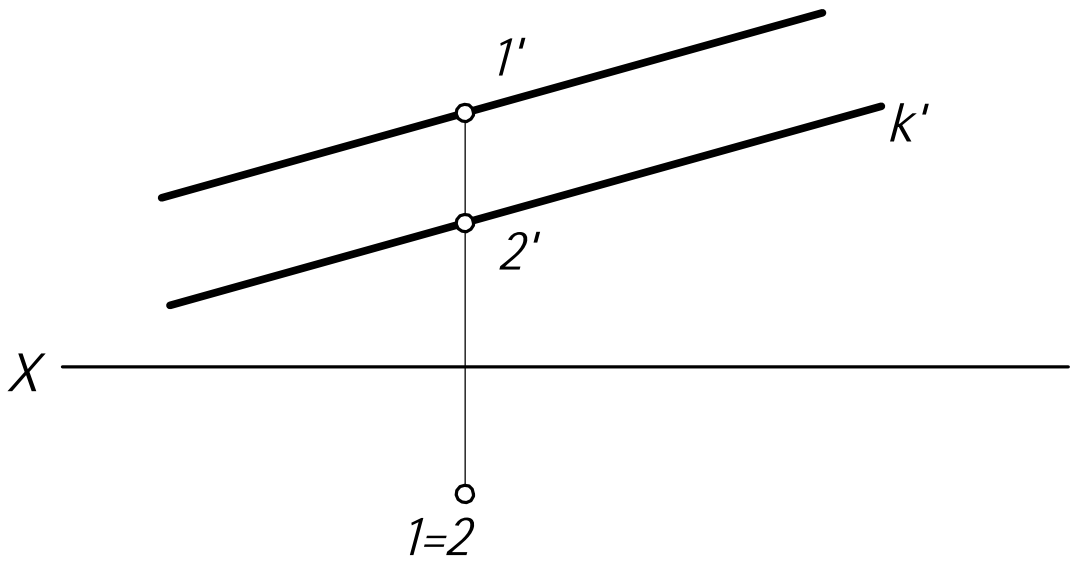

Ἐῖᾶ ἰ ἰῆᾶε.	ἰῆᾶἰ. ἔ ᾶᾶᾶ	Ἀῖᾶἰ. ἔῖᾶ ἰ	Ἐῖᾶ ἰ ᾶᾶᾶ.	ἰῆᾶἰ. ἔ ᾶᾶᾶ
Ἐῖᾶ. Ἐῖᾶᾶ		ἰ ᾶῖᾶᾶἰ.	ἰῆᾶἰ.	Ἀᾶᾶ

Ἐῖᾶ. Ἐῖᾶᾶ	ἰ ᾶῖᾶᾶἰ.	ἰῆᾶἰ.	Ἀᾶᾶ	

ἰδῆσθὲ ἰδῆτε

Ἐῖᾶᾶ

18

Ἄνεῃ ἀὰ ἀὰ ἀὰ ἰδιῶτε ἰδιῶτε ἰδιῶτε ἰδιῶτε ἰδιῶτε

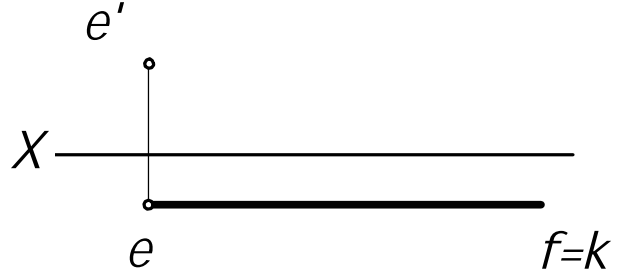
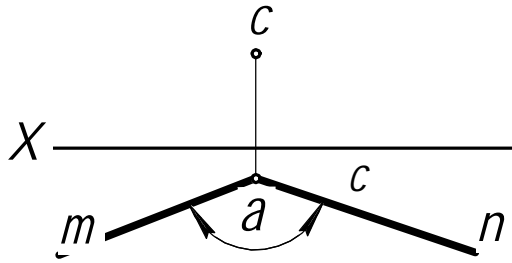

Ἄνεῃ ἰδιῶτε ἰδιῶτε ἰδιῶτε ἰδιῶτε ἰδιῶτε ἰδιῶτε ἰδιῶτε ἰδιῶτε ἰδιῶτε

Ἄνεῃ ἰδιῶτε ἰδιῶτε ἰδιῶτε ἰδιῶτε ἰδιῶτε ἰδιῶτε ἰδιῶτε ἰδιῶτε ἰδιῶτε

Ἄνεῃ ἰδιῶτε ἰδιῶτε ἰδιῶτε ἰδιῶτε ἰδιῶτε ἰδιῶτε ἰδιῶτε ἰδιῶτε ἰδιῶτε

ἰδιῶτε ἰδιῶτε
ἰδιῶτε ἰδιῶτε
ἰδιῶτε ἰδιῶτε
ἰδιῶτε ἰδιῶτε
ἰδιῶτε ἰδιῶτε

ἰδιῶτε ἰδιῶτε	ἰδιῶτε ἰδιῶτε	ἰδιῶτε ἰδιῶτε	ἰδιῶτε ἰδιῶτε
ἰδιῶτε ἰδιῶτε	ἰδιῶτε ἰδιῶτε	ἰδιῶτε ἰδιῶτε	ἰδιῶτε ἰδιῶτε

Ἰδιότητες ἰσότητας

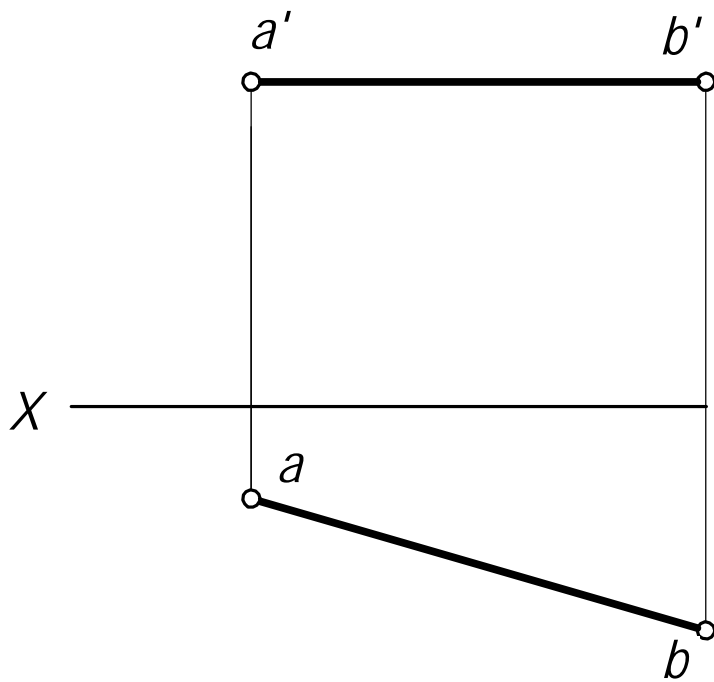
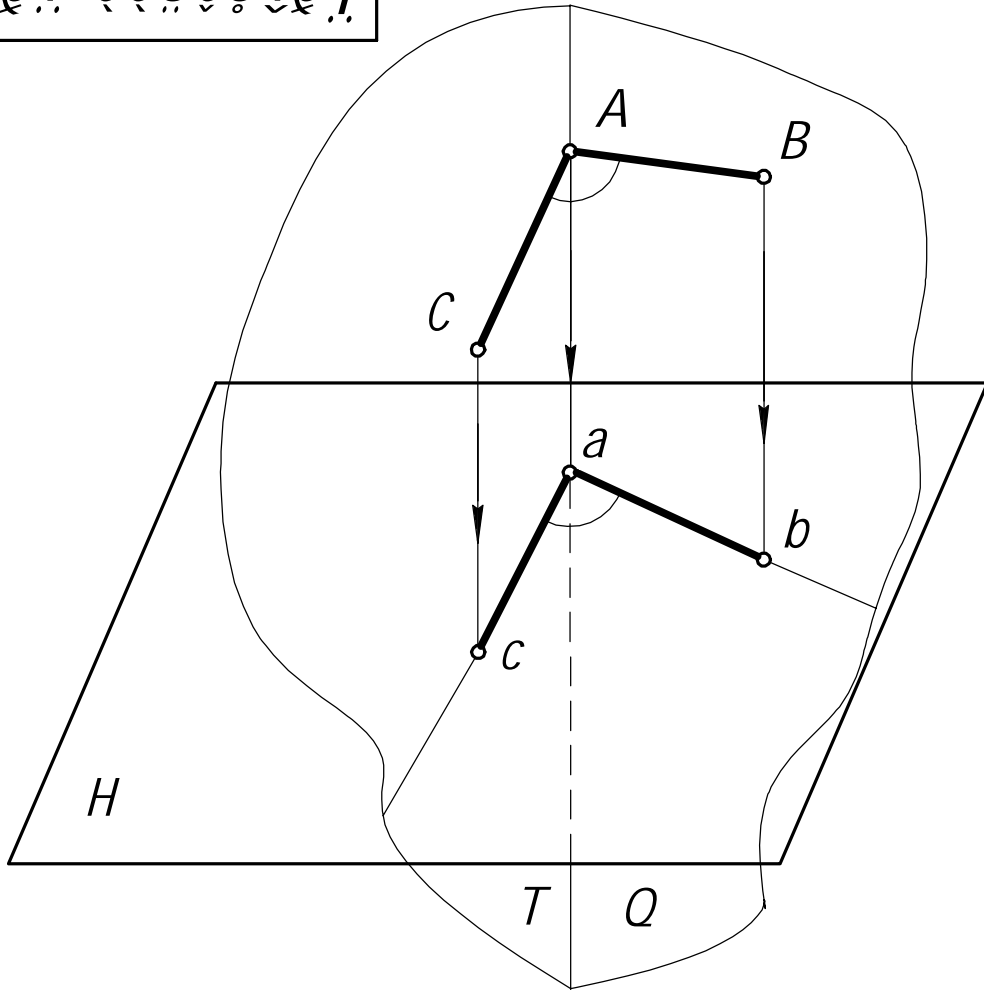

Ἐἷα ἰ ἰῖαέ.	Ἰῖῖῖ. ἔ ἔααα	Ἀαῖῖ. ἔῖῖ. ἰ	Ἐῖῖ. ἰ ἰῖῖῖ.	Ἰῖῖῖ. ἔ ἔααα
Ἐῖῖ. Ἐῖῖῖ	ἰ ἰῖῖῖ.	Ἰῖῖῖ.	Ἀααα	

Ἰδιότητες ἰσότητας

Ἐῖῖῖ

20

Ñîîñîáú çàääíëÿ ĭ'ēîñēîñòè íà ÷åðòååâ

1. Õðãîÿ òî÷èàî è, íå äåæàùèè è íà îäíîé ĭ'ðÿî îé

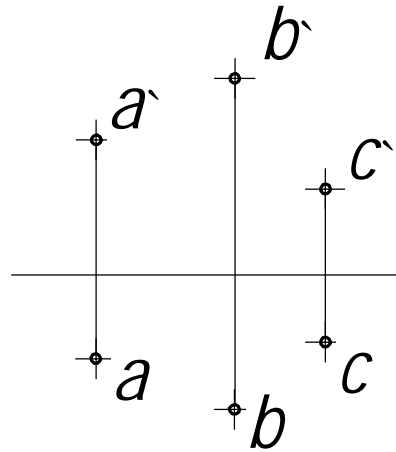
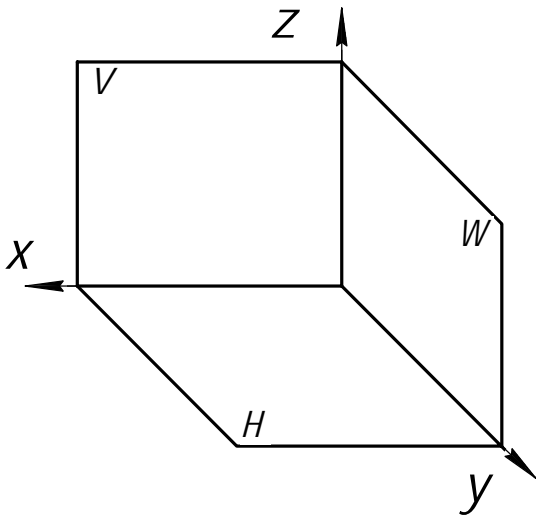

2. Õî÷èîé è ĭ'ðÿî îé, íå äåæàùåé íà ÿòîé ĭ'ðÿî îé

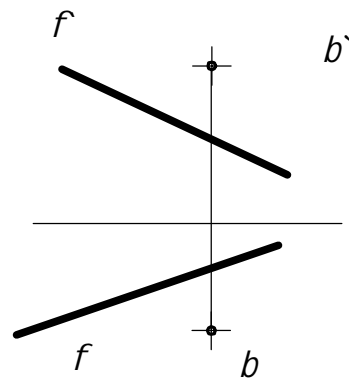
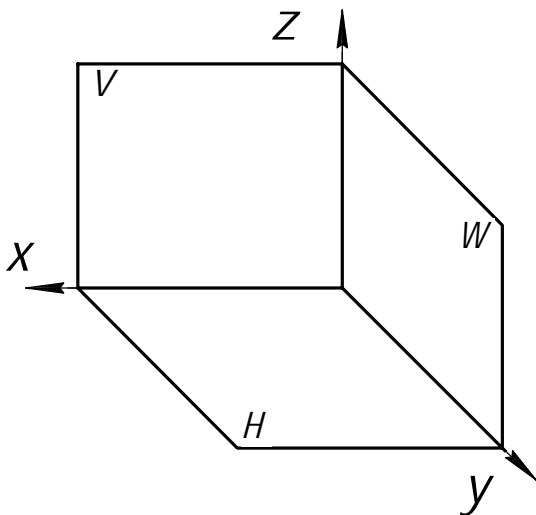

ĭ'āi. è āāā
Ēā. 1 āāē
Āçāi. ēiā. 1
ĭ'āi. è āāā
Ēā. 1 īrāē

Ēçì. Ēēñò	1 āāēōi.	ĭ'āi.	Āāōā
-----------	----------	-------	------

ΓΕΩΜΕΤΡΙΑ

3. Δείξτε ότι οι ευθείες l και m είναι παράλληλες.

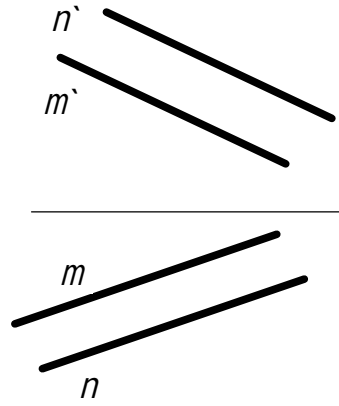
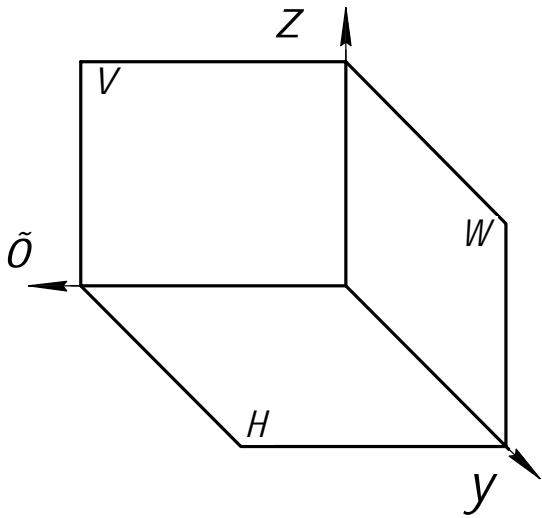

4. Δείξτε ότι οι ευθείες k και l είναι παράλληλες.

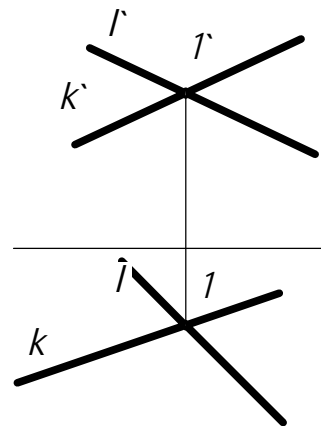
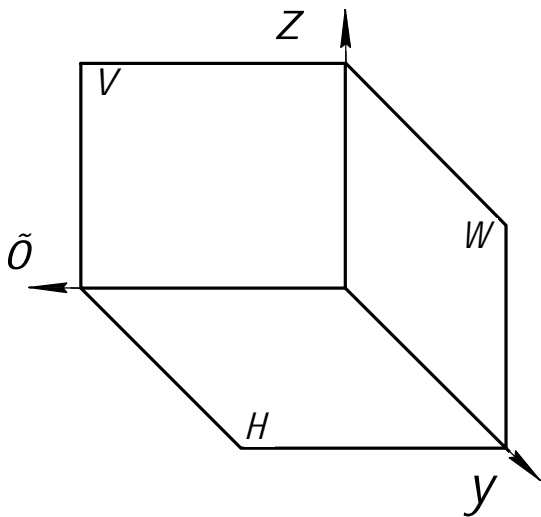

5. Δείξτε ότι οι ευθείες a και a' είναι παράλληλες.

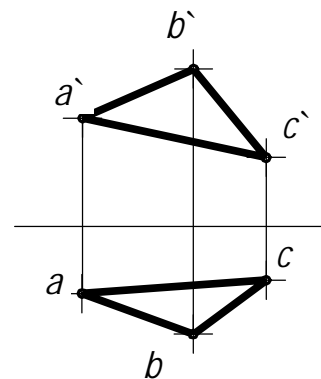
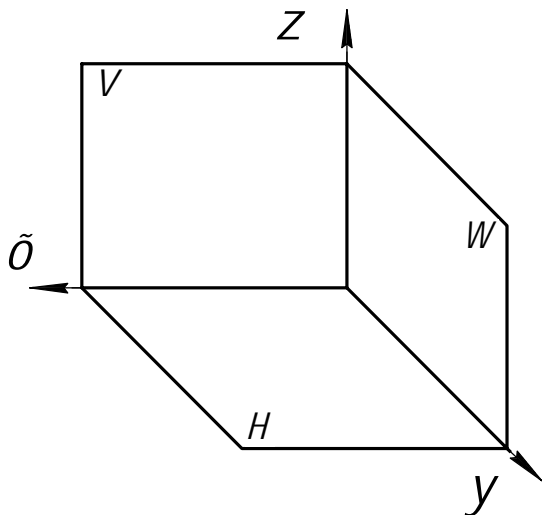

Εία 1	Γράφ.	Γράφ.	Ασκή. εία 1	Εία 1	Ασκή. εία 1	Γράφ.	Γράφ.
Εία 1	Εία 1	Εία 1	Εία 1	Εία 1	Εία 1	Εία 1	Εία 1

Εία 1	Εία 1	Εία 1	Εία 1	Εία 1
Εία 1	Εία 1	Εία 1	Εία 1	Εία 1

ΓΕΩΜΕΤΡΙΑ

Οι άξονες είναι οριζόντιοι -

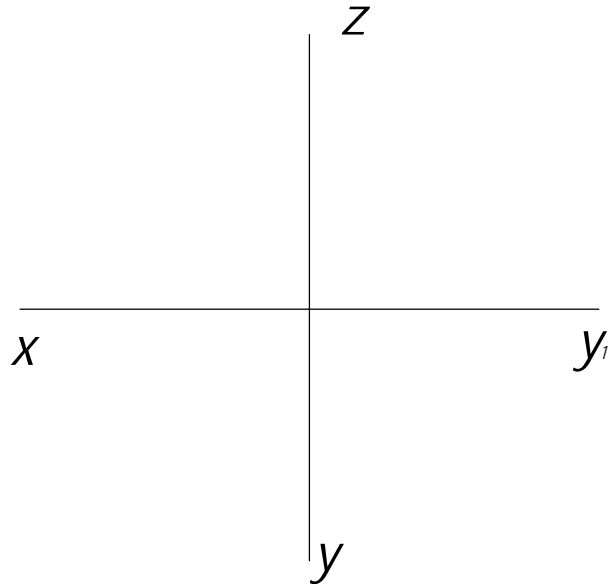
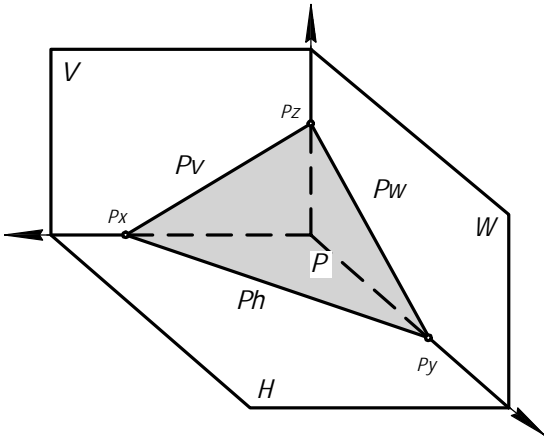

7. Άξονα οριζόντιοι

Άξονα οριζόντιοι είναι οριζόντιοι -

Οι άξονες είναι οριζόντιοι άξονα είναι οριζόντιοι

Άξονα οριζόντιοι είναι οριζόντιοι άξονα οριζόντιοι είναι οριζόντιοι:

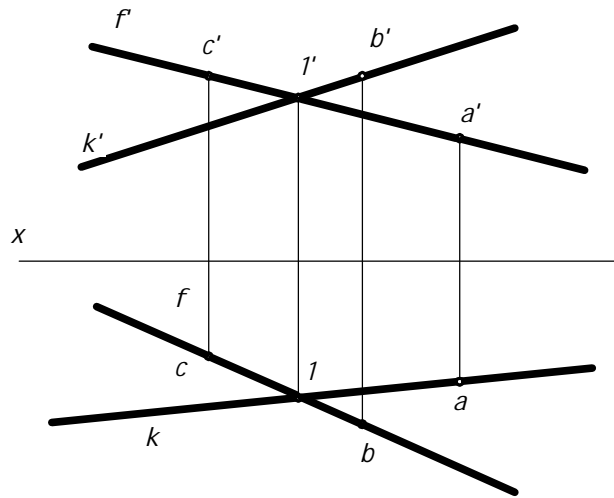
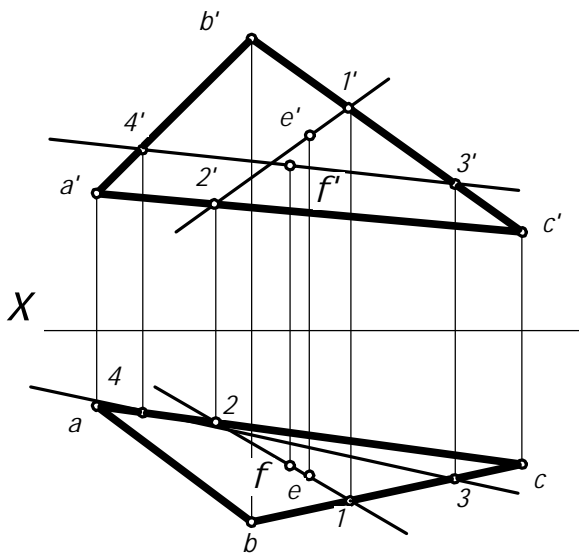

Άξονα οριζόντιοι	Άξονα οριζόντιοι	Άξονα οριζόντιοι	Άξονα οριζόντιοι
Άξονα οριζόντιοι	Άξονα οριζόντιοι	Άξονα οριζόντιοι	Άξονα οριζόντιοι
Άξονα οριζόντιοι	Άξονα οριζόντιοι	Άξονα οριζόντιοι	Άξονα οριζόντιοι
Άξονα οριζόντιοι	Άξονα οριζόντιοι	Άξονα οριζόντιοι	Άξονα οριζόντιοι

Άξονα οριζόντιοι	Άξονα οριζόντιοι	Άξονα οριζόντιοι	Άξονα οριζόντιοι
Άξονα οριζόντιοι	Άξονα οριζόντιοι	Άξονα οριζόντιοι	Άξονα οριζόντιοι

Άξονα οριζόντιοι

Άξονα οριζόντιοι
3

ηου ιεη ιεη ι

*ī ðeçí àê ī ðeí à ä ä ä æ í î ñ ò è
i ðyì î é ê i ë î ñ ê î ñ ò è*

①

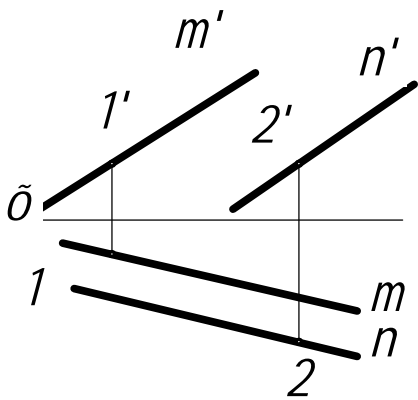

1.

2.

3.

②

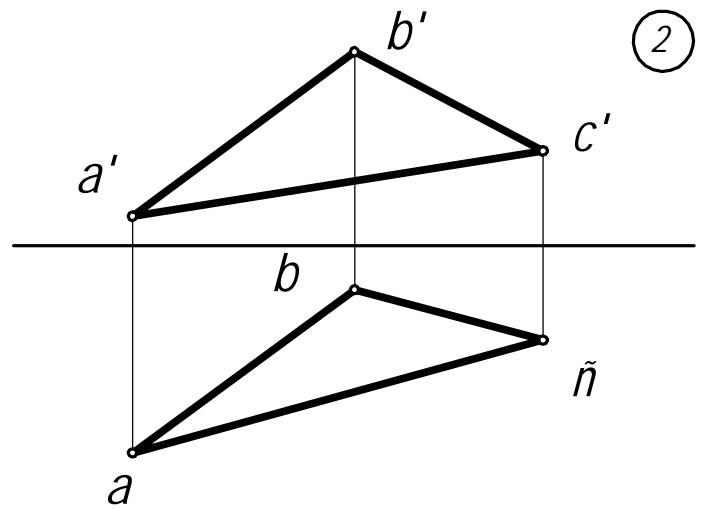

③

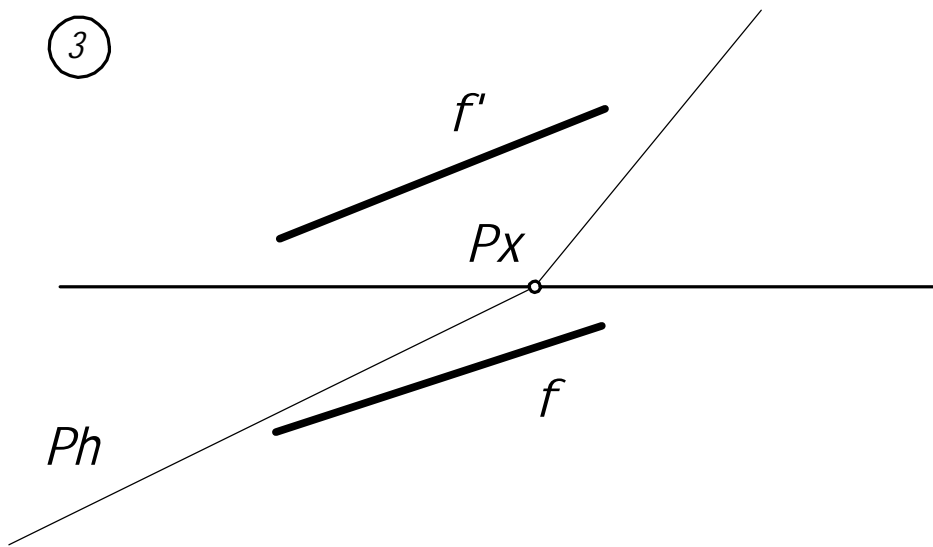

Éíá ¹ iîáè.	Íîáî: è ààòá	Áçáî. è íá. ¹	Éíá. ¹ áòáé.	Íîáî: è ààòá
Éçì. Èèò	¹ áîéòî.	Íîáî.	Áàòá	

ī ë î ñ ê î ñ ò ù

Èèò

4

ηουιουιουι!

*Ãäâíúå èèíèè ìëîñêîñòè
(ìðÿì úå îñîáîáî ìîëîæáíëÿ
â ìëîñêîñòè)*

Ãîðççîíðàëü -

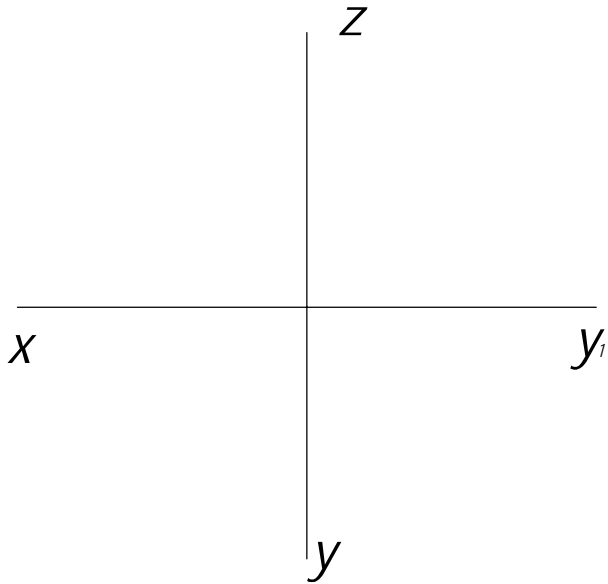
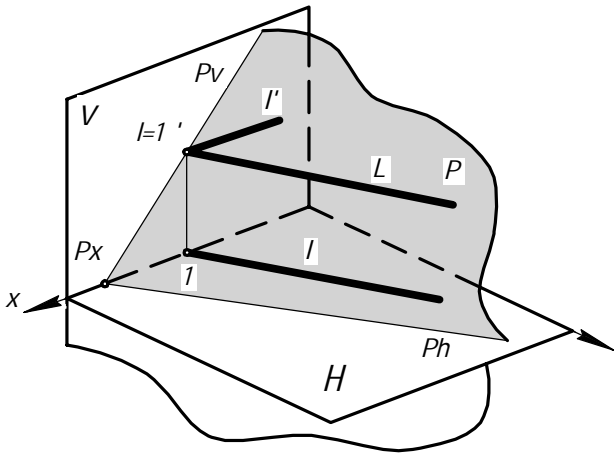

Ôðîíðààëü -

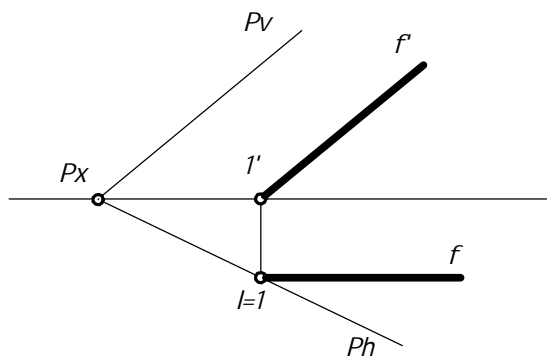
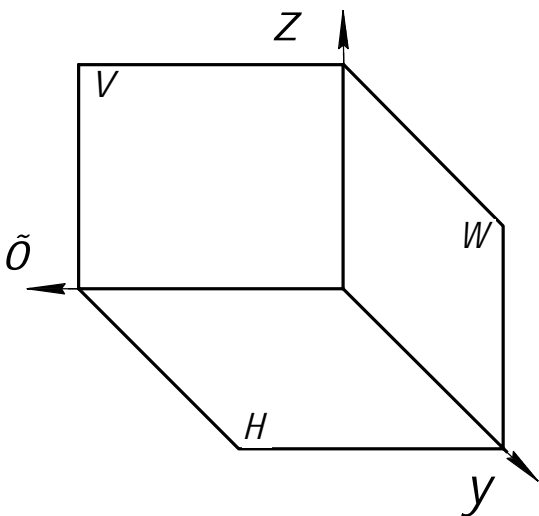

<i>Ìîäî. è äàòà</i>	<i>Èîà. 1 äàòà</i>	<i>Ãçàî. èîà. 1</i>	<i>Ìîäî. è äàòà</i>	<i>Èîà. 1 ìîäî</i>
---------------------	--------------------	---------------------	---------------------	--------------------

<i>Èçì. Èèòò</i>	<i>1 äîèóî.</i>	<i>Ìîäî.</i>	<i>Ãàòà</i>
------------------	-----------------	--------------	-------------

Ìëîñêîñòü

*Èèòò
5*

íèîñèîñòè íðíàèöèè) -

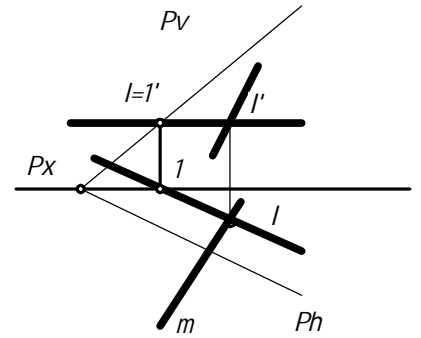
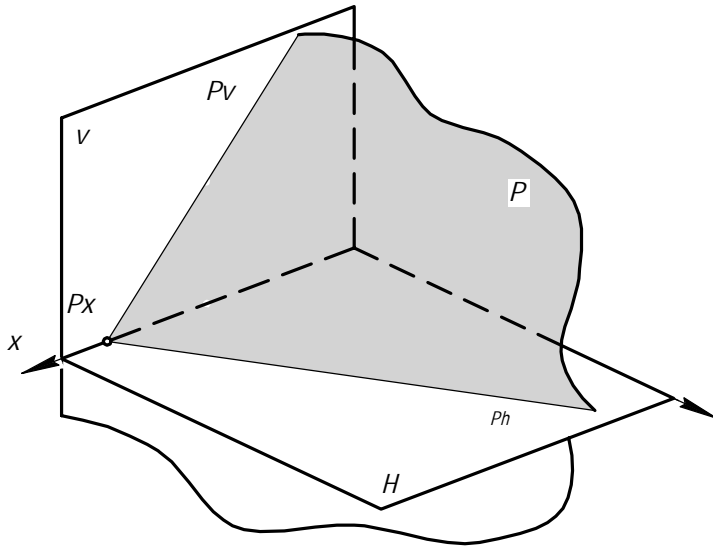

Èèàññèòèèàöèÿ íèîñèîñòàé

<i>Èíá 1 íñáé.</i>	<i>Íñáí. è ààòà</i>	<i>Áçãí. èíá 1</i>	<i>Èíá 1 áòáé.</i>	<i>Íñáí. è ààòà</i>
<i>Èçì. Èèòò</i>	<i>1 áñèòí.</i>	<i>Íñáí.</i>	<i>Áàòà</i>	

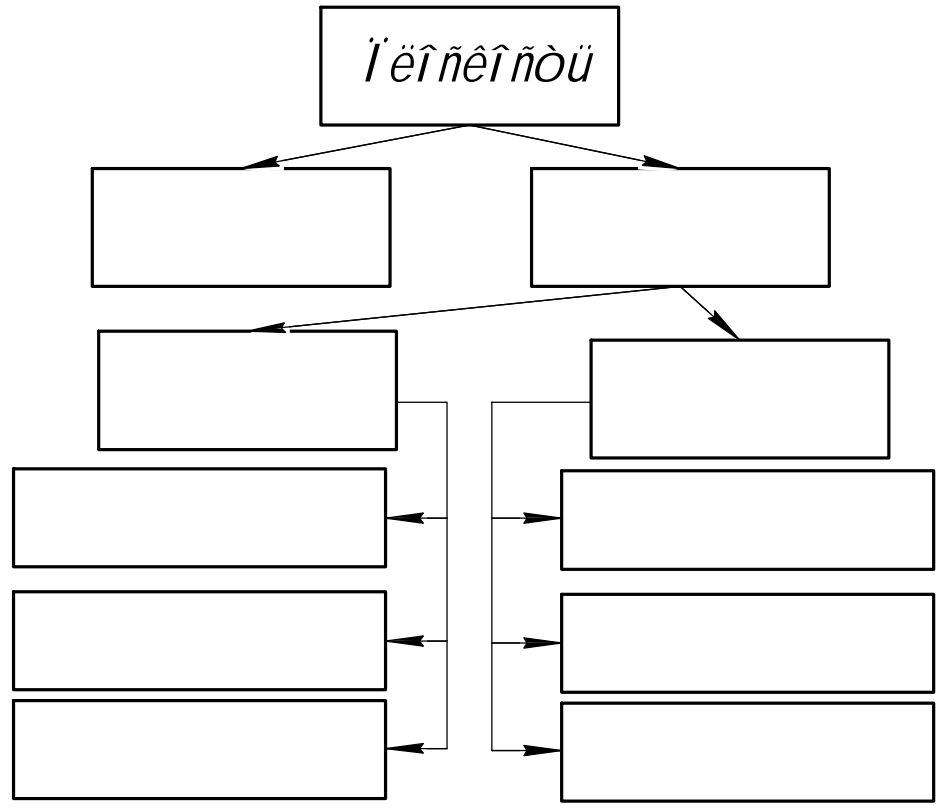

Íèîñèîñòòü

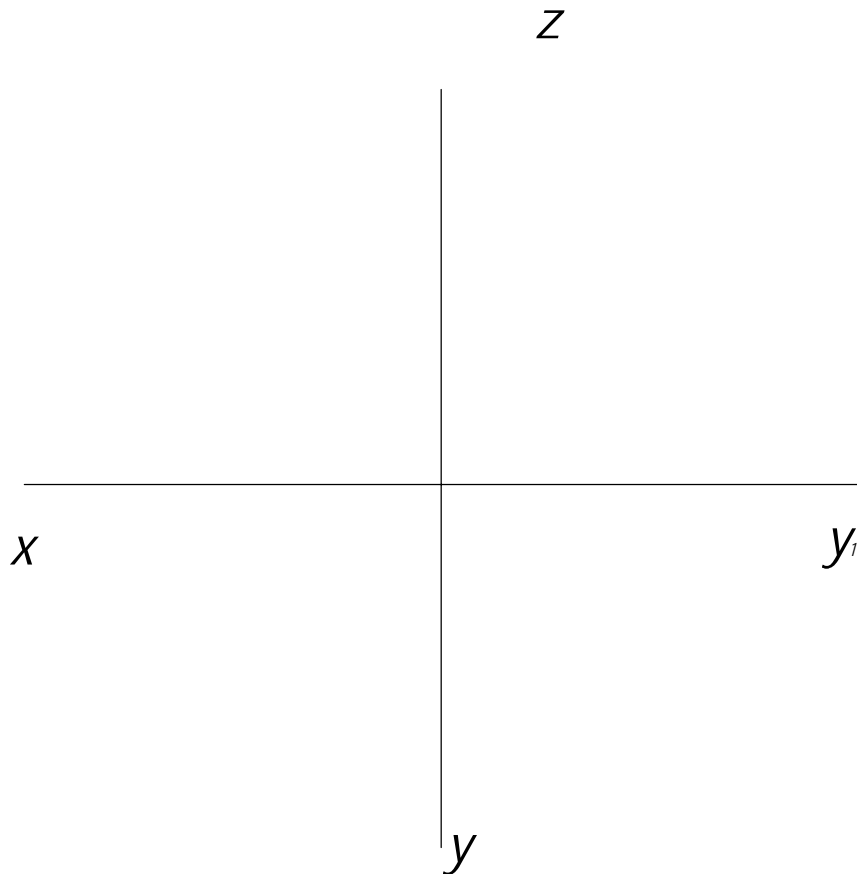
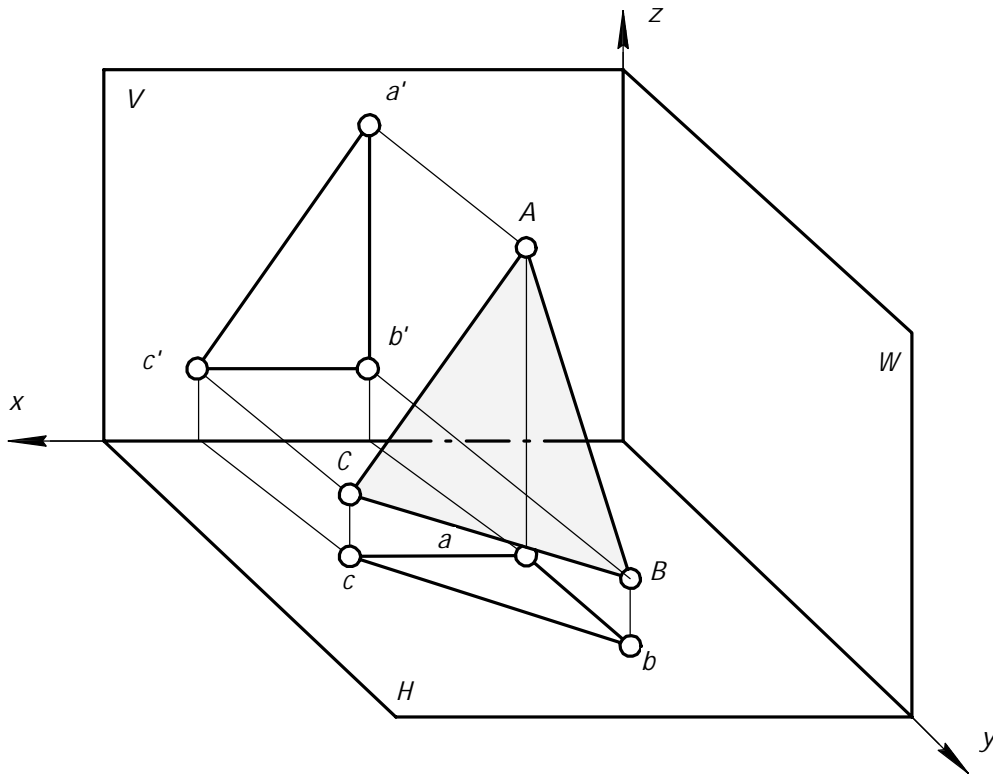

īīāī. è ääöà
Èīā. 1 ääæ
Ācāī. èīā. 1
īīāī. è ääöà
Èīā. 1 īīāè

Ēçì.	Èèñò	1 āīēōī.	īīāī.	Āäöà
------	------	----------	-------	------

īēīñēīñòü

Èèñò
7

īēīñēīñòè óðîāíÿ -

Āîðèçîíîàèüíàÿ īēīñēīñòè óðîāíÿ -

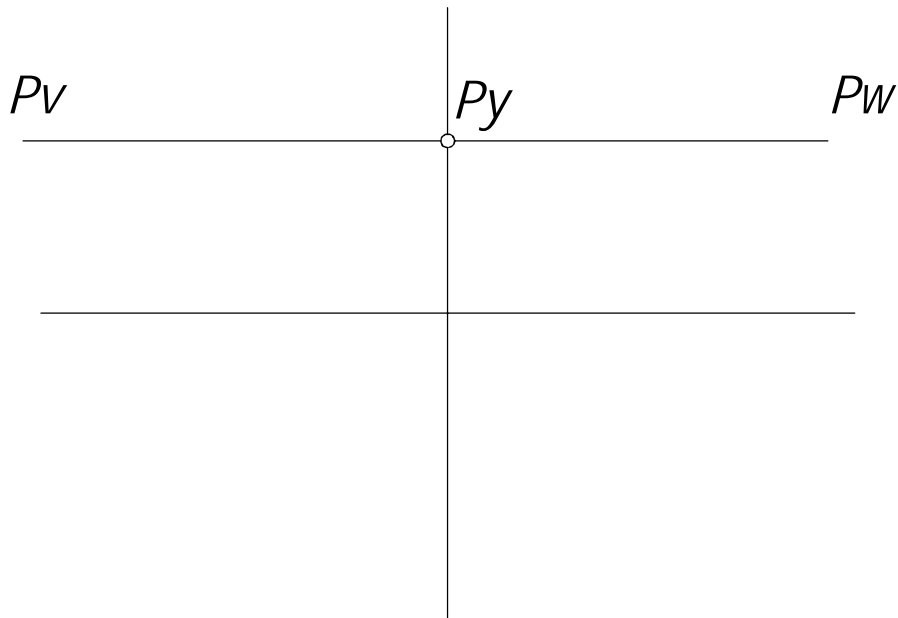
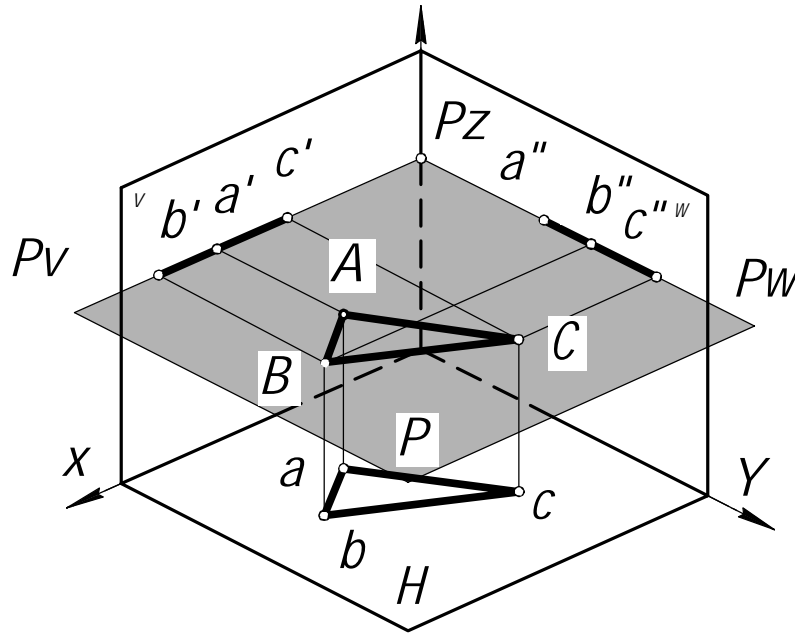

Ñāīēñòāà āîðèçîíîàèüíîē īēīñēīñòè óðîāíÿ

Ēīā 1 īīāē.	Īīāī. è āàòā
Āçāī. èīā 1	Ēīā 1 āòāē.
Īīāī. è āàòā	
Ēīā 1 īīāē.	

Ēçì.	Ēēñò	1 āīēōī.	Īīāī.	Āàòā
------	------	----------	-------	------

īēīñēīñòè

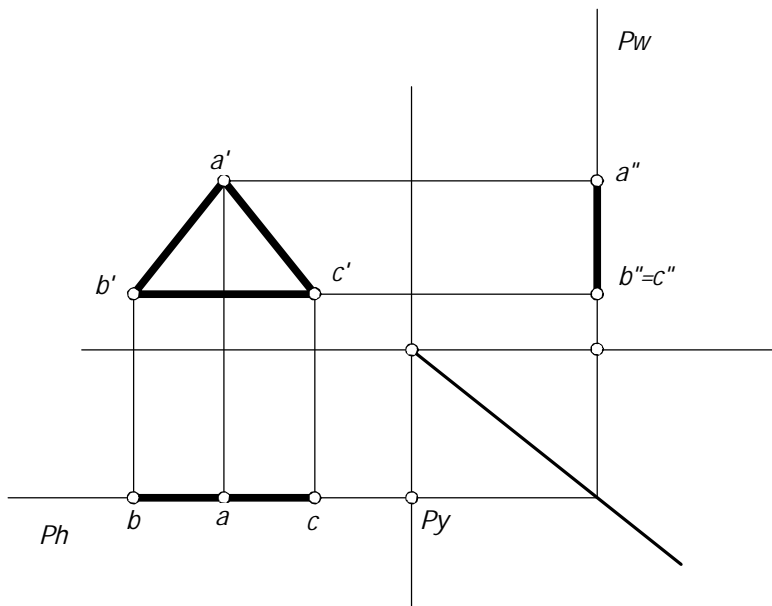
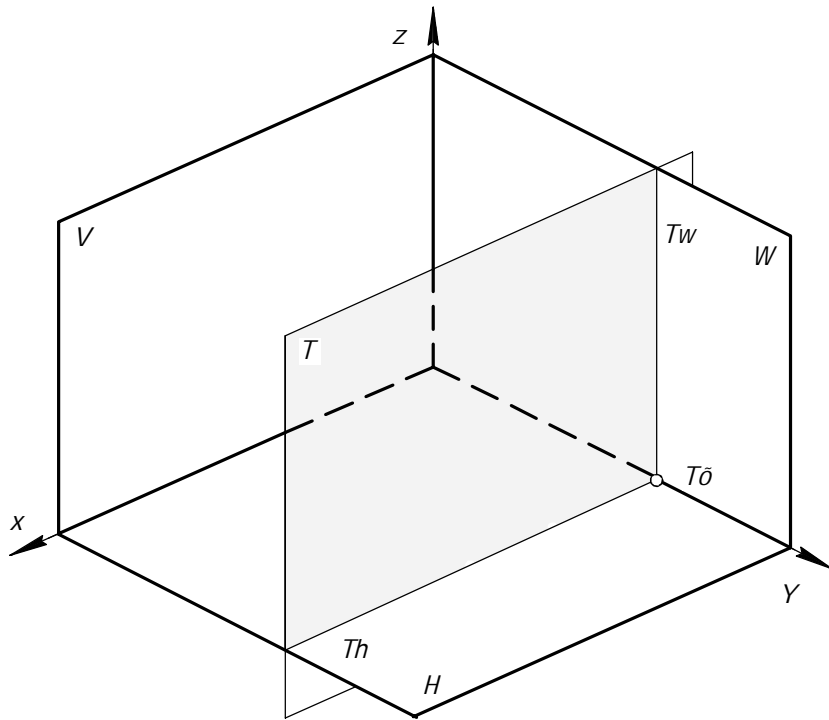

Ἔεϋεñὸαα ὀδί ϱὰεϋίτῆ ἰεῖñεῖñὸϋ ὀδί αίῃ

ἰτῆ: ε̄ ἰαὸα
Ἔεῖ 1 ἰαε̄
Ἄεῖ: εῖτῆ 1
ἰτῆ: ε̄ ἰαὸα
Ἔεῖ 1 ἰτῆ:

Ἔεῖ: Ἔεñὸ	1 ἰαε̄.	ἰτῆ: Ἄεῖ	

ἰεῖñεῖñὸϋ

Ἔεñὸ
9

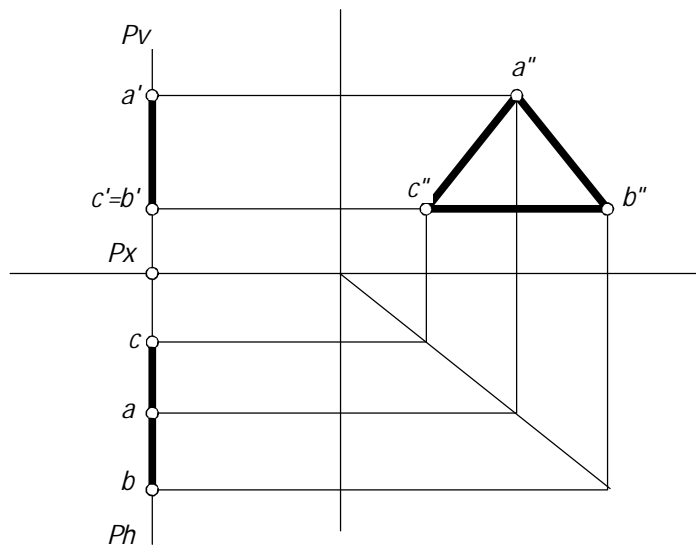
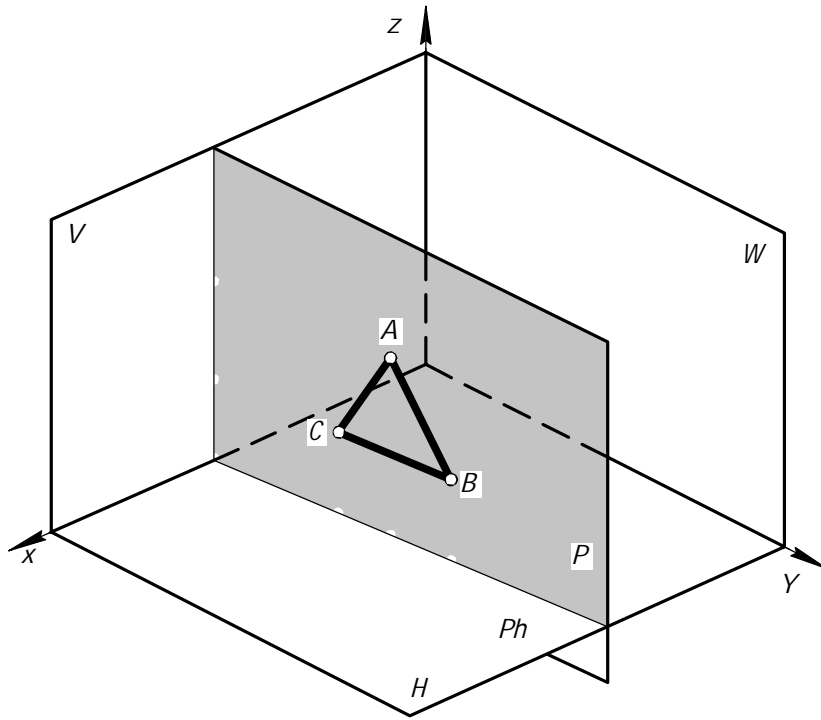

Ñāīēñōāā īđīōēēūīīē īēīñēīñōē ōđīāīy

Ēīā 1 īīāē.	Īīāī. ē āāōā	Īīāī. ē āāōā
Āçāī. ēīā 1	Ēīā. 1 āōāē.	
Ēīā 1 īīāē.		
Ēīā. Ēēñō	1 āīēōī.	Īīāī. Āāōā

Ã̇ĩ̇δ̇ε̇ç̇ĩ̇ ἰ̇ὀ̇ὰ̇ε̇ũ̇ĩ̇ĩ̇ - ἰ̇δ̇ι̇ἀ̇ὀ̇ε̇δ̇ό̇ρ̇υ̇ὰ̇ ἰ̇ε̇ĩ̇ñ̇ε̇ĩ̇ñ̇ὀ̇è

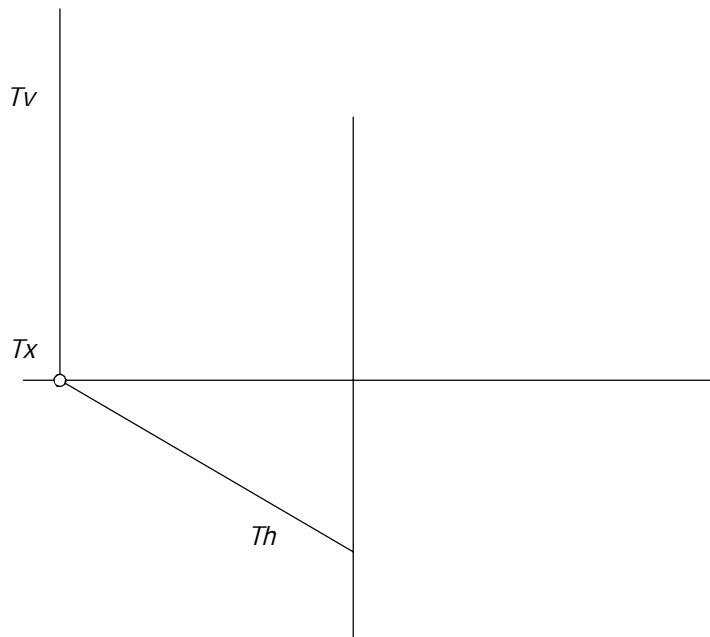
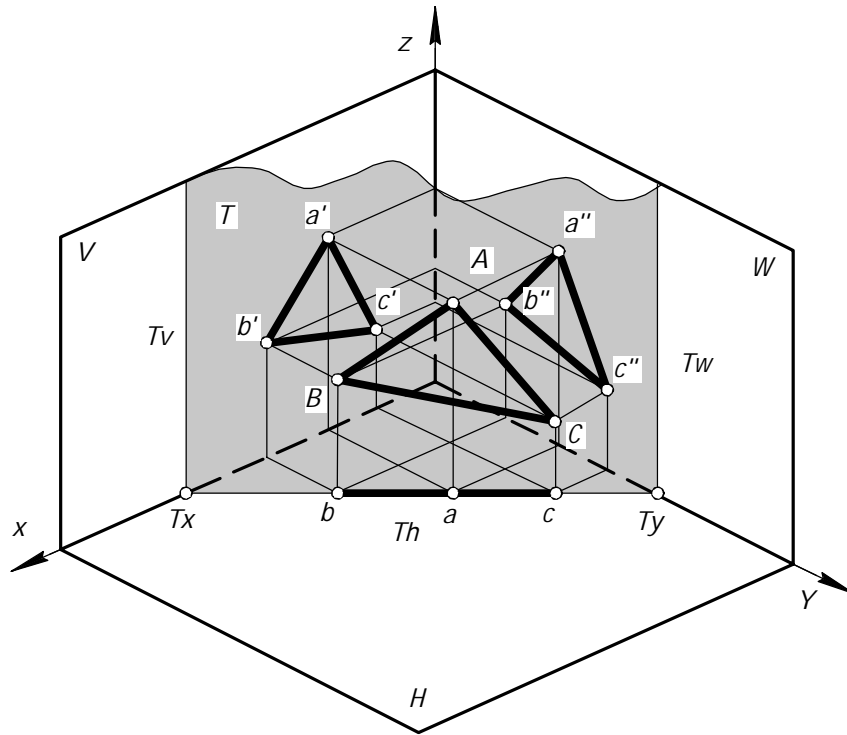

Ñ̇ai̇ε̇ñ̇ὀ̇ὰ̇ ã̇ĩ̇δ̇ε̇ç̇ĩ̇ ἰ̇ὀ̇ὰ̇ε̇ũ̇ĩ̇ĩ̇ ἰ̇δ̇ι̇ἀ̇ὀ̇ε̇δ̇ό̇ρ̇υ̇ὰ̇ε̇ ἰ̇ε̇ĩ̇ñ̇ε̇ĩ̇ñ̇ὀ̇è

Ἰ̇ĩ̇ai̇. ε̇ ã̇ὀ̇ὰ̇
Ἐ̇ĩ̇ã̇. 1 ã̇ὀ̇ὰ̇
Ã̇ç̇ai̇. ε̇ĩ̇ã̇. 1
Ἰ̇ĩ̇ai̇. ε̇ ã̇ὀ̇ὰ̇
Ἐ̇ĩ̇ã̇. 1 Ἰ̇ĩ̇ã̇.

Ἐ̇ç̇i̇.	Ἐ̇ε̇ñ̇ὀ̇	1	ã̇ĩ̇ε̇ὀ̇ĩ̇.	Ἰ̇ĩ̇ai̇.	Ã̇ὰ̇ὀ̇ὰ̇
---------	----------	---	-------------	----------	----------

Ὀδῖ ἰ δὰ εὔῖ ἱ - ἰ δῖ ἄ οὐ δὸ ρ ὑ ἄ ε ἱ εῖνῆῖνῆῖ

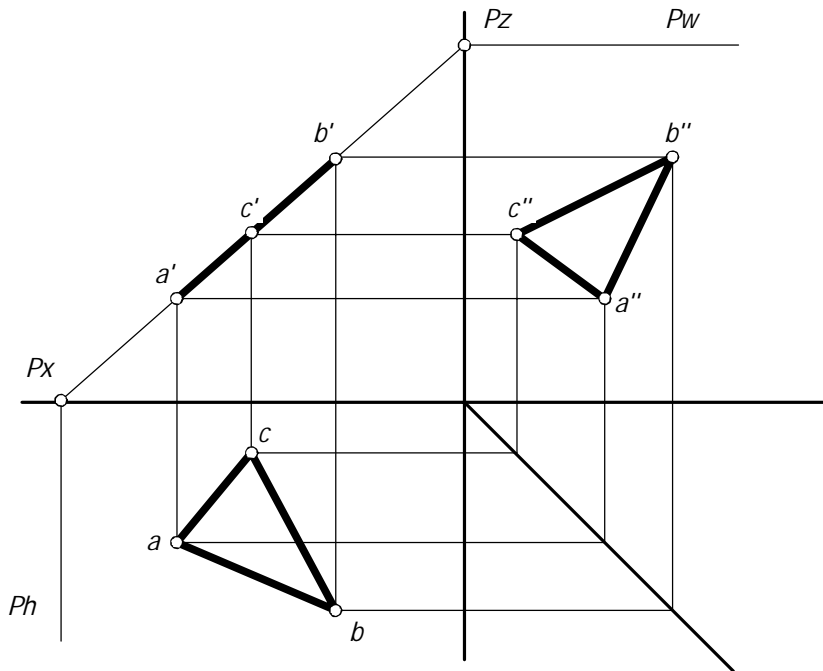
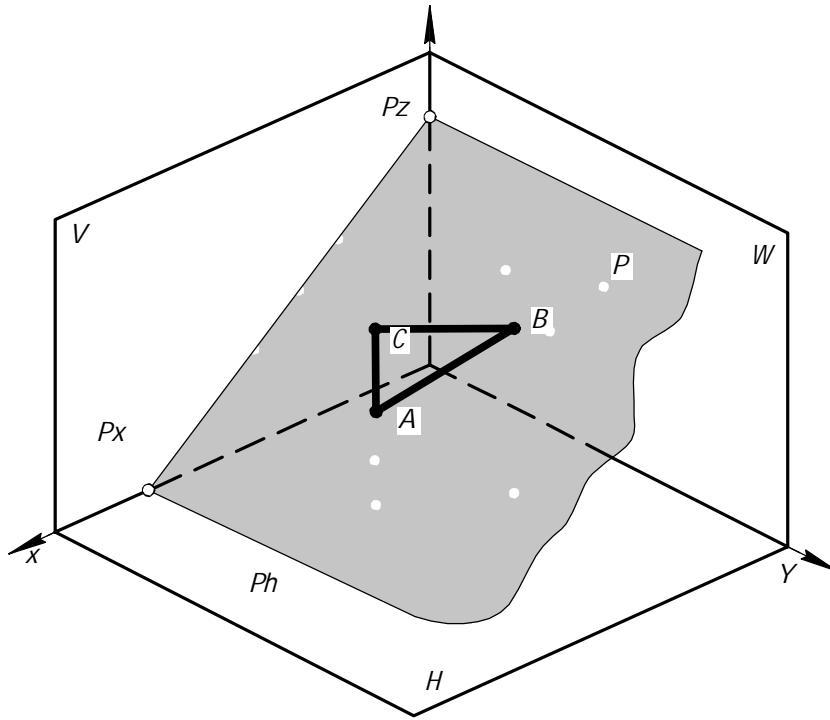

Νᾱῖ εῖνῆῖνῆῖ Ὀδῖ ἰ δὰ εὔῖ ἱ - ἰ δῖ ἄ οὐ δὸ ρ ὑ ἄ ε ἱ εῖνῆῖνῆῖ

Ἰεῖνῆῖνῆῖ	Ἰεῖνῆῖνῆῖ	Ἰεῖνῆῖνῆῖ	Ἰεῖνῆῖνῆῖ	Ἰεῖνῆῖνῆῖ
Ἰεῖνῆῖνῆῖ	Ἰεῖνῆῖνῆῖ	Ἰεῖνῆῖνῆῖ	Ἰεῖνῆῖνῆῖ	Ἰεῖνῆῖνῆῖ
Ἰεῖνῆῖνῆῖ	Ἰεῖνῆῖνῆῖ	Ἰεῖνῆῖνῆῖ	Ἰεῖνῆῖνῆῖ	Ἰεῖνῆῖνῆῖ
Ἰεῖνῆῖνῆῖ	Ἰεῖνῆῖνῆῖ	Ἰεῖνῆῖνῆῖ	Ἰεῖνῆῖνῆῖ	Ἰεῖνῆῖνῆῖ

Ἰεῖνῆῖνῆῖ	Ἰεῖνῆῖνῆῖ	Ἰεῖνῆῖνῆῖ	Ἰεῖνῆῖνῆῖ	Ἰεῖνῆῖνῆῖ
Ἰεῖνῆῖνῆῖ	Ἰεῖνῆῖνῆῖ	Ἰεῖνῆῖνῆῖ	Ἰεῖνῆῖνῆῖ	Ἰεῖνῆῖνῆῖ

ΠΩΣ ΠΩΣ !!

Ίδιόεπιπέδου - Ίδιόεπιπέδου Ίδιόεπιπέδου

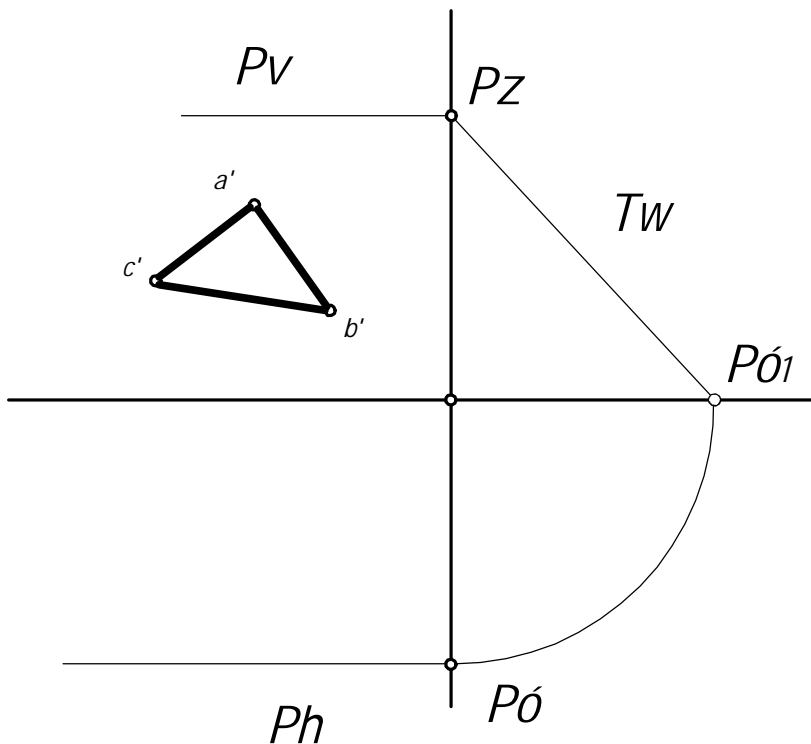
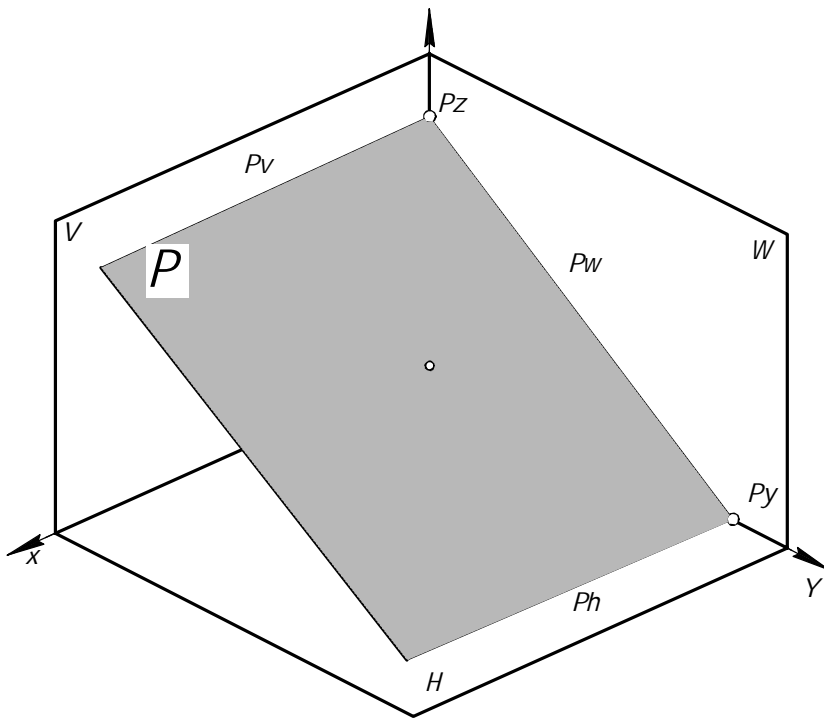

Ναί επιπέδου Ίδιόεπιπέδου - Ίδιόεπιπέδου Ίδιόεπιπέδου

Ίδιόεπιπέδου
Ίδιόεπιπέδου
Ίδιόεπιπέδου
Ίδιόεπιπέδου
Ίδιόεπιπέδου

Εξ.	Εξ	¹ αεί.	Ίδιόεπιπέδου

ηουιθηιη

Ñâî êñòâî ñî áèðàòâëüí îñòè ïðîòòèðòèòè ïèîñêèñòè

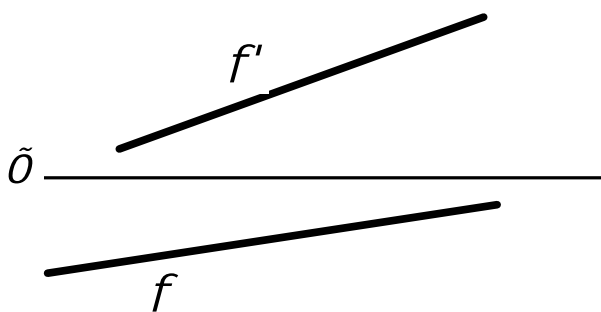

Âçàèì íîá ïîèîæáíèá ïèîñêèñòè

Ïàðàèèâëüí îñòè

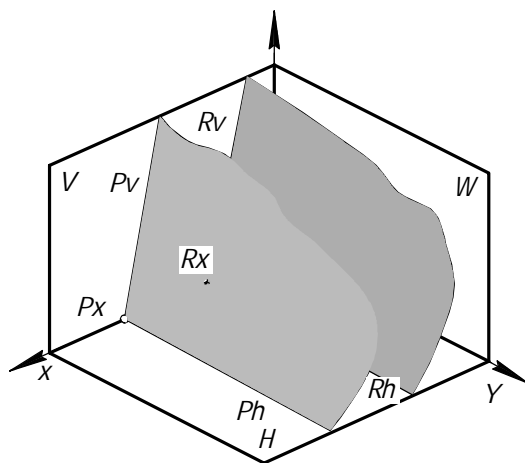

Ïðèçíàè ïàðàèèâëüí îñòè:

1.

2.

ð _____

ð _____

<i>Ëíá îñòè</i>	<i>Ïîñêèñòè</i>	<i>Ëíá îñòè</i>	<i>Ïîñêèñòè</i>
<i>Ëíá îñòè</i>	<i>Ïîñêèñòè</i>	<i>Ëíá îñòè</i>	<i>Ïîñêèñòè</i>
<i>Ëíá îñòè</i>	<i>Ïîñêèñòè</i>	<i>Ëíá îñòè</i>	<i>Ïîñêèñòè</i>
<i>Ëíá îñòè</i>	<i>Ïîñêèñòè</i>	<i>Ëíá îñòè</i>	<i>Ïîñêèñòè</i>

<i>Ëíá îñòè</i>	<i>Ëíá îñòè</i>	<i>Ëíá îñòè</i>	<i>Ëíá îñòè</i>
<i>Ëíá îñòè</i>	<i>Ëíá îñòè</i>	<i>Ëíá îñòè</i>	<i>Ëíá îñòè</i>

Ïèîñêèñòè

$\eta\omicron\upsilon\iota\epsilon\iota\iota$

$\dot{\iota}\grave{\alpha}\delta\grave{\alpha}\grave{\eta}\grave{\alpha}:\acute{\alpha}\acute{\iota}\epsilon\acute{\alpha}\ \dot{\iota}\grave{\epsilon}\hat{\iota}\grave{\eta}\hat{\epsilon}\hat{\iota}\grave{\eta}\grave{\nu}\grave{\omicron}\acute{\alpha}\acute{\epsilon}$

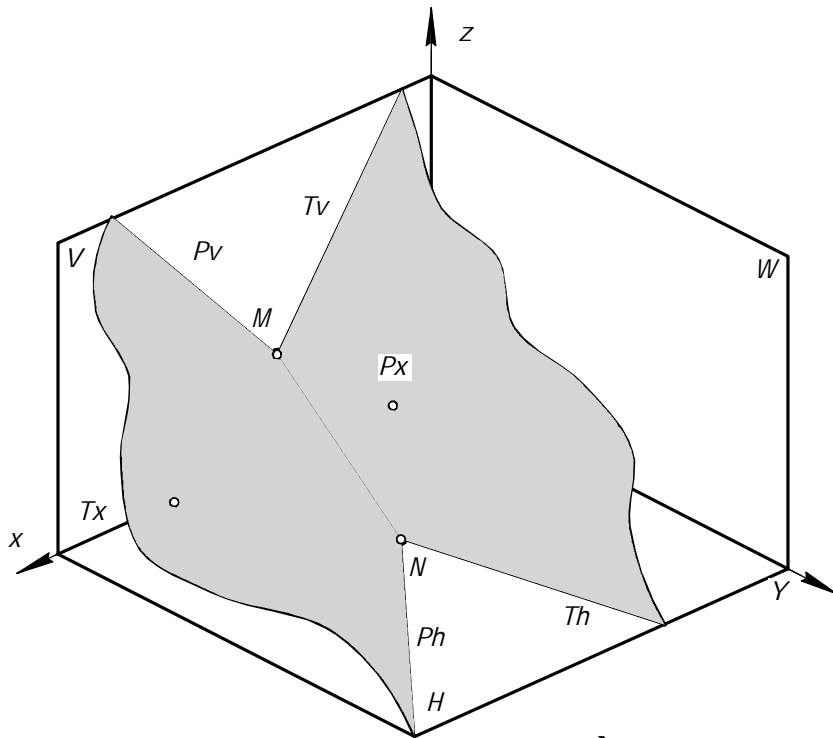

$\grave{\Alpha}\acute{\epsilon}\acute{\alpha}\hat{\iota}\delta\acute{\epsilon}\omicron\grave{\iota}\ \dot{\iota}\hat{\iota}\grave{\eta}\grave{\nu}\delta\hat{\iota}\acute{\alpha}\acute{\iota}\epsilon\grave{\ypsilon}$

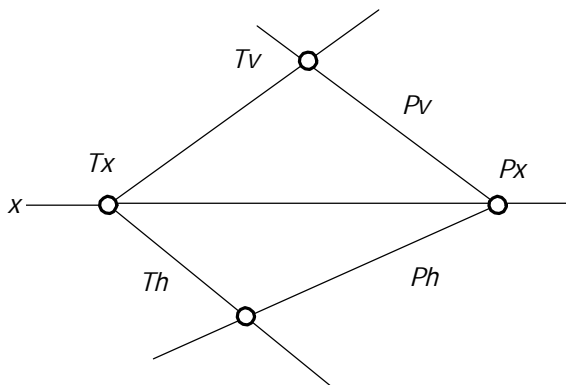

$\dot{\iota}\grave{\alpha}\delta\grave{\alpha}\grave{\eta}\grave{\alpha}:\acute{\alpha}\acute{\iota}\epsilon\acute{\alpha}\ \dot{\iota}\delta\acute{\ypsilon}\hat{\iota}\hat{\iota}\acute{\epsilon}\ \grave{\eta}\ \dot{\iota}\grave{\epsilon}\hat{\iota}\grave{\eta}\hat{\epsilon}\hat{\iota}\grave{\eta}\grave{\nu}\acute{\omicron}\grave{\upsilon}\grave{\rho}$

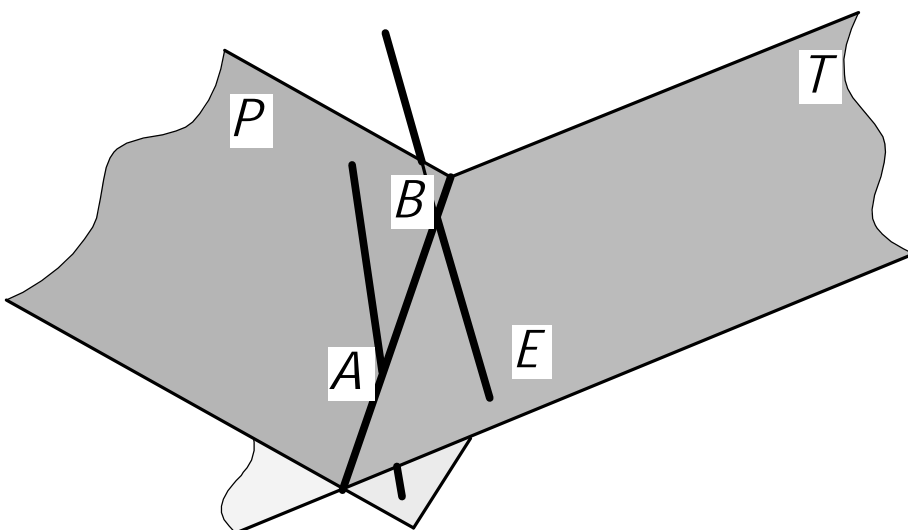

$\dot{\iota}\grave{\epsilon}\hat{\iota}\grave{\eta}\hat{\epsilon}\hat{\iota}\grave{\eta}\grave{\nu}\acute{\omicron}\grave{\ypsilon}$

$\acute{\epsilon}\acute{\epsilon}\grave{\nu}\delta$

15

$\acute{\epsilon}\epsilon\grave{\iota}, \acute{\epsilon}\acute{\epsilon}\grave{\nu}\delta, \acute{\iota}\grave{\alpha}\acute{\iota}\epsilon\acute{\alpha}, \acute{\alpha}\acute{\iota}\epsilon\acute{\alpha}$

$\dot{\iota}\grave{\alpha}\acute{\iota}, \acute{\epsilon}\ \acute{\alpha}\acute{\alpha}\acute{\omicron}\acute{\alpha}$

$\acute{\epsilon}\acute{\iota}\alpha, \acute{\iota}\ \acute{\alpha}\acute{\alpha}\acute{\acute{\epsilon}}$

$\acute{\acute{\alpha}}\acute{\alpha}\hat{\iota}, \acute{\epsilon}\hat{\iota}\alpha, \acute{\iota}$

$\dot{\iota}\grave{\alpha}\acute{\iota}, \acute{\epsilon}\ \acute{\alpha}\acute{\alpha}\acute{\omicron}\acute{\alpha}$

$\acute{\epsilon}\acute{\iota}\alpha, \acute{\iota}\ \dot{\iota}\grave{\alpha}\acute{\acute{\epsilon}}$

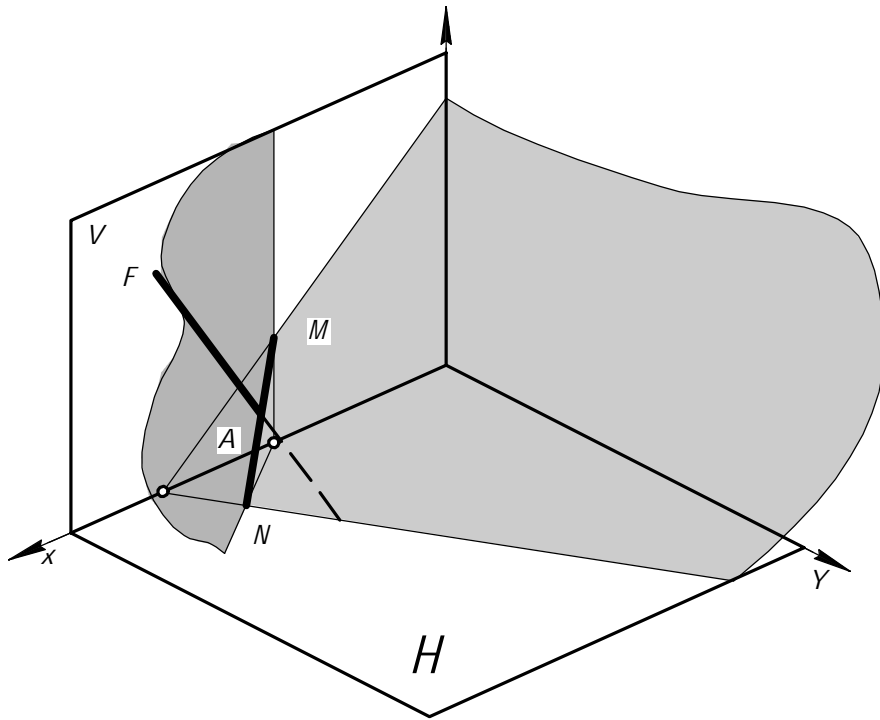

Ἀεῖνῆῖνῆῖν ἰῖνῆῖνῆῖν ὀῖνῆῖν ἰῖνῆῖνῆῖν ἰῖνῆῖνῆῖν ἰῖνῆῖνῆῖν ἰῖνῆῖνῆῖν ἰῖνῆῖνῆῖν

- 1.
- 2.
- 3.

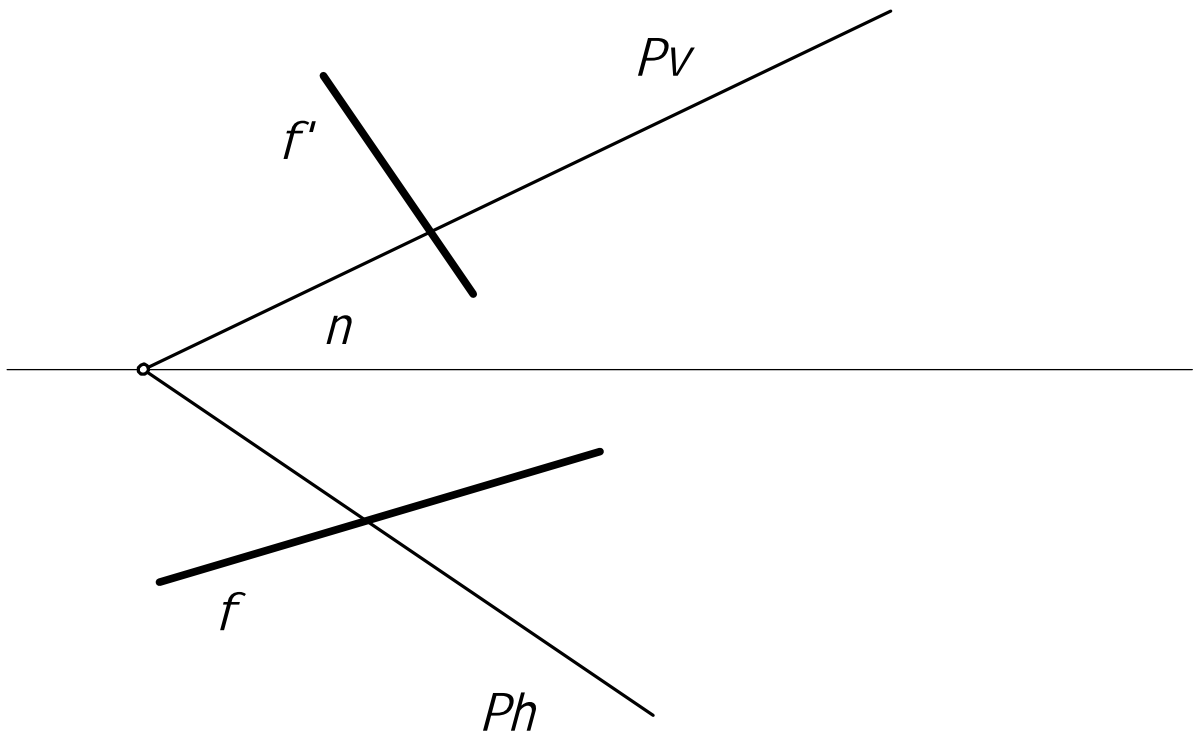

Ἰεῖνῆῖνῆῖν	ἰῖνῆῖνῆῖν	ἰῖνῆῖνῆῖν	ἰῖνῆῖνῆῖν	ἰῖνῆῖνῆῖν
ἰῖνῆῖνῆῖν	ἰῖνῆῖνῆῖν	ἰῖνῆῖνῆῖν	ἰῖνῆῖνῆῖν	ἰῖνῆῖνῆῖν
ἰῖνῆῖνῆῖν	ἰῖνῆῖνῆῖν	ἰῖνῆῖνῆῖν	ἰῖνῆῖνῆῖν	ἰῖνῆῖνῆῖν
ἰῖνῆῖνῆῖν	ἰῖνῆῖνῆῖν	ἰῖνῆῖνῆῖν	ἰῖνῆῖνῆῖν	ἰῖνῆῖνῆῖν

ἰῖνῆῖνῆῖν	ἰῖνῆῖνῆῖν	ἰῖνῆῖνῆῖν	ἰῖνῆῖνῆῖν	ἰῖνῆῖνῆῖν
ἰῖνῆῖνῆῖν	ἰῖνῆῖνῆῖν	ἰῖνῆῖνῆῖν	ἰῖνῆῖνῆῖν	ἰῖνῆῖνῆῖν

Ἰεῖνῆῖνῆῖν

İđyî àÿ, îàðàëëãëüí àÿ çàãàíîé îëîñêîñðè

İðèçíàè îđyî îé îàðàëëãëüíîé îëîñêîñðè:

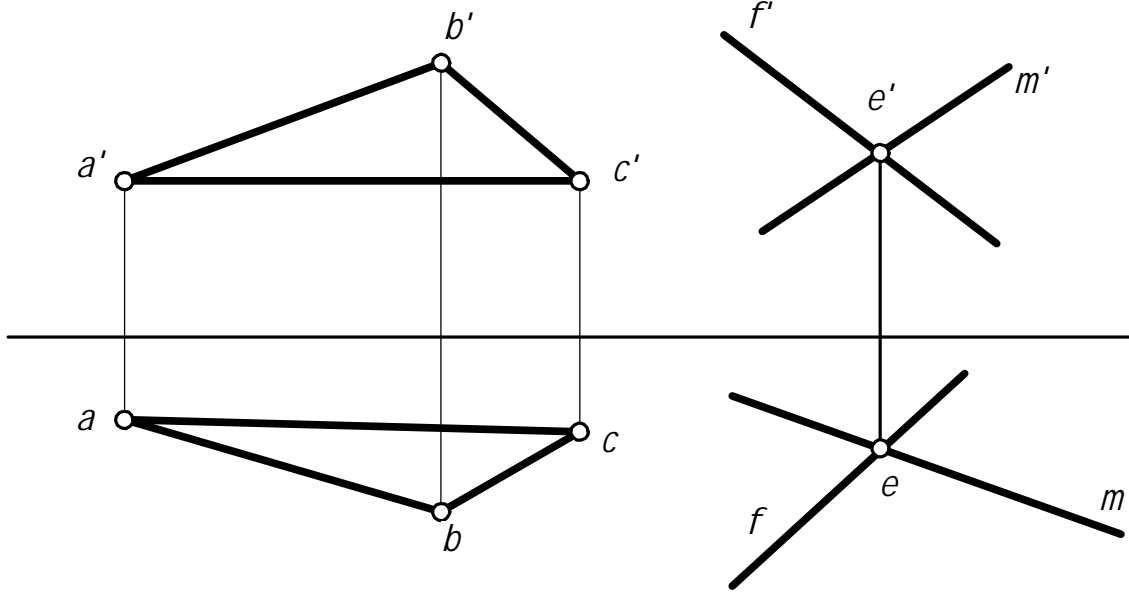

Éíá ¹ îîãé.	İîãî. è ààðà	Áçãî. èíá ¹	Éíá ¹ áðáé.	İîãî. è ààðà
Éçì.	Èëò	¹ áñéòî.	İîãî.	Áàðà

âûîîëíáíèå èíäèâèäóàèüíîãî çääáíèý

Çääáíèå

A(60,60,10)

B(45,15,65)

C(0,5,25)

S(10,45,55)

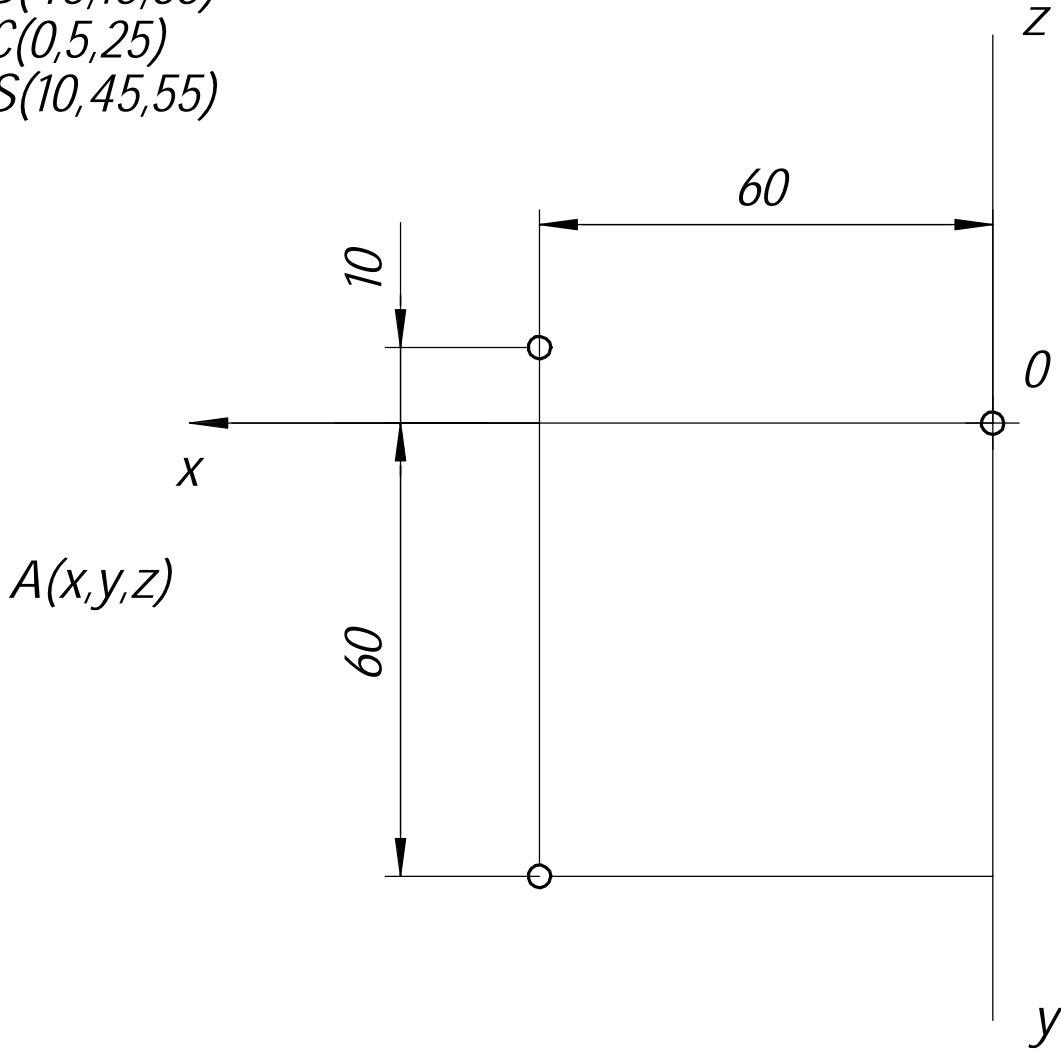

Çääà÷à 1 - Ìîñðîíèòü ñèääü ïèîñèîñèè çääáíîé òðáóáîèüíèèîî ABC

- 1.
- 2.
- 3.

Ìîí. è äàòà
Èíà 1 äàè
Áçàí. èíà 1
Ìîí. è äàòà
Èíà 1 ïñè

Èçì.	Èèò	1 äíèóí.	Ìîí.	Äàòà
------	-----	----------	------	------

4.

5.

Εἷα 1 ἱῖαέ.	Ἰῖαι. ἐ ἀὰα	Ἀὰἰ. ἐῖα 1	Εἷα 1 ἀὰέ.	Ἰῖαι. ἐ ἀὰα	<p style="text-align: center;"> \bar{o} ←————— 0 </p>	<p style="text-align: center;"> <i>Υἱὸς 11</i> </p>	Εἷαὸ
Εἷα 1 ἱῖαέ.	Ἰῖαι. ἐ ἀὰα	Ἀὰἰ. ἐῖα 1	Εἷα 1 ἀὰέ.	Ἰῖαι. ἐ ἀὰα			2
Εἷα 1 ἱῖαέ.	Ἰῖαι. ἐ ἀὰα	Ἀὰἰ. ἐῖα 1	Εἷα 1 ἀὰέ.	Ἰῖαι. ἐ ἀὰα			

Çääà÷à 2 - Îiđääääèèòü ðàññòîÿíèà îò òî÷èè Ñ äî
îëîñêîñè òðáóâîëüíèèà ÀÃÑ



1.

2.

Ïäî. è äàòà
Ëîà. 1 äàè
Ãçäî. èîà. 1
Ïäî. è äàòà
Ëîà. 1 ÿäè

Ëçì.	Ëèò	1 äîèóî.	Ïäî.	Ãàòà
------	-----	----------	------	------

3.

4.

5.

6.

7.

8.

9.

10.

11.

12.

13.

14.

Éia 1 iīāē.	Īīāi. ē āāōā	Āāī. ēīā. 1	Éīā. 1 āāē.	Īīāi. ē āāōā
Éī.	Ēēō	1 āēōī.	Īīāi.	Āāōā

Γὰρ ὁ ἀριθμὸς 20 ἰσὺς ἐστὶν τοῦ ἑξήκοντος ὁμοειδήσῳ ἐστὶν ἡ
ἰσοπέδου ἑξήκοντος 0 ἰσοπέδου ἑξήκοντος
ὁμοειδήσῳ ἐστὶν, ἡ ἑξήκοντος ἰσοπέδου ἐστὶν



Ἰταί. ἐ ἀαὸα
Ἐἰά. 1 ἀαἰ
Ἀαἰ. εἰά. 1
Ἰταί. ἐ ἀαὸα
Ἐἰά. 1 ἰταἰ

Ἐἰ.	Ἐἰῶ	1 ἀἰεῶ.	Ἰταί.	Ἀαὸα
-----	-----	---------	-------	------

1.

2.

3.

4.

5.

6.

7.

8.

9.

10.

11.

12.

×āđāç òî ÷ êó Ñ iđîâñòè i'ēîñēîñòü R
i'āđî'āí'āèèóëyđí'óp ñòîđîí'á'ĀĀ

1.

2.

3.

Éíá 1 i'īāē.	Íīāi. è āàòā	Āçāī. è íá. 1	Éíá. 1 āāē.	Íīāi. è āàòā
--------------	--------------	---------------	-------------	--------------

Éçì.	Èēñò	1 āīēōī.	Íīāi.	Āàòā	Yipō 11	Èēñò
						6

Yipō 1 1

×ãđãç òî÷êó Ñ îđîâñòè iëîñêîñòü R
iãđîáíäèéóëýđíóp ñòîđîíá ÄÄ

0



0

Íîî. è äàòà
Èíà. 1 äàè.
Äçîî. èíà. 1
Íîî. è äàòà
Èíà. 1 ííäè.

Èçì.	Èèò	1 äîéóì.	Íîî.	Äàòà
------	-----	----------	------	------

Yipō 1 1

Èèò
5

Ñi'îñîáú i'đáîáđàçîâáíèÿ ÷áđòáæà

1. Çàää÷è i'îçèöèííúâ-

2. Çàää÷è ì áòðè÷ãñèèá -

Í àèáíèää áúãíáíâ ÷ãñòíâ i'îëîæáíèèã ããî ì áòðè÷ãñèèá ã
î áúáèòà ñ÷èòááòñÿ:

Äëÿ ÿòîãî:

1.

2.

Éíá ¹ i'îáé.	Íîáî. è áàòá	Áçãî. èíá. ¹	Éíá. ¹ áòáé.	Íîáî. è áàòá
Éçî.	Èèòò	¹ áíèòî.	Íîáî.	Áàòá

Ἰταῖ. ἔ ἀαὸα Ἐῖα. 1 ἀαἶ Ἀαῖ. εῖα. 1 Ἰταῖ. ἔ ἀαὸα Ἐῖα. 1 Ἰταῖ.

Ἰταῖ. ἔ ἀαὸα Ἐῖα. 1 ἀαἶ Ἀαῖ. εῖα. 1 Ἰταῖ. ἔ ἀαὸα Ἐῖα. 1 Ἰταῖ.

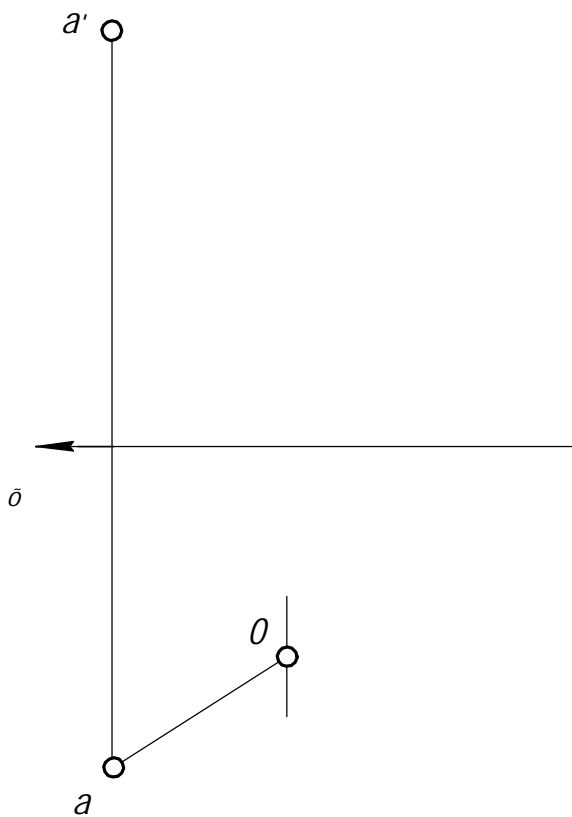
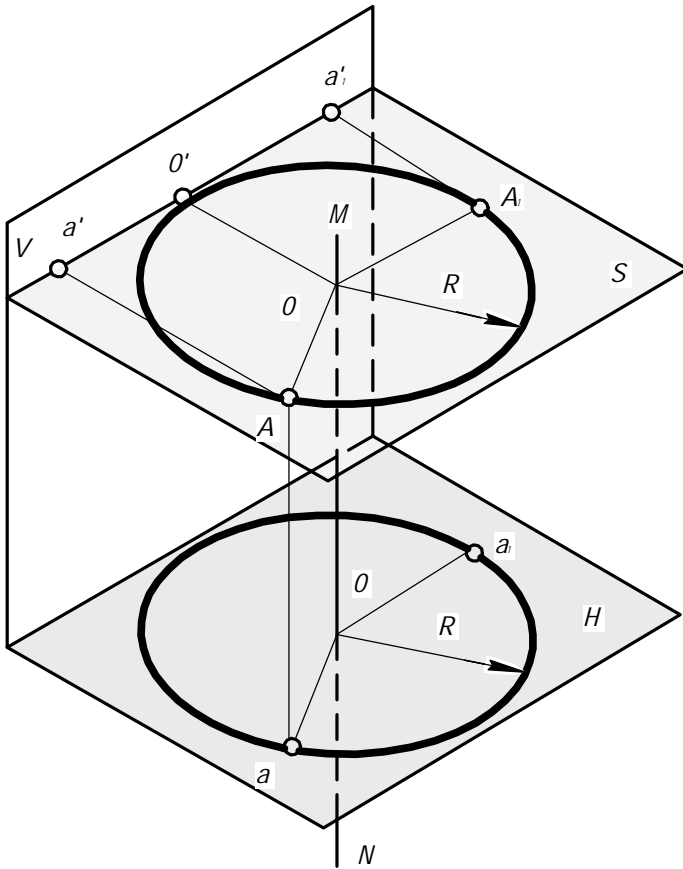

Ἰταῖ. ἔ ἀαὸα	Ἐῖα. 1 ἀαἶ	Ἀαῖ. εῖα. 1	Ἰταῖ. ἔ ἀαὸα	Ἐῖα. 1 Ἰταῖ.
--------------	------------	-------------	--------------	--------------

Ἐῖα.	Ἐῖα. 1	Ἰταῖ.	Ἀαῖ.
------	--------	-------	------

Ἰταῖ. ἔ ἀαὸα Ἐῖα. 1 ἀαἶ Ἀαῖ. εῖα. 1 Ἰταῖ. ἔ ἀαὸα Ἐῖα. 1 Ἰταῖ.

Ἐῖα. 2

Ἐπίπεδα ἴσως ἢ ἀεὶ ἄλληλα ἴση
 ἰσοπέδησι τῶν ἐπιπέδων ἰσοπέδησι

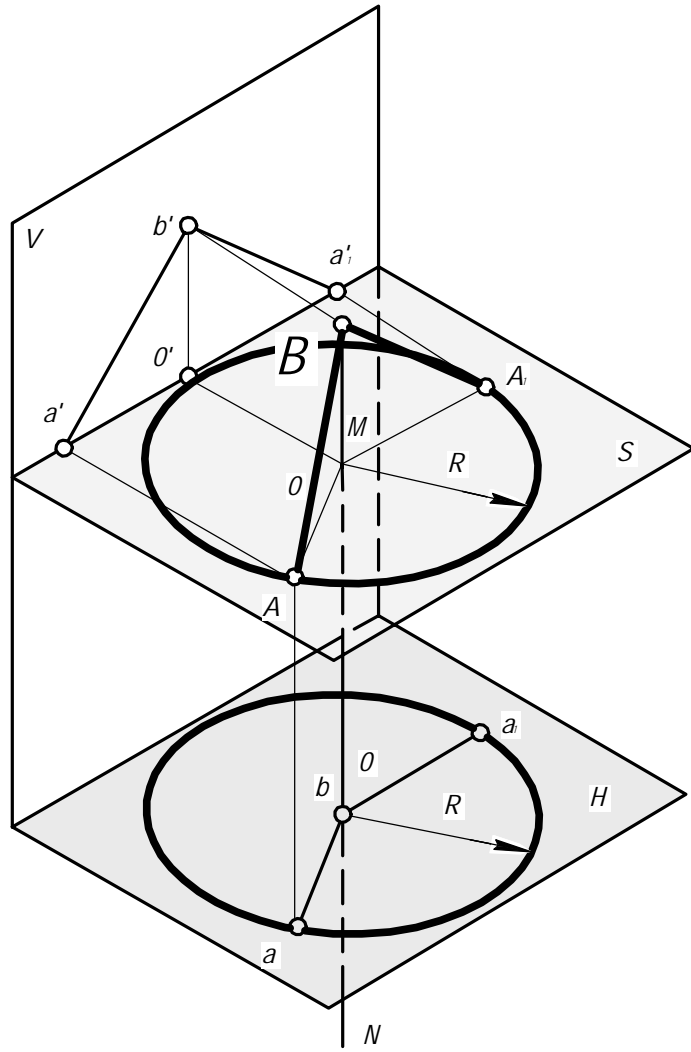

ο ←

Εἶα ἰ ἴαε.	ἴῖαι. ε̂ ἀαα	Ἀαῖ. εἶα ἰ	Εἶα ἰ ἀαε.	ἴῖαι. ε̂ ἀαα
------------	--------------	------------	------------	--------------

Νίη νή άύή ί δάή άδ άçή άάή έϋ ÷ άδδ άæά

Άδδ άή έά ή δϋή ή έ άή έδδ ά ή ñέ
 ή άδ ή άή άέέ έόέ δ ή έ ή έ ή ñέ ή ñδέ ή δ ή άέέ έέ

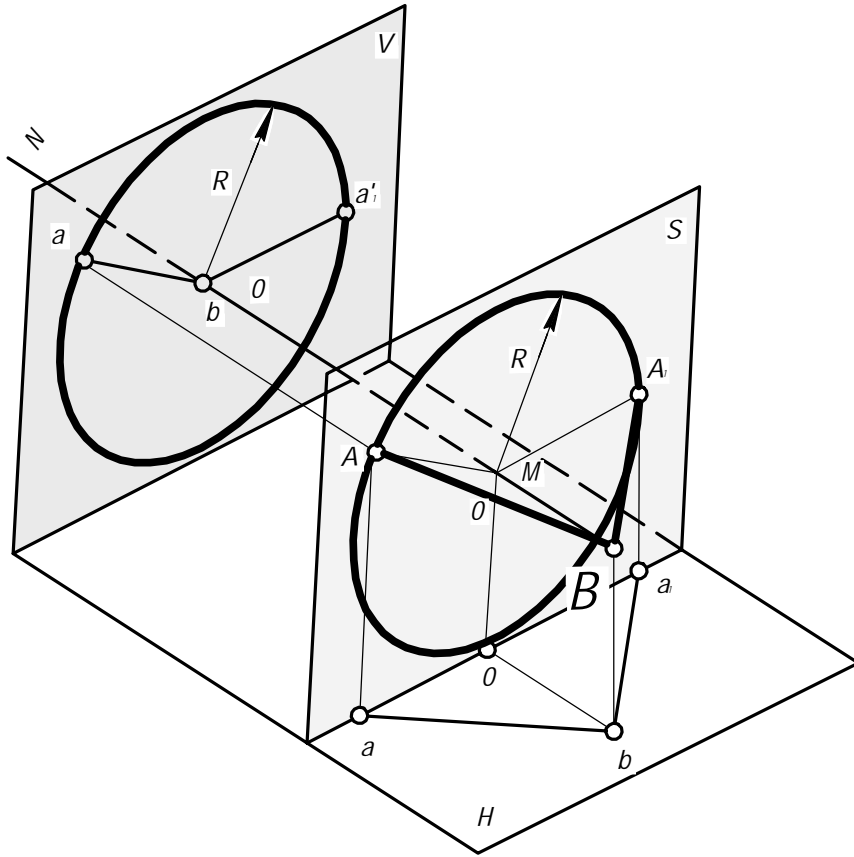

← δ

ή ήή έ άάά	Έήά 1 άάέ	Άçήή. έήά. 1	ή ήή έ άάά	Έήά 1 ή ήέ
------------	-----------	--------------	------------	------------

Έçì. Έέñδ	1 άήέόì.	ή ήή.	Άάδδ	Νή ή ñή άύή ή δάή άδ άçή άάή έϋ ÷ άδδ άæά	Έέñδ 4
-----------	----------	-------	------	---	-----------

Αδὰὐαίεα̃ ἀἱέδοᾶ ἱñè ἰὰδᾶεῖᾶεῦἱἱέ ἰεἱñèἱñòè ἰδῖᾶεῖῖ

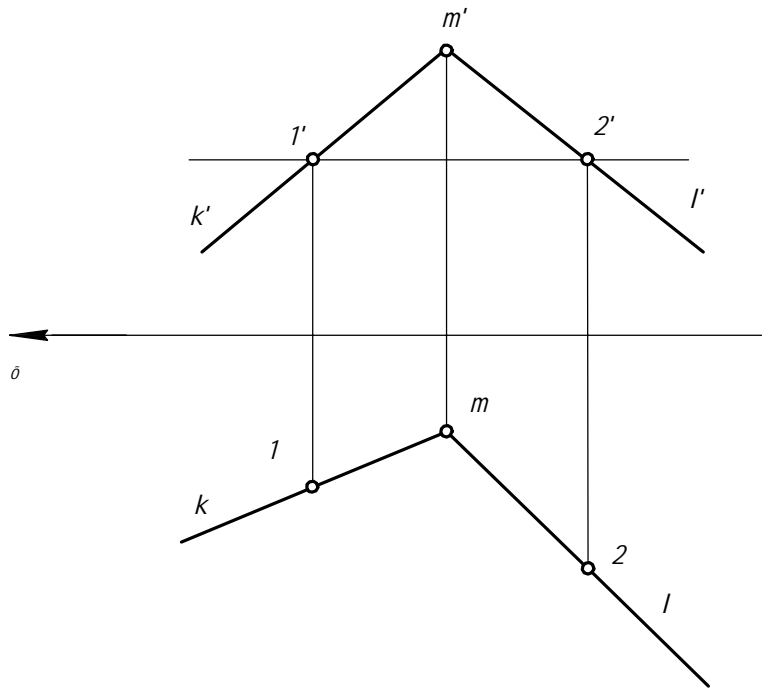

Κἰἱñἱά ἰεἱñèἱἰὰδᾶεῖᾶεῦἱἱἱἱἱ ἰᾶδᾶἱ ᾶὐαίεῖῖ

Νόὐἱἱñòῦ ñἱἱñἱάᾶ

Εἱᾶ ἱ ἱἱᾶε.	ἱἱᾶἱ. ἱ ᾶᾶᾶ	Ἀῗᾶἱ. ἱᾶ. ἱ	Εἱᾶ. ἱ ᾶᾶᾶ.	ἱἱᾶἱ. ἱ ᾶᾶᾶ
Ἐῗἱ. Ἐεἱò	ἱ ᾶἱεῖῖ.	ἱἱᾶἱ.	Ἀᾶᾶ	

Νίϊ η̄ η̄ αὺ ἰ δ᾿ ἰ ἀ δ᾿ ἀ ῥ ἰ ἀ ἰ ἔ ῦ ÷ ἀ δ ᾿ ᾶ ᾱ

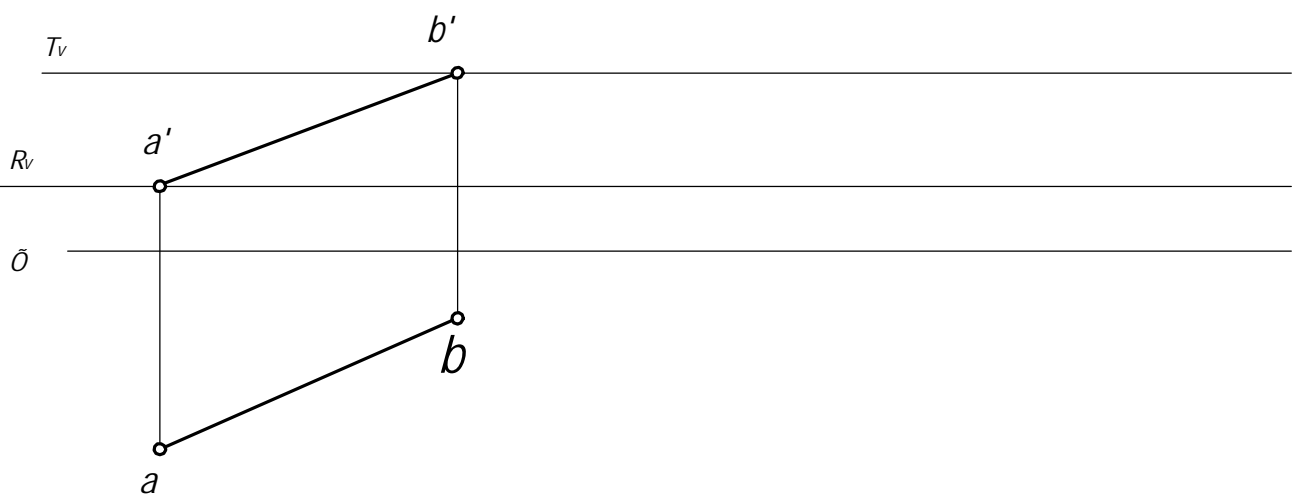
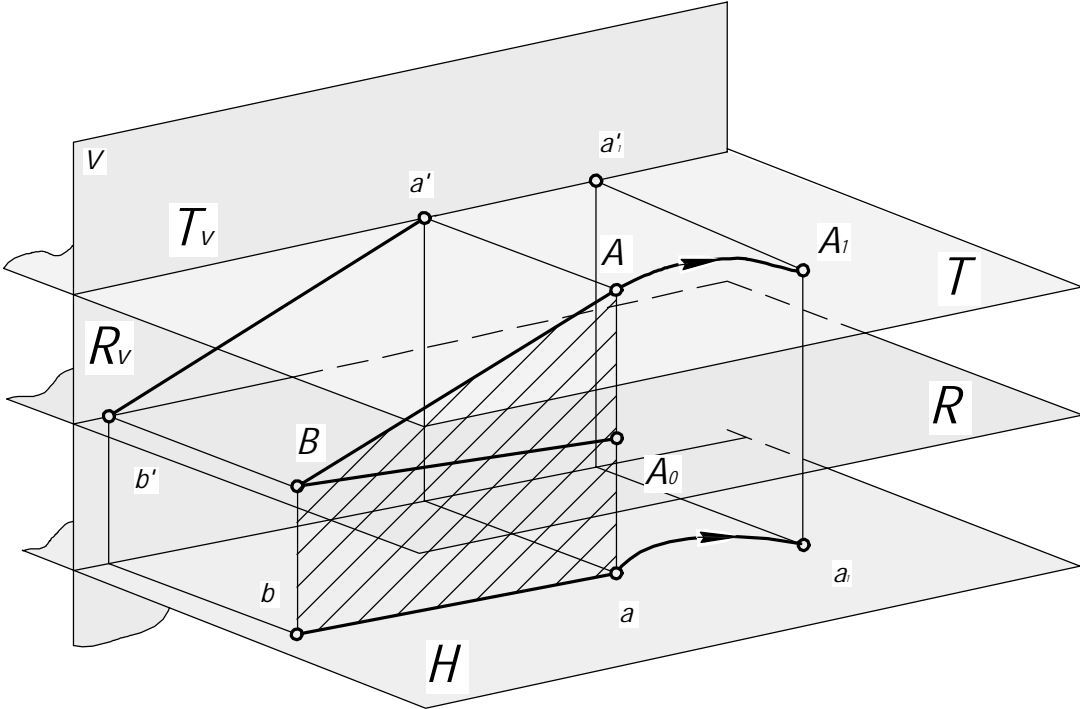

Ἰτ᾿ἰ. ἐ ᾶαὸ	Ἐτ᾿. 1 ᾶαὲ	Ἀῤᾱτ. ἐτ᾿. 1	Ἰτ᾿ἰ. ἐ ᾶαὸ	Ἐτ᾿. 1 ἰτ᾿ᾶ
-------------	------------	--------------	-------------	-------------

Ἐῤῥ.	Ἐἔηὸ	1 ἄῦεὸτ.	Ἰτ᾿ἰ.	Ἀᾶαὸ
------	------	----------	-------	------

Νίϊ η̄ η̄ αὺ ἰ δ᾿ ἰ ἀ δ᾿ ἀ ῥ ἰ ἀ ἰ ἔ ῦ ÷ ἀ δ ᾿ ᾶ ᾱ

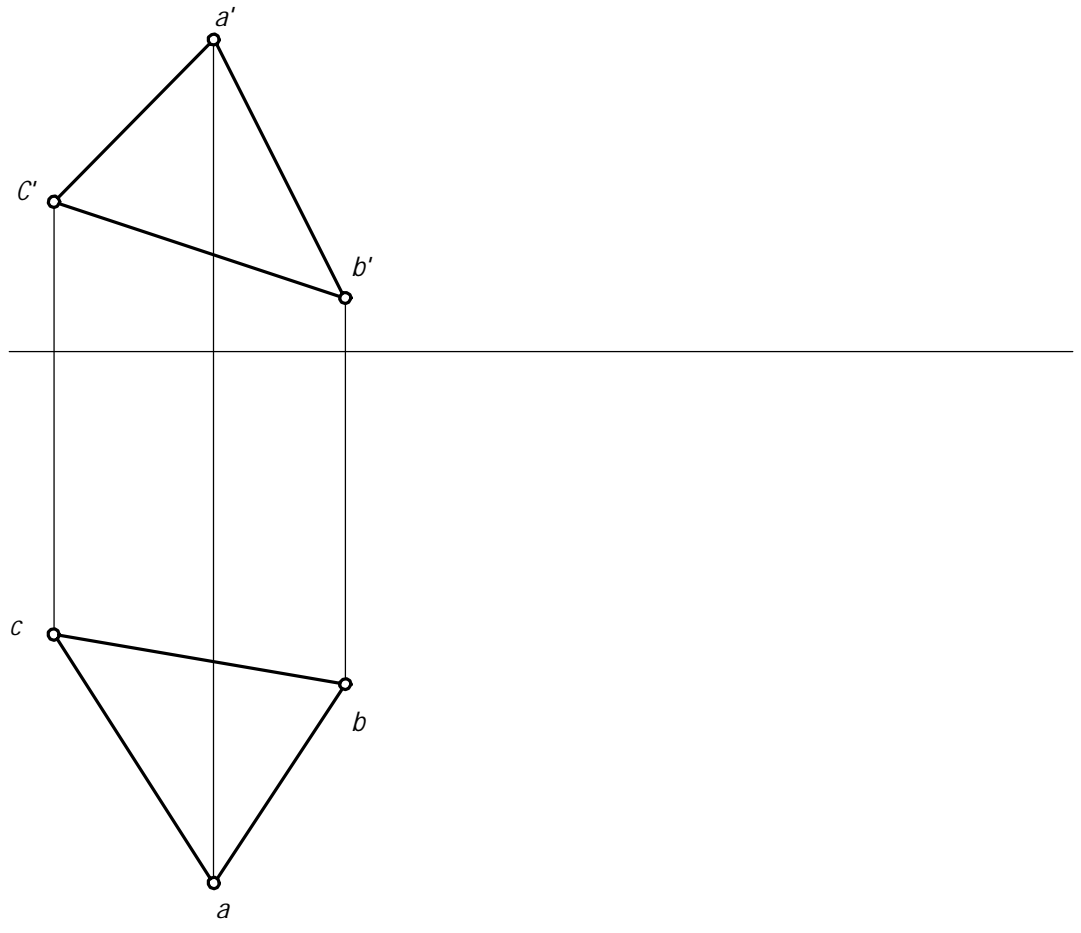

Ñiîñîá ñîáì áúáíèÿ

<i>Éíá ¹ iîáé.</i>	<i>Íîáí. è áàòá</i>	<i>Áçáì. èíá ¹</i>	<i>Éíá ¹ áòáé.</i>	<i>Íîáí. è áàòá</i>
<i>Èçì. Èèò</i>	<i>¹ áîéòì.</i>	<i>Íîáí.</i>	<i>Áàòá</i>	

Μίμησιν ἰθαί ἀδαçí ἀαί εὔ ÷ ἀδὸ ἀα

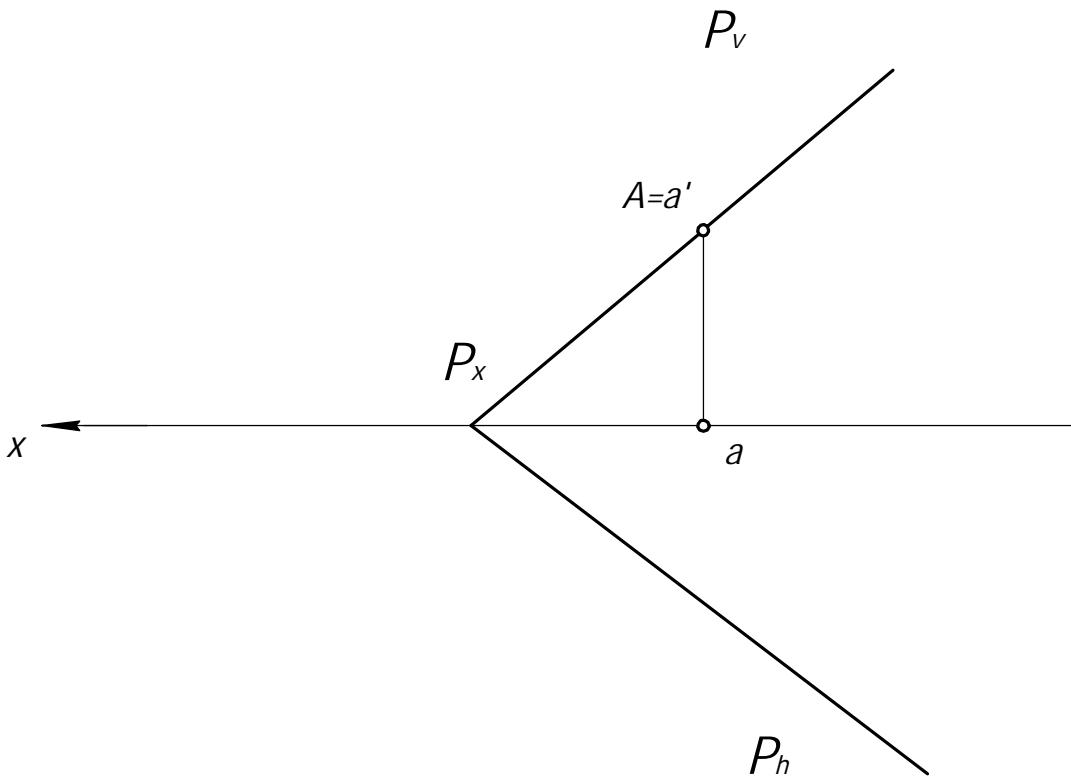
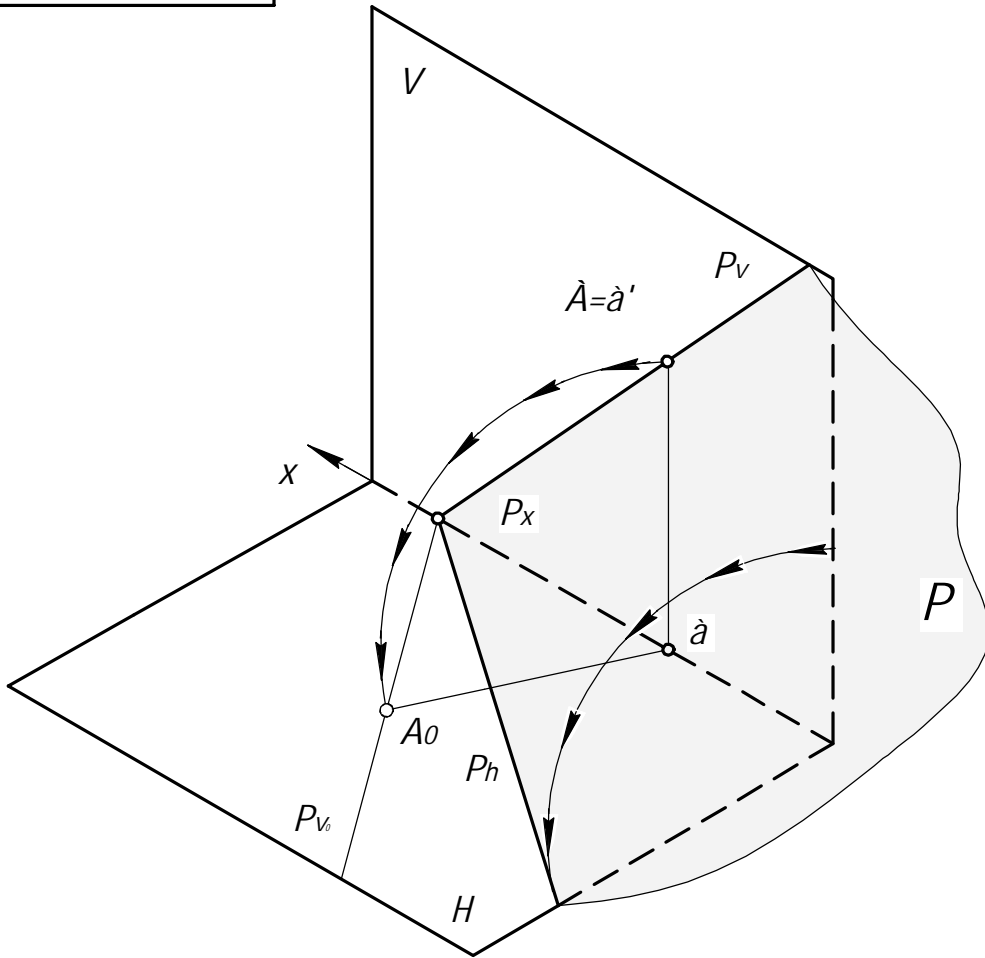

Ἰταί. ἐ ἀαὸ	Ἐἰά. 1 ἀαἰ	Ἄαί. εἰά. 1	Ἰταί. ἐ ἀαὸ	Ἐἰά. 1 ἰταῖ
-------------	------------	-------------	-------------	-------------

Ἐçì.	Ἐἠὸ	1 ἀἠεὸί.	Ἰταί.	Ἄαὸ
------	-----	----------	-------	-----

Ἰταί ἰθαί ἀδαçí ἀαί εὔ ÷ ἀδὸ ἀα

Ἐἠὸ
8

Ci'îñîáú i'đáíáđàçîááíèÿ ÷áđòáæà

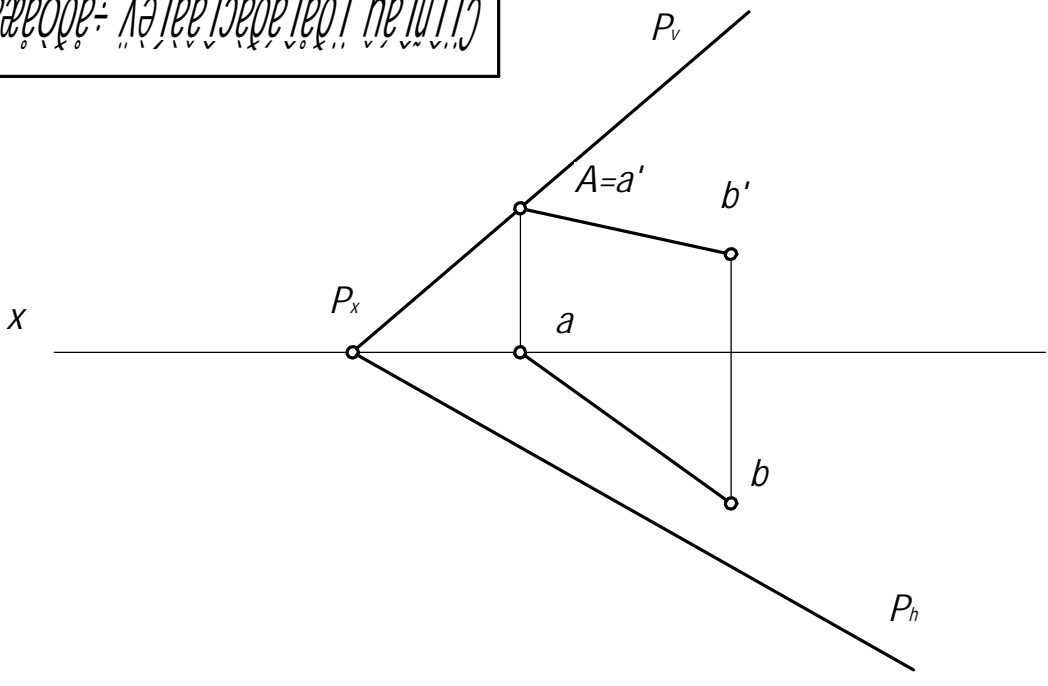

Ñi'îñîá çàì áíú i'èîñèîñòáé i'đíáéöèé

Éíá 1 i'îáé.	Íîáî: è áàòá	Áçáî. èíá 1	Éíá 1 áòáé.	Íîáî: è áàòá
Éçì. Èèò	1 áíéòî.	Íîáî.	Áàòá	

Ci'îñîáú i'đáíáđàçîááíèÿ ÷áđòáæà

Μίμησις ἰσοστάθης ἀπόστασης

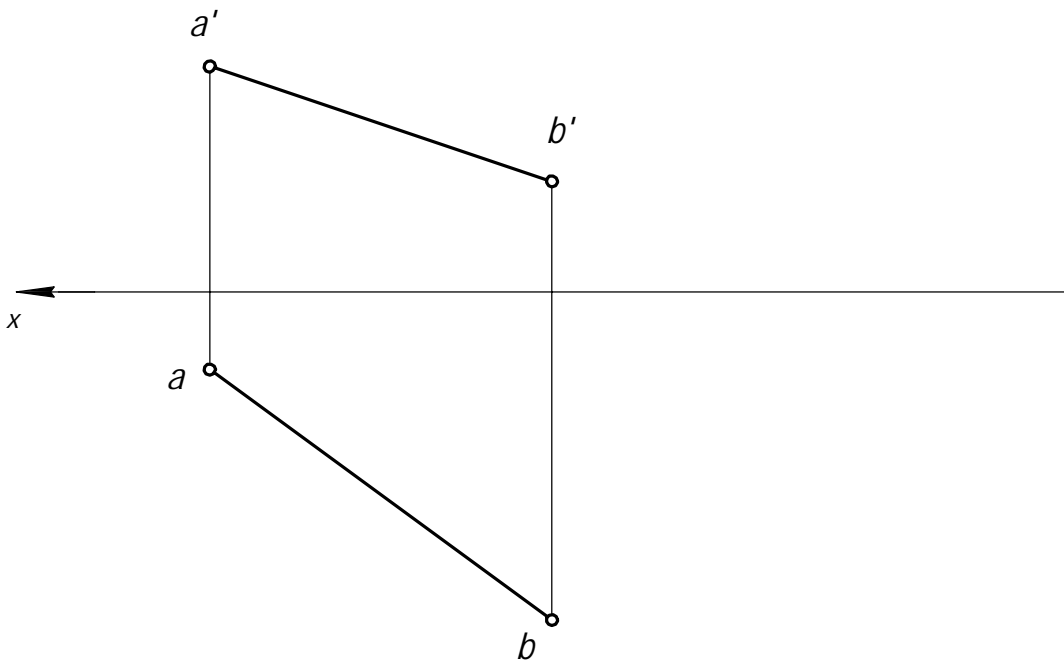
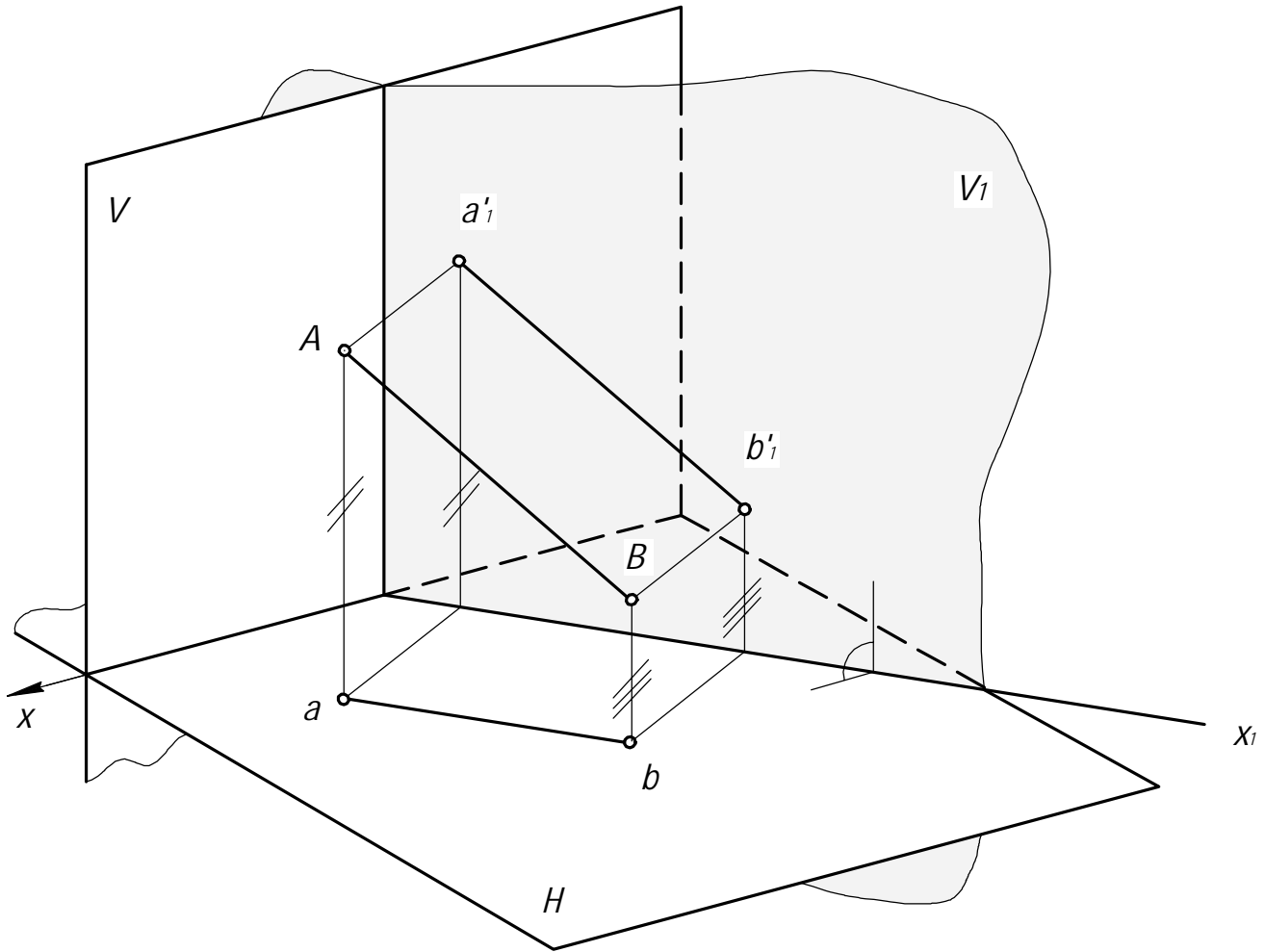

Ἰταί. ἐ ἀποσ	Ἐτά. 1 ἀποσ	Ἀκαί. εἰτά. 1	Ἰταί. ἐ ἀποσ	Ἐτά. 1 ἰταί.
--------------	-------------	---------------	--------------	--------------

Ἐκ.	Ἐνὸ	1 ἀρεσί.	Ἰταί.	Ἀποσ
-----	-----	----------	-------	------

Μίμησις ἰσοστάθης ἀπόστασης

Ἐνὸ
10

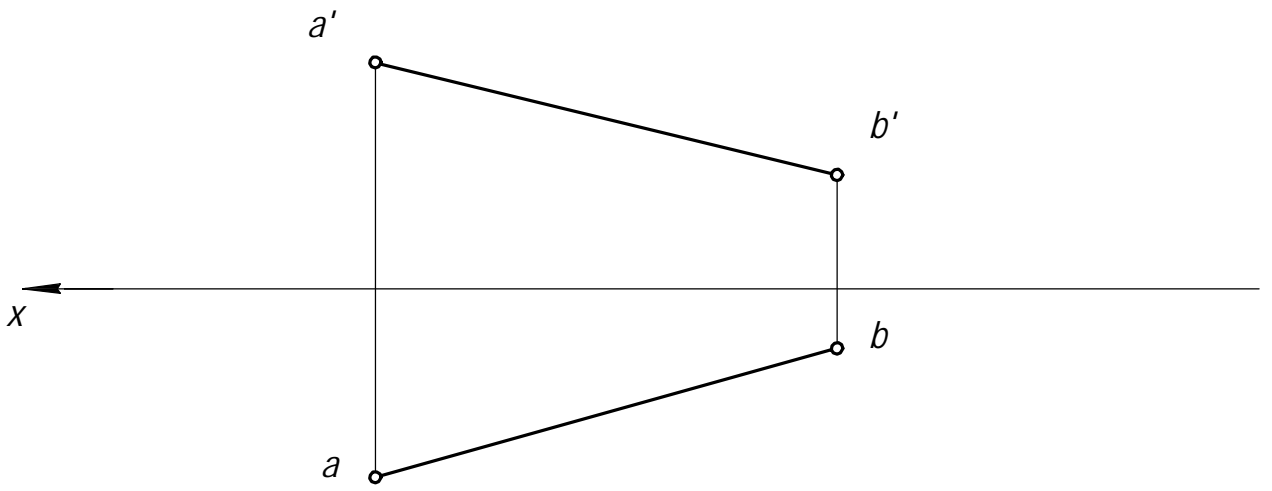

Éĩá 1 i'ĩáé.	Íĩáĩ. è áàòá	Áçãĩ. è íá. 1	Éíá. 1 áòáé.	Íĩáĩ. è áàòá
--------------	--------------	---------------	--------------	--------------

→

×òĩáú i'èĩñéĩñòü íáúáãĩ i'ĩèĩæáíèÿ òđáĩñòĩđì èđĩáàèãñü á i'đĩáöèđòpùòp íáĩáóĩáèĩ í i'đáĩáđaçĩááíèé

→

Μίμνησθε τὴν ἀνάστασιν τοῦ κυρίου ἡμῶν Ἰησοῦ Χριστοῦ

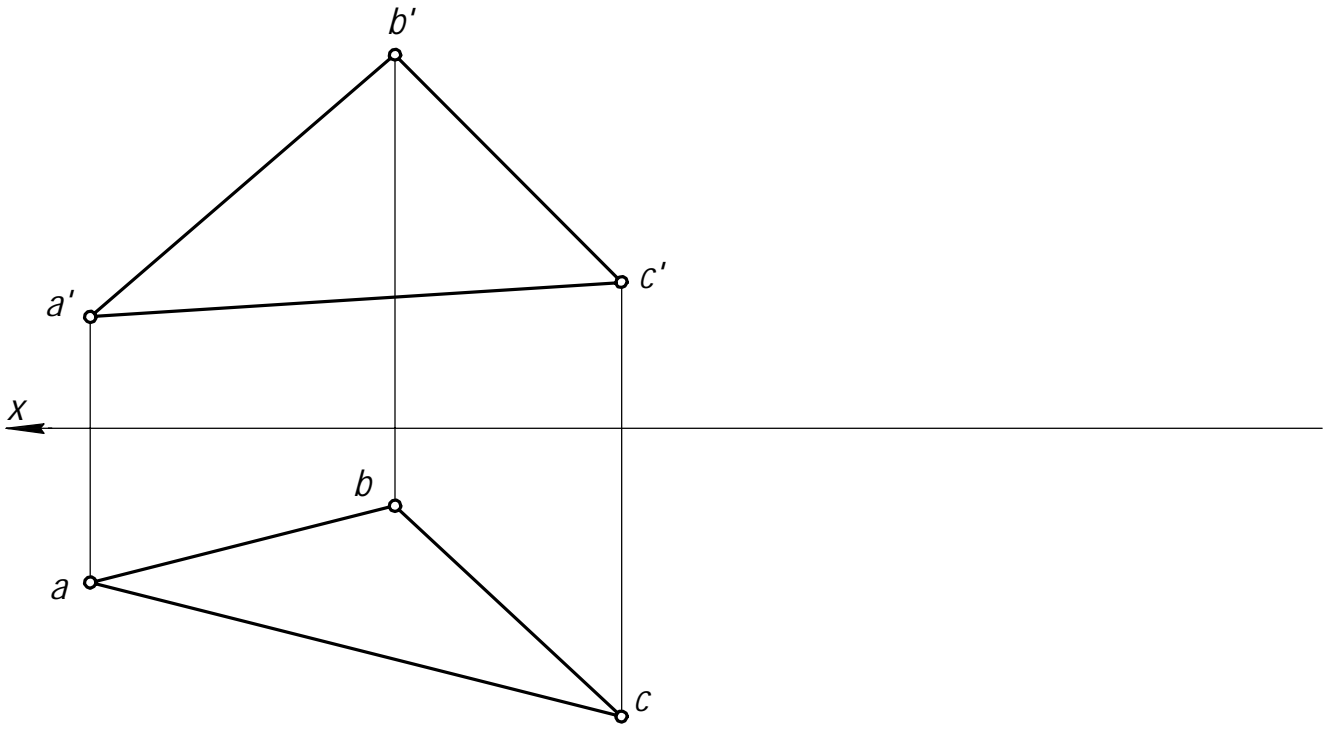

Ἰταί. ἐ ἀαὸα	Ἐἰά. 1 ἀαἶ	Ἀαἰ. εἰά. 1	Ἰταί. ἐ ἀαὸα	Ἐἰά. 1 Ἰταί.
--------------	------------	-------------	--------------	--------------

Ἐἰ.	Ἐἰῶ	1 ἀἰῶ.	Ἰταί.	Ἀαὸα
-----	-----	--------	-------	------

Μίμνησθε τὴν ἀνάστασιν τοῦ κυρίου ἡμῶν Ἰησοῦ Χριστοῦ

Ἐἰῶ
12

Êðèâûâ ëèí èè

Êðèâÿ ëèí èÿ -

Òâðì èí «êðèâÿ» -

Êðèâûâ ëèí èè ðàçäâëÿðò íà ì èîñêèà
è ì ðîñòàíîââííîâ.

Ì èîñêèà -

Ì ðîñòàíîââííîâ -

Î ðâââèèðâü ì îâððîíîñ

Ãâî ì âððè÷âèÿ ÷ àñòü -

Àèâðèè è÷âèÿ ÷ àñòü -

Êðèâ	Ìîââððîíñòè	Êðèâ	Ìîââððîíñòè	Êðèâ	Ìîââððîíñòè
Êðèâ	Ìîââððîíñòè	Êðèâ	Ìîââððîíñòè	Êðèâ	Ìîââððîíñòè
Êðèâ	Ìîââððîíñòè	Êðèâ	Ìîââððîíñòè	Êðèâ	Ìîââððîíñòè
Êðèâ	Ìîââððîíñòè	Êðèâ	Ìîââððîíñòè	Êðèâ	Ìîââððîíñòè
Êðèâ	Ìîââððîíñòè	Êðèâ	Ìîââððîíñòè	Êðèâ	Ìîââððîíñòè
Êðèâ	Ìîââððîíñòè	Êðèâ	Ìîââððîíñòè	Êðèâ	Ìîââððîíñòè
Êðèâ	Ìîââððîíñòè	Êðèâ	Ìîââððîíñòè	Êðèâ	Ìîââððîíñòè
Êðèâ	Ìîââððîíñòè	Êðèâ	Ìîââððîíñòè	Êðèâ	Ìîââððîíñòè
Êðèâ	Ìîââððîíñòè	Êðèâ	Ìîââððîíñòè	Êðèâ	Ìîââððîíñòè
Êðèâ	Ìîââððîíñòè	Êðèâ	Ìîââððîíñòè	Êðèâ	Ìîââððîíñòè

Ëèíáé÷àòùâ ìîâððîíîñòè ñ îäíé íàíðàâÿðùáé

Òèèèíäðè÷âñèàÿ ìîâððîíîñòè

Ìíðàââèèðáü

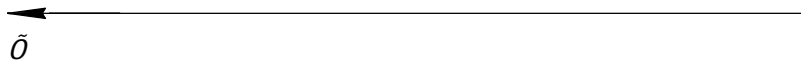

õ

Ëîíè÷âñèàÿ ìîâððîíîñòè

Ìíðàââèèðáü

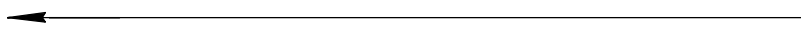

õ

Ìîí. è ðàòà
Ëíà. 1 ðàð.
Àçàí. èíà. 1
Ìîí. è ðàòà
Ëíà. 1 ðàð.

Ëçì.	Ëèò	1 àñèóí.	Ìîí.	Àòà
------	-----	----------	------	-----

Êðèâûâ èèí èè. Ìîâððîíîñòè

Ëèò
2

Êèíáé÷àòùá ìîââðõíîñòè ñ äâóì ÿ Ìàìðàâÿðùè è
Òèèèíäðîèä

Îìðàääèèðáëü



ò

Êîîîéä

Îìðàääèèðáëü

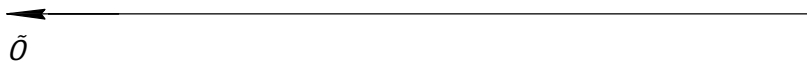

ò

Êíá ¹ ìîâé.	Ìîâì. è äàòà	Êíá. ¹ äâóé.	Ìîâì. è äàòà
Êçì. Êèñò	¹ äìèóì.	Ìîâì.	Äàòà

Ì àðàáî èà

- èðèâÿ âòîðîáî ìîðÿèà,

Ì àðàáî èà

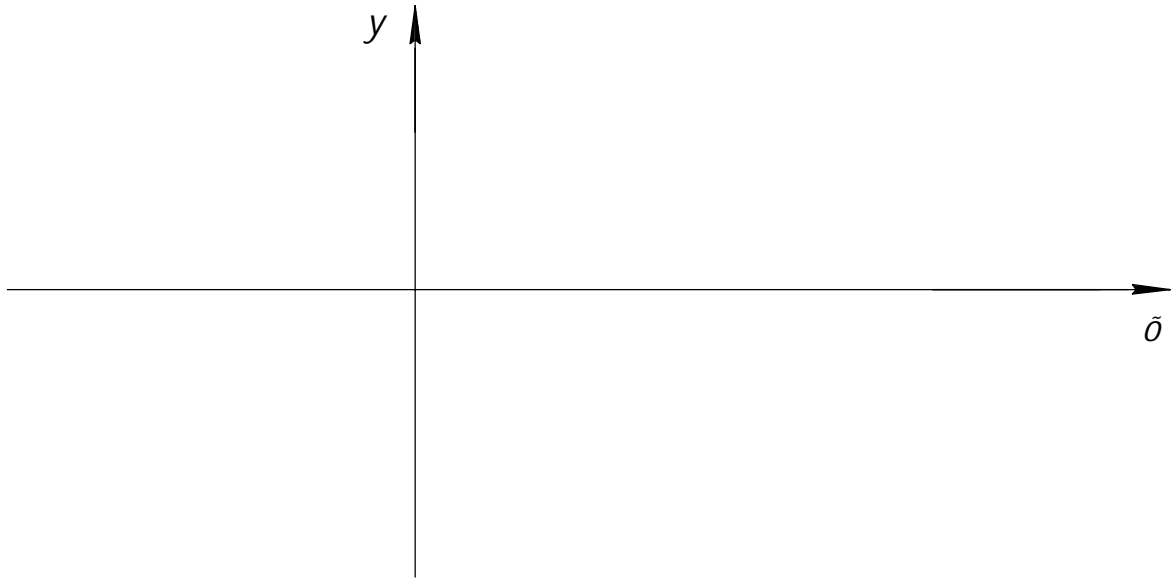

Ãèì áðàáî èà

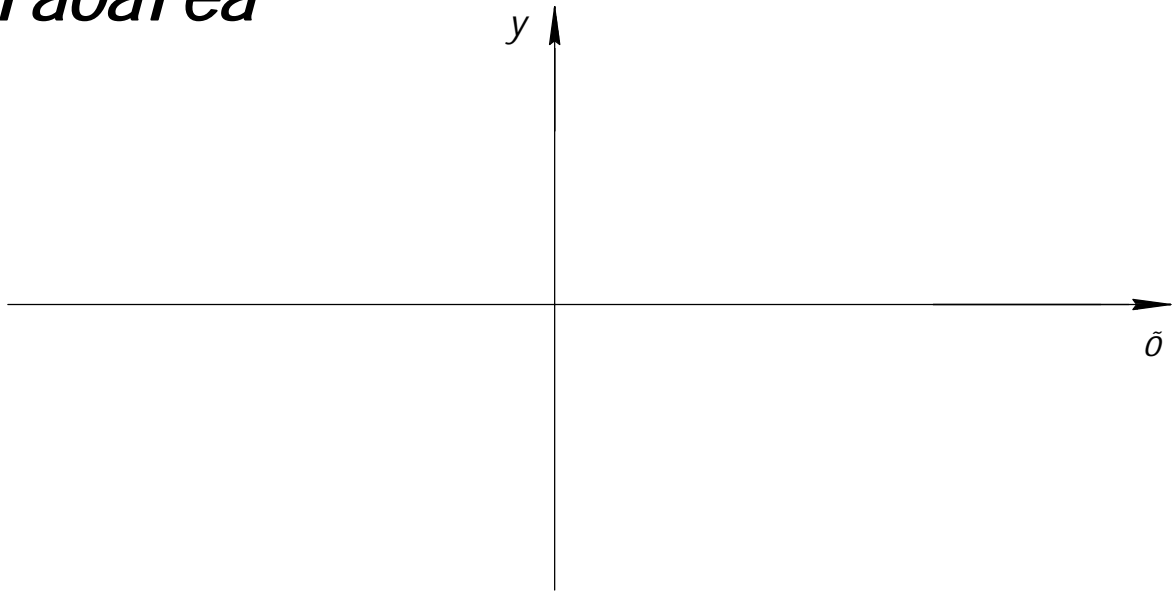

Ìîáî. è ãàòà
Ëîá. 1 ãàè
Ãçàî. èîá. 1
Ìîáî. è ãàòà
Ëîá. 1 ìîáè

Ëçì.	Ëèñò	1 àñèóì.	Ìîáî.	Ãàòà
------	------	----------	-------	------

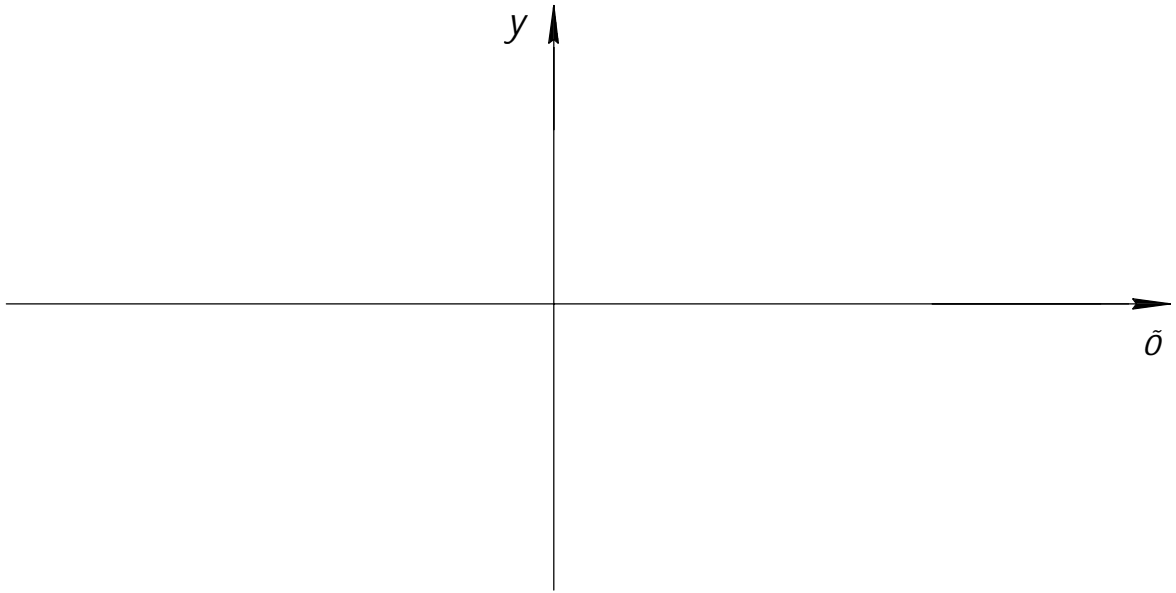

Ñâî èñòââ î ðòî ãî í àëüí ûõ ì ðî âêöèé
êðèâî é èèí èè

1.

2.

3.

4.

5.

Êîá ¹ ìîâè.	Ìîâî: è âàðà
Àçàì. èíá ¹	Êîá ¹ àðàé.
Ìîâî: è âàðà	
Êîá ¹ ìîâè.	

Êçì.	Êèòò	¹ àñèòì.	Ìîâî.	Ààðà	Êðèàúà èèí èè. Ìîâððîíîñè	Êèòò
						5

Òèèèí äðè-âñèèâ ìîâððîíîñðè ìîâððàçääëÿðò:

- 1.
- 2.
- 3.
- 4.

Êððèâñ ìîâððîíîñðè-

Ìîâððîíîñðè äðàùáíèÿ

Ìîðääèèðääü ìîâððîíîñðè

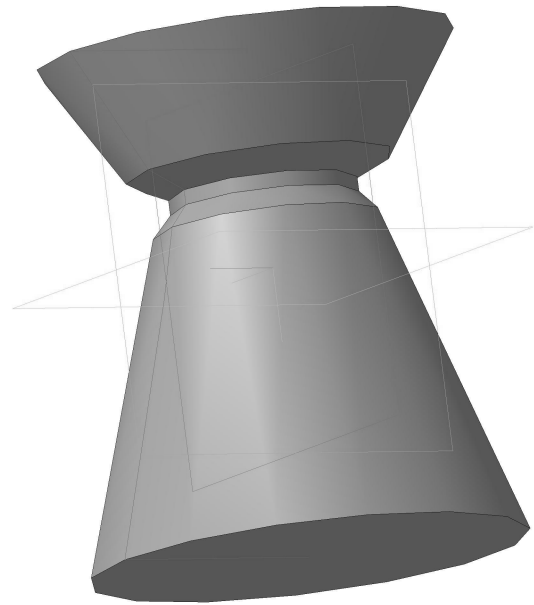
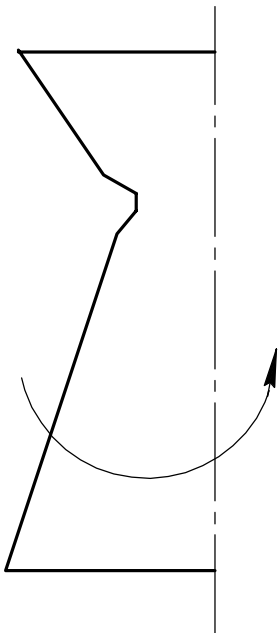

Ìîâí. è ðàòà
Êíà. 1 ðàðè
Âçàí. èíà. 1
Ìîâí. è ðàòà
Êíà. 1 ìíàè

Êçì. Êèòò	1 äñèè.	Ìîâí.	Âððà
-----------	---------	-------	------

Êðèâùâ èèí èè. Ìîâððîíîñðè

ÌÎÂÐÐÎÍÎÑÒÈ ÁÐÀÛÁÍÈß

Èç çàèííà ìáðàçíááíèÿ ìîâððîíîñòè áðàúáíèÿ
âóðåèàðò ààà ìñííáíóñ ñâíèñòàà:

1.

2.

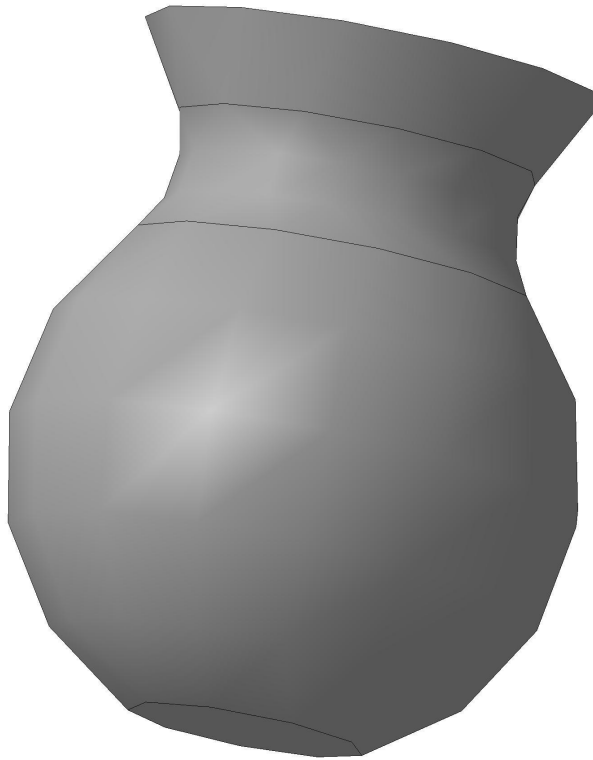

Êíá ¹ ìíáè.	Ìîâí. è ààòà	Áçàì. èíá ¹	Êíá ¹ áððè.	Ìîâí. è ààòà
Êçì. Êèñò	¹ àíèòí.	Ìîâí.	Áàòà	

ÌÎÂÐÐÏÎÈ ÆÐÀÙÁËÈ

Ðàññì ìððèì ìàèáí èáá ðàñì ðì ñððáí áí ìá ìîâððïíîè ÆÐÀÙÁËÈ ñ èðèáí èèí áéí ùì è ìáðàçòðùè è:

Ñòáðà -

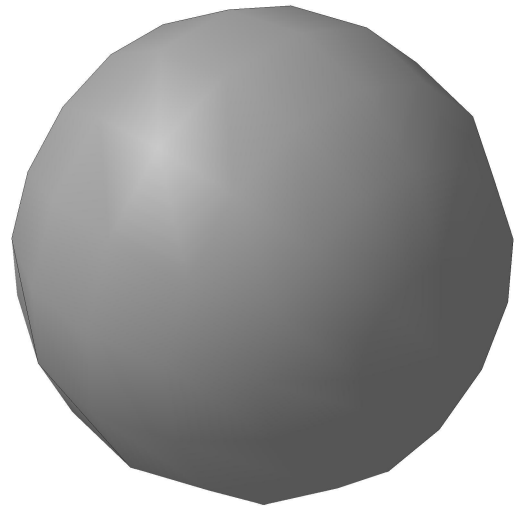
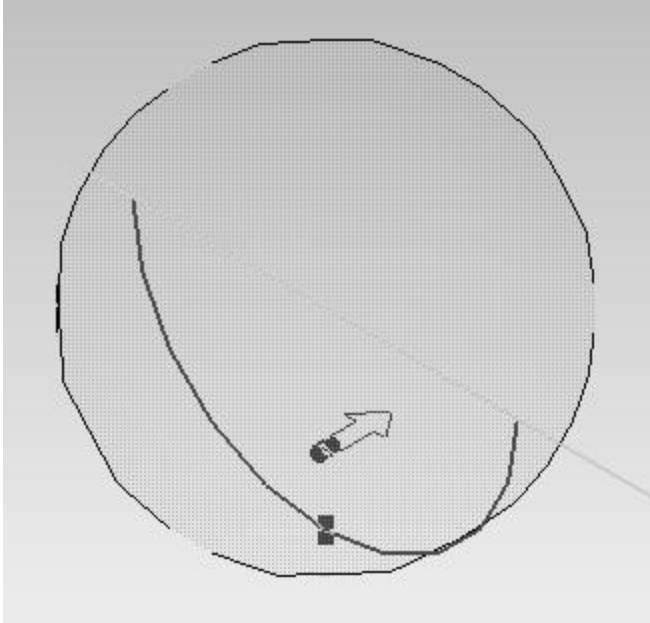

Ìîâ: è áàòà	Ëíà 1 áàè	Áçáì. èíà. 1	Ìîâ: è áàòà	Ëíà 1 ìíàè
-------------	-----------	--------------	-------------	------------

Ëçì.	Ëèò	1 áñèóì.	Ìîâ:	Áàðà
------	-----	----------	------	------

Êðèáûâ èèí èè. Ìîâððïíîè

Ýèèèìñî èäù

Î áðàçîâáí èá áùðýí óðîîáî ýèèèìñî èää

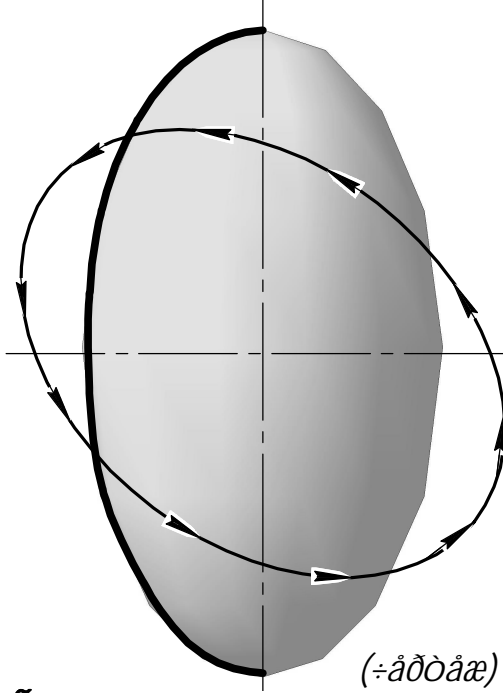

Ñæàòùé ýèèèìñî èää èèè ñòáðîí èäîî

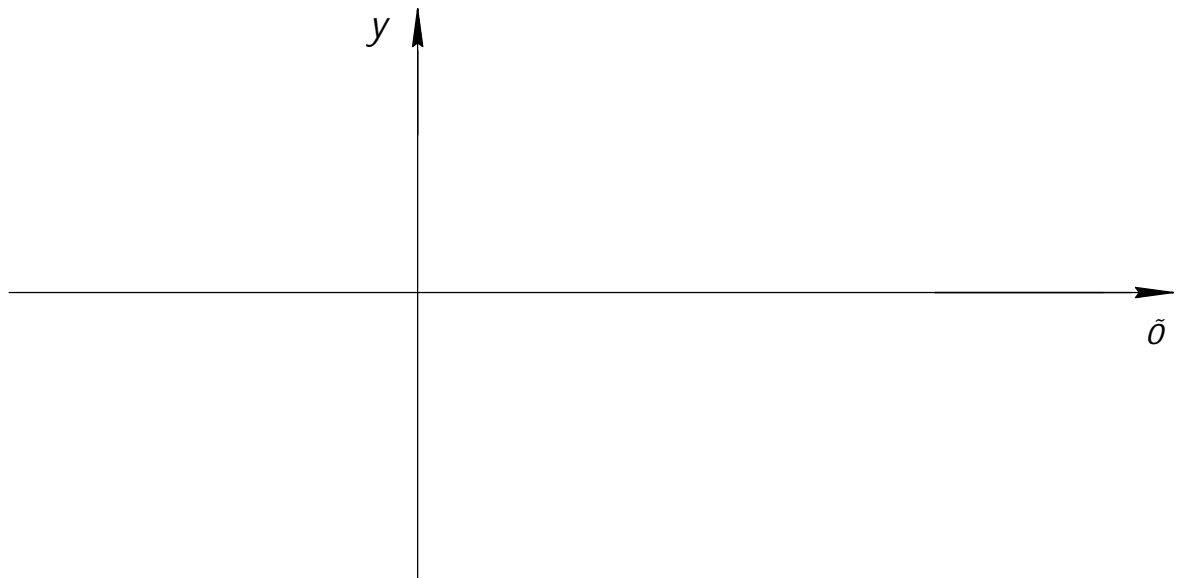

Êíá ¹ ìîáè.	Îîáî: è äàðá	Áçáî. èíá ¹	Êíá ¹ áðáè.	Îîáî: è äàðá
Êçì. Êèñò	¹ áñèóî.	Îîáî.	Áäàðá	Êèñò

Òîð -

Òîð

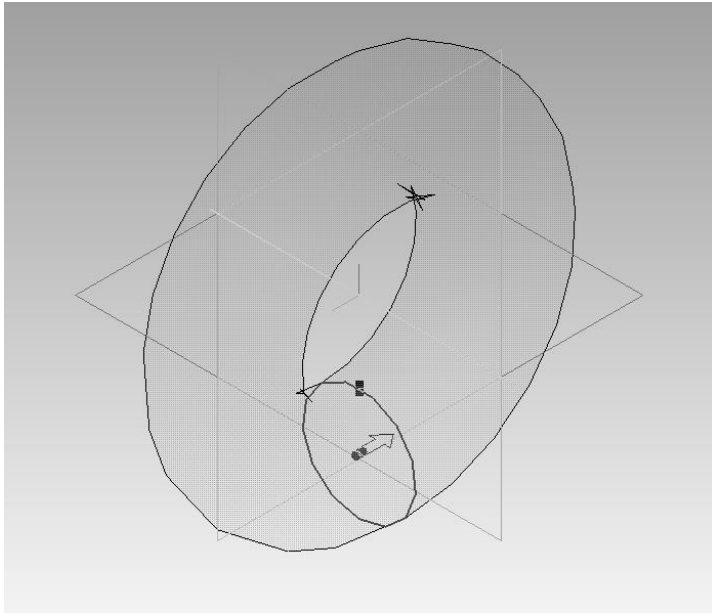

(=âððáæ)

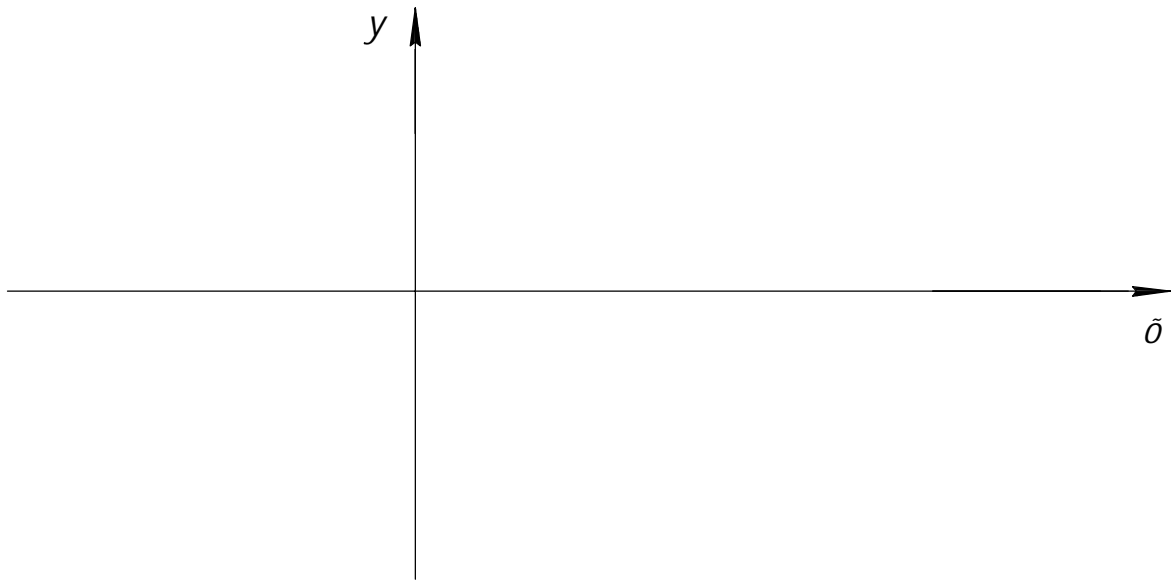

Ìîâ: è ðàòà
Ëíà 1 ðàðè
Áçàì. èíà. 1
Ìîâ: è ðàòà
Ëíà 1 ìñàè

Ëçì.	Ëèòò	1 àñèóì.	Ìîâ:	Áàòà
------	------	----------	------	------

Êðèâûâ èèí èè. Ìîâððõíîñòè

Ëèòò
10

Ἰἶ ἄḡḡḡḡ ἔῖ ἔἄ ἄḡḡḡḡ ἔῖ -

Ἰἶ ἄḡḡḡḡ ἔῖ ἔἄ ἄḡḡḡḡ ἔῖ

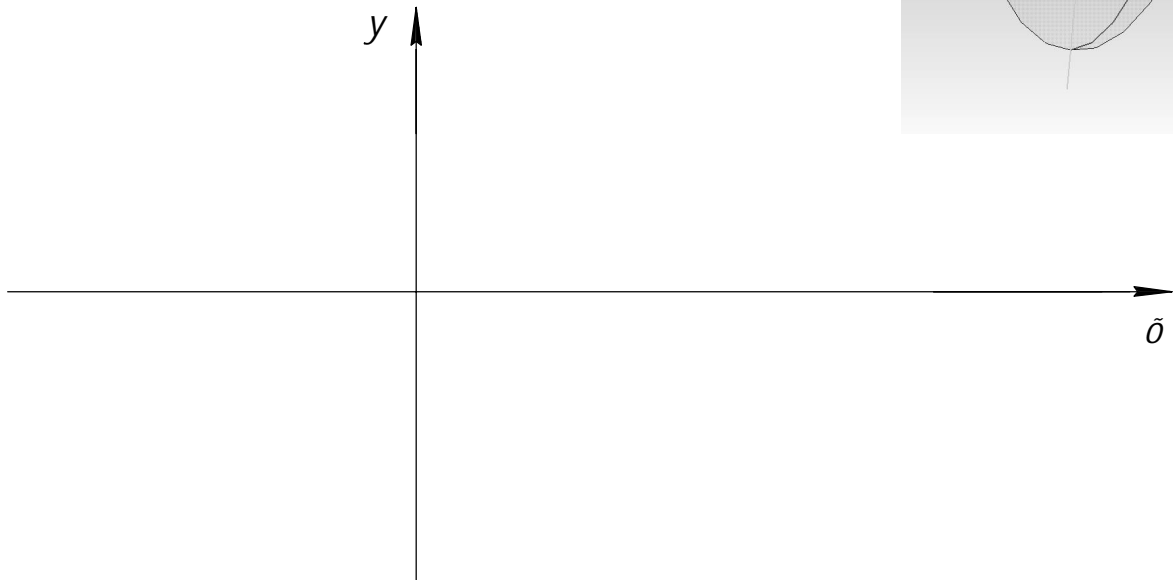
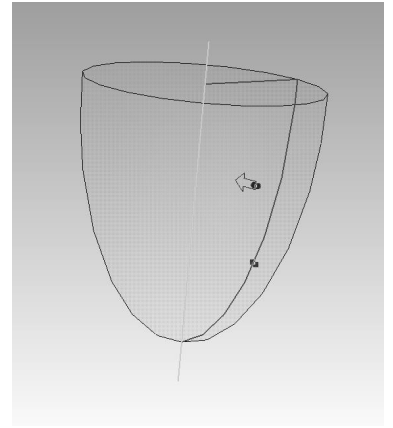

Ἄῖ ἄḡḡḡḡ ἔῖ ἔἄ ἄḡḡḡḡ ἔῖ

ḡḡḡḡḡḡḡḡḡḡ ἄḡḡḡ ἔ ἄḡḡḡ Ἰἶ ἔῖ Ἰἶ ἄḡḡḡḡ ἔῖ ἔἄ ἄḡḡḡḡ ἔῖ.

Ἐῖ ἄḡḡḡḡ	Ἰἶ ἄḡḡḡḡ	Ἄḡḡḡ ἔῖ ἄḡḡḡ	Ἰἶ ἄḡḡḡḡ	Ἰἶ ἄḡḡḡḡ
Ἐῖ	Ἐῖ	ἄḡḡḡḡ	Ἰἶ ἄḡḡḡḡ	Ἄḡḡḡ

Ãèì áðáí èî èä äðàùá èÿ

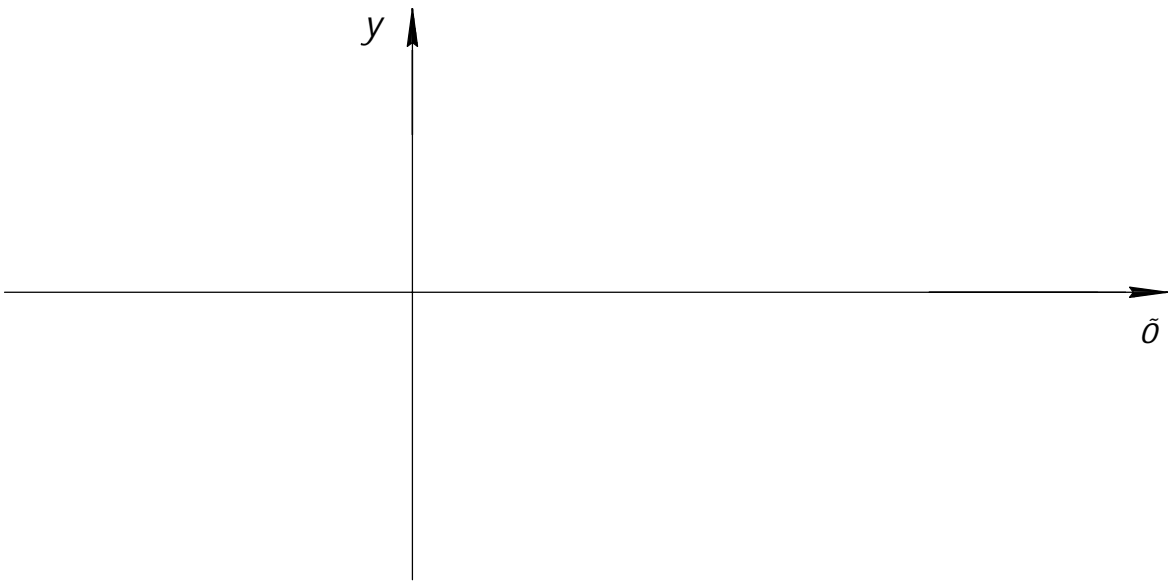
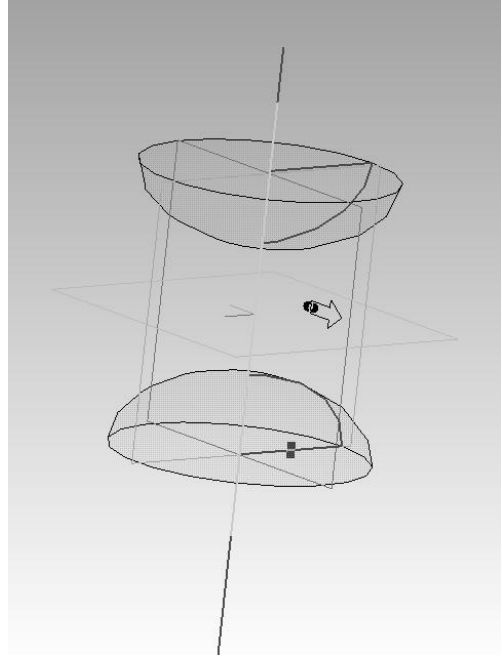
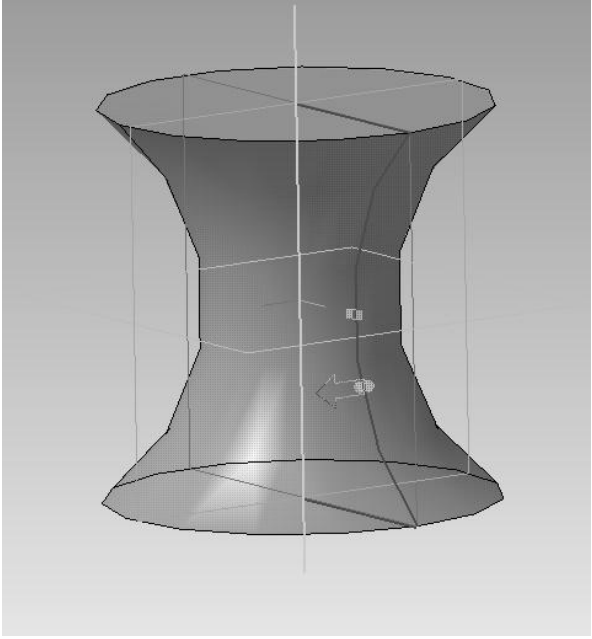

Îîâí. è äððà	Ëíà. 1 äððè	Ãçáí. èíà. 1	Îîâí. è äððà	Ëíà. 1 ìíàè
--------------	-------------	--------------	--------------	-------------

Ëçí. Ëèòò	1 äíèóí.	Îîâí.	Ãððà
-----------	----------	-------	------

Êðèâûâ èèí èè. Îîâððóíî ñòè

Ëèòò
12

Ἀπειροσφαιρική ἰσομετρία

Ἐπιπέδου ἰσομετρίας ἀπειροσφαιρική ἰσομετρία

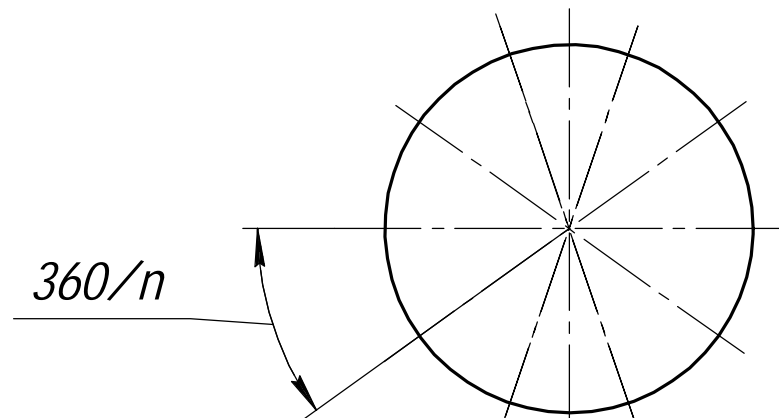
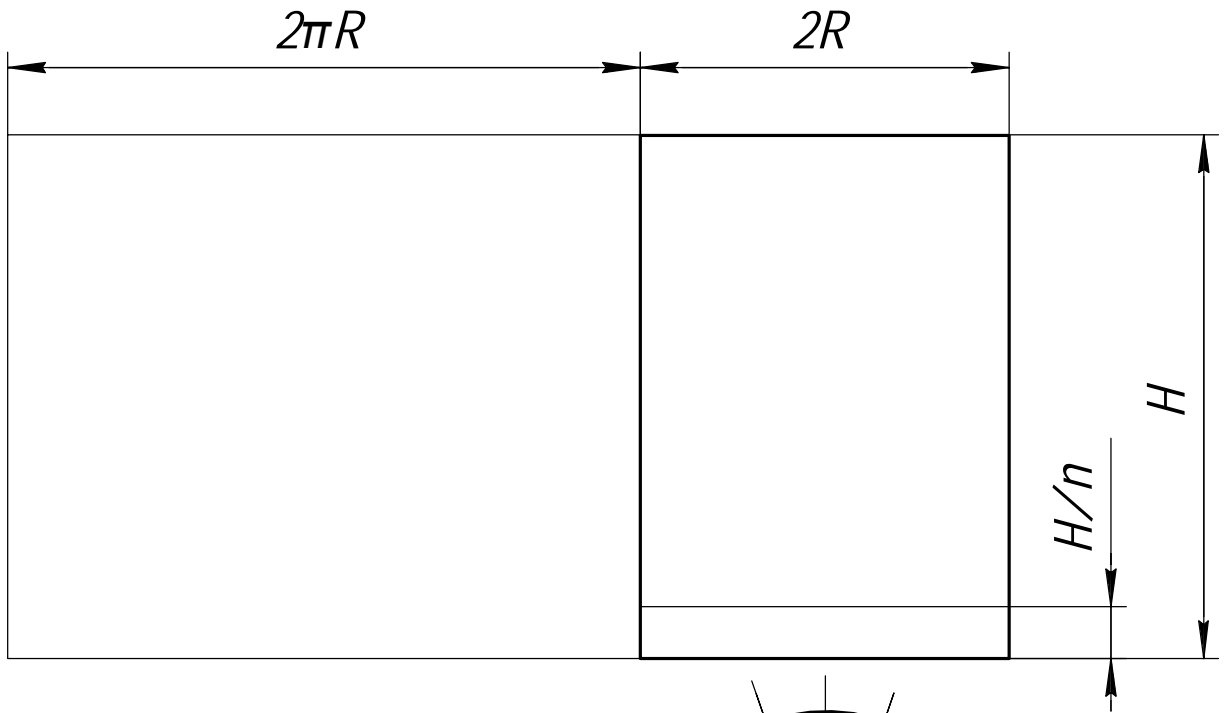
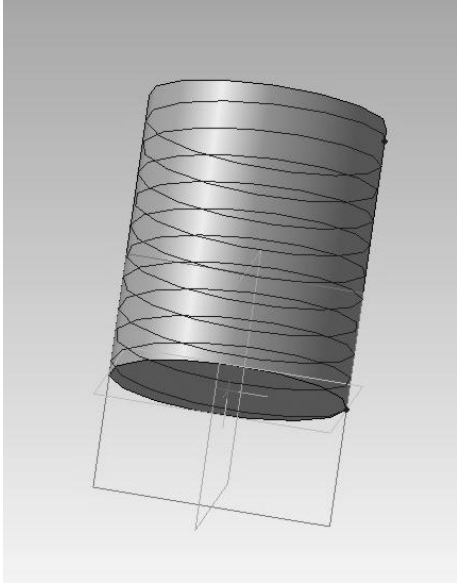

Εἰσαγωγή	ἰσομετρία	ἰσομετρία	ἰσομετρία	ἰσομετρία
ἰσομετρία	ἰσομετρία	ἰσομετρία	ἰσομετρία	ἰσομετρία
ἰσομετρία	ἰσομετρία	ἰσομετρία	ἰσομετρία	ἰσομετρία
ἰσομετρία	ἰσομετρία	ἰσομετρία	ἰσομετρία	ἰσομετρία
ἰσομετρία	ἰσομετρία	ἰσομετρία	ἰσομετρία	ἰσομετρία

Êîí è ãñêàÿ âèí òí âàÿ èèí èÿ

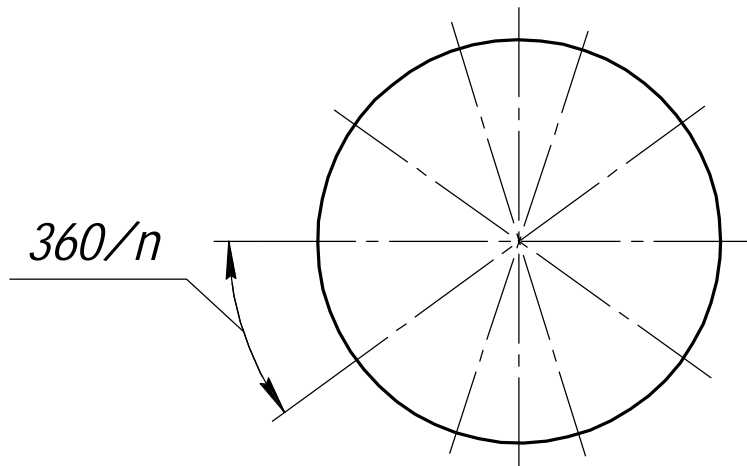
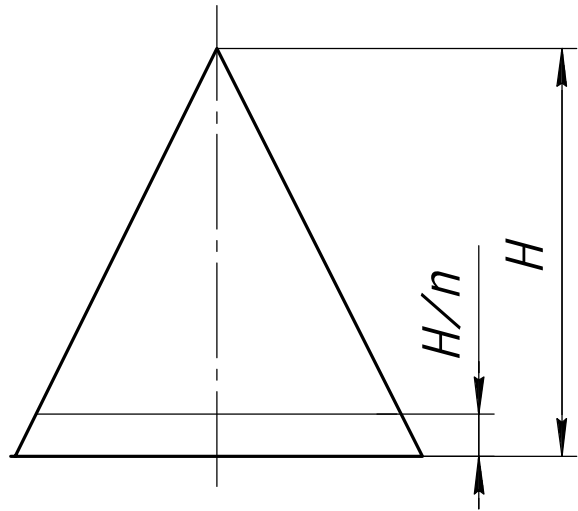
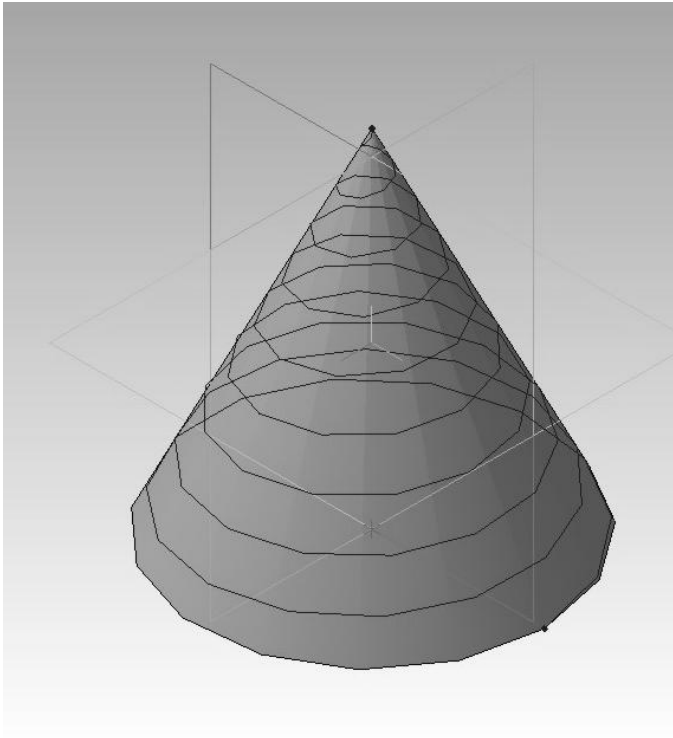

Ìîâí. è ãàà	Êíà 1 ãàà	Âçàí. èíà 1	Ìîâí. è ãàà	Êíà 1 Ìîâí.
-------------	-----------	-------------	-------------	-------------

Êçì.	Êèñò	1 ãñêòí.	Ìîâí.	Âàà
------	------	----------	-------	-----

Ìîâððîíîñòè òí÷áê Ìà ìîâððîíîñòè òáë
 áðàùáí èÿ

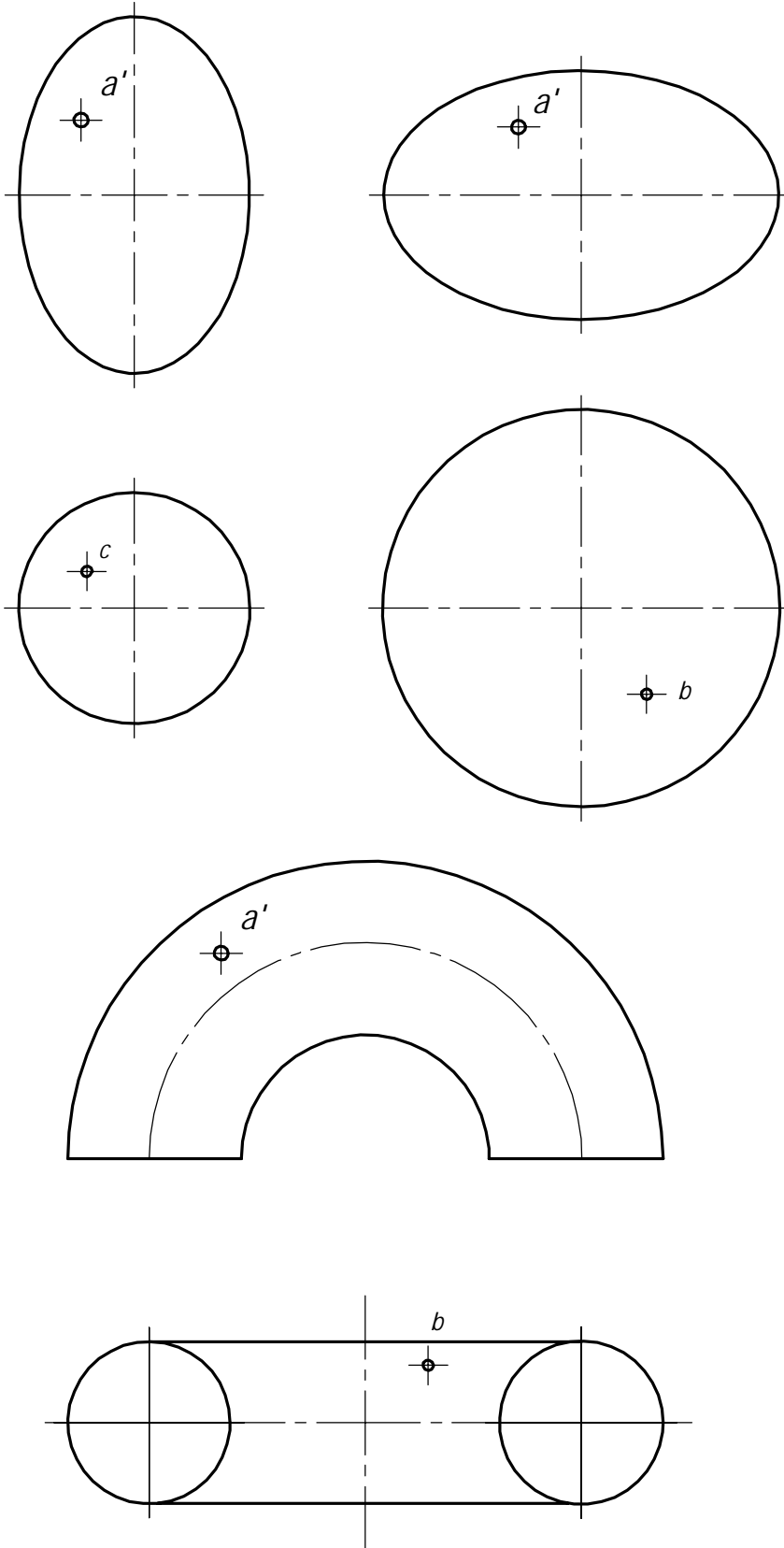

Éíá 1 ìîâðð.	Ìîâðð. è áàðà	Áçàì. è íá. 1	Éíá. 1 áðáé.	Ìîâðð. è áàðà
Éçì. Èèñò	1 áñèòì.	Ìîâðð.	Áàðà	

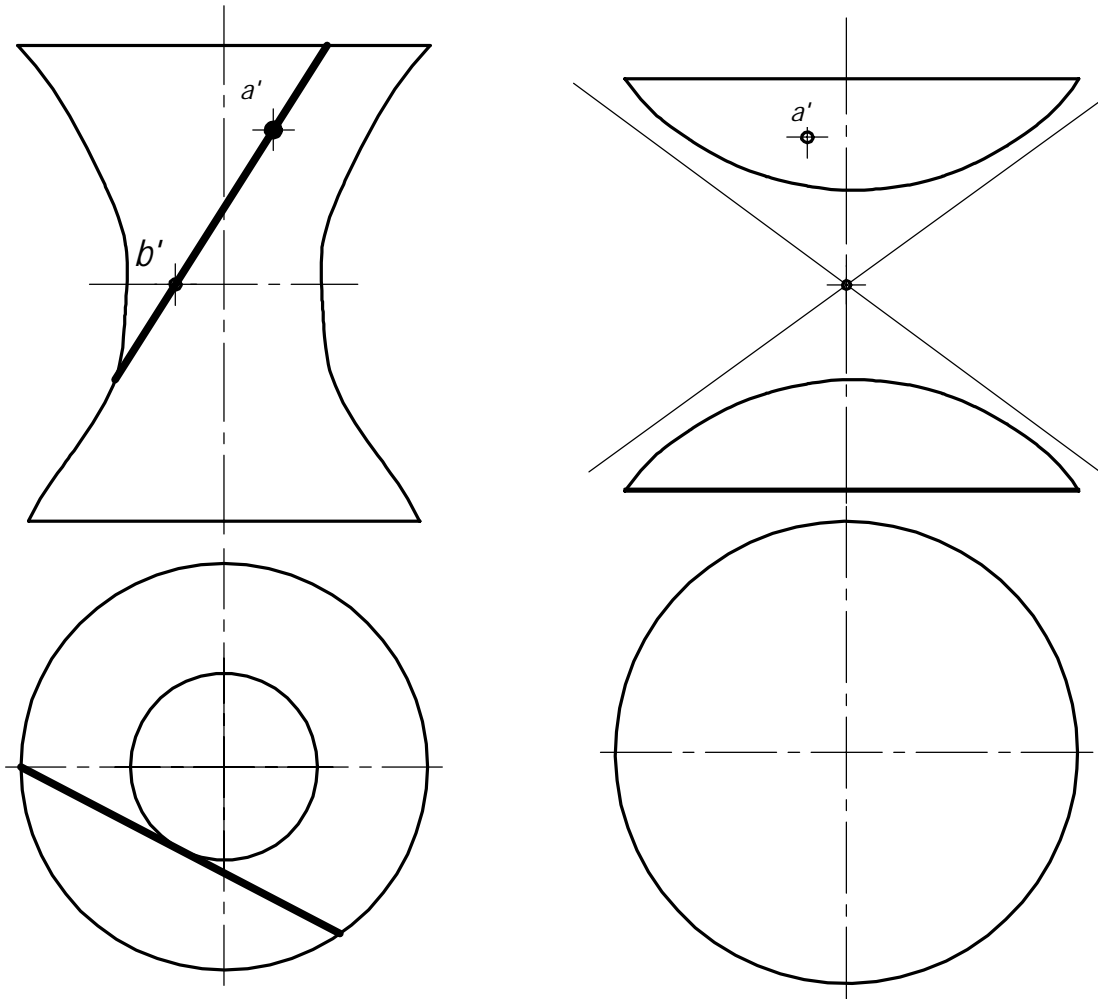

Ãðàííûõ òàè

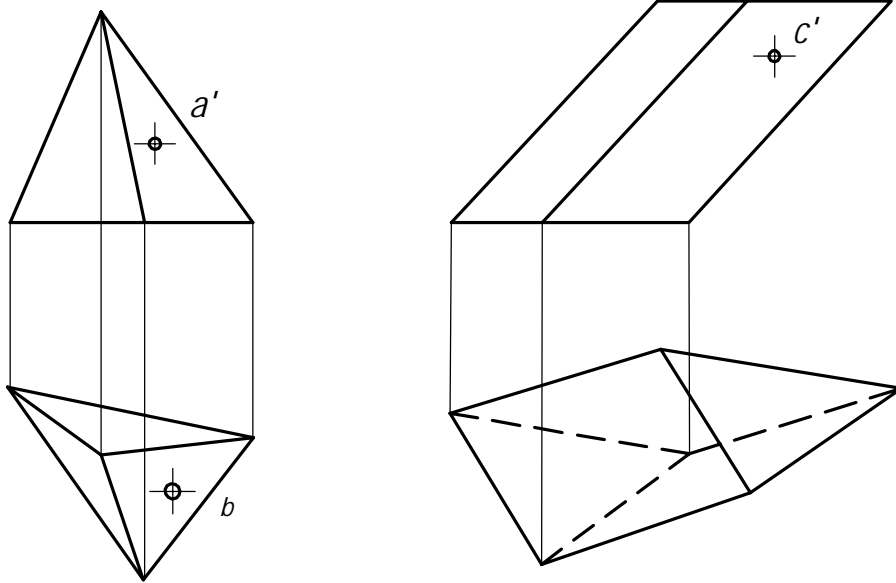

Ìîâí. è ðàòà	Èíà. 1 ðàðè	Ãçàí. èíà. 1	Ìîâí. è ðàòà	Èíà. 1 ððàè
--------------	-------------	--------------	--------------	-------------

Èçì.	Èèòò	1 àñèóì.	Ìîâí.	Ãðàòà
------	------	----------	-------	-------

ÌÁÐÃÑÃ×ÁÍÈÁ ÌÔÃÐÕÍÔÑÒÈ ÌËÔÑËÔÑÒÛÐ

Ìáðãñã÷áíèá ìëôñêôñòùð òáè ñ ìàðàèèáèüíüì è ìáðàçóðùèì è (ìðèçì ù è òèèèíáðù).

Ìðîñòáéøèá ñã÷áíèá ìîéó÷àðò ìëôñêôñòùì è, ìàðàèèáèüíüì è ìëôñêôñòùì ìðîáèèè:

- 1) òðîíòàèèííé
- 2) áìðèçìíòàèèííé ìëôñêôñòùì

ÌÁÐÃÑÃ×ÁÍÈÁ ÌÔÃÐÕÍÔÑÒÈ ÌËÔÑËÔÑÒÛÐ

Ìá 1 ìáè.	Ìîâ. è áàòà	Áçàì. èíá. 1	Ëíá. 1 áðé.	Ìîâ. è áàòà
Ëçì. Èèò	1 áíèò.	Ìîâ.	Áàòà	

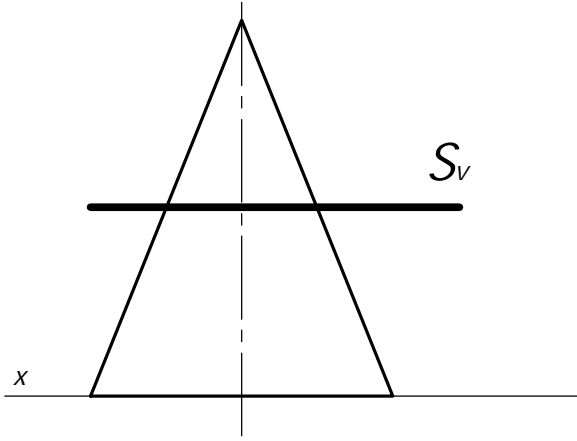

Âñêê ñâêóóàÿ _____

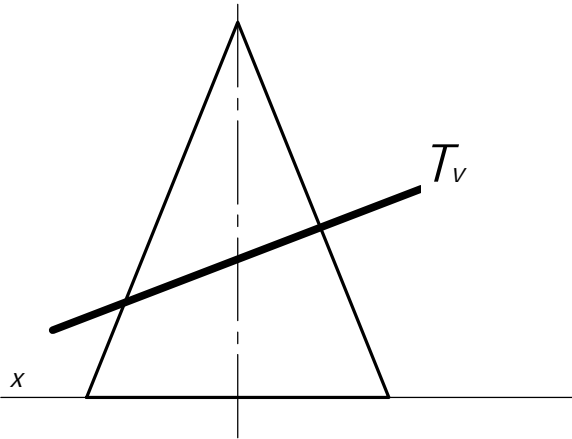

Âñêê ñâêóóàÿ _____

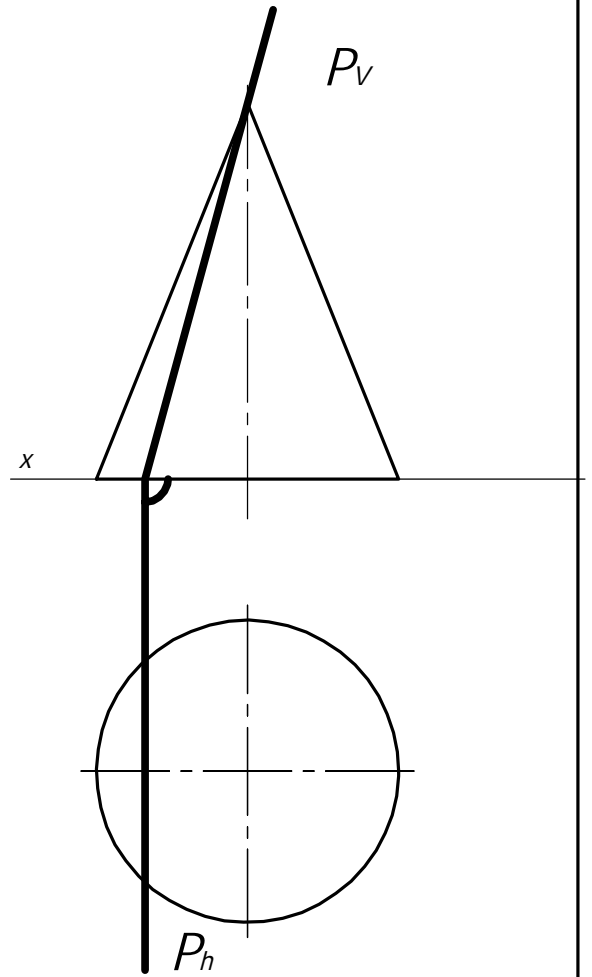

Âñêê ñâêóóàÿ _____

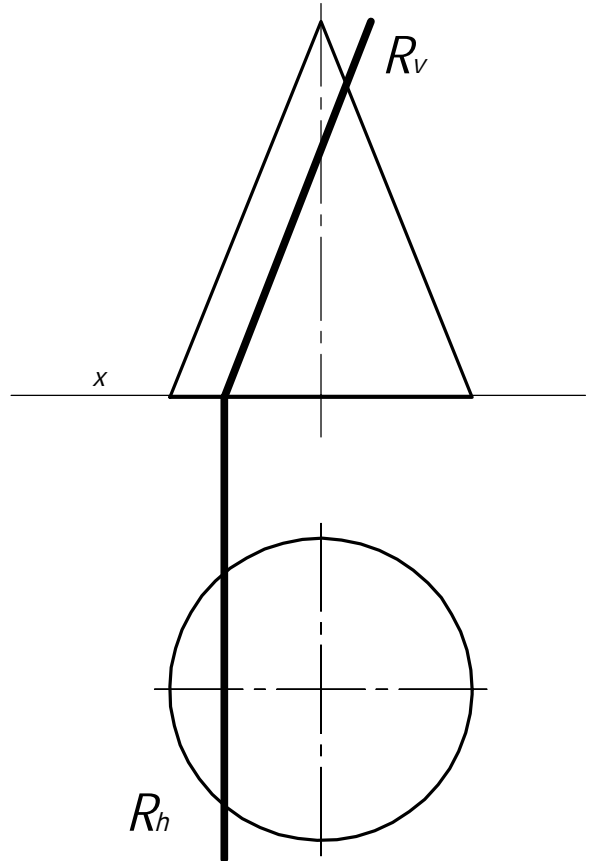

Âñêê ñâêóóàÿ _____

Îîâí. ê ãàòà	Ëíà. 1 ãàòê	Âçâí. êíà. 1	Îîâí. ê ãàòà	Ëíà. 1 Îîâí.
--------------	-------------	--------------	--------------	--------------

Ëçí.	Ëêñò	1 àñêóí.	Îîâí.	Âàðà
------	------	----------	-------	------

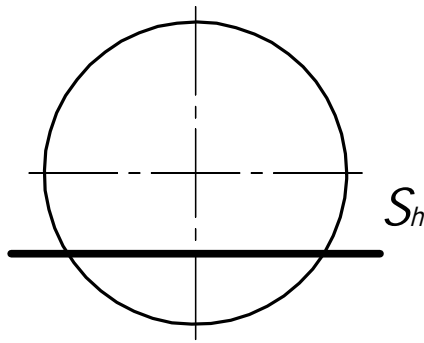
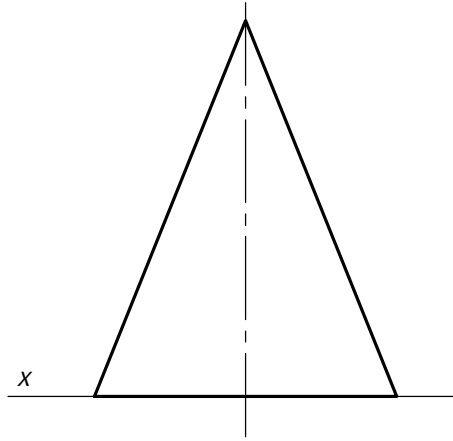

Áñèè ñâéóùàÿ _____

Ñâ÷áí èÿ ìðÿì îâì èððáì áì áì òèèèí äðà.

Êía 1 ìîâé.	Ìîâì: è ààðà	Êía 1 áðáé.	Ìîâì: è ààðà
Êçì.	Êèñò	1 áñéóì.	Ìîâì.
Êçì.	Êèñò	1 áñéóì.	Ìîâì.

Êçì.	Êèñò	1 áñéóì.	Ìîâì.	Áàðà
------	------	----------	-------	------

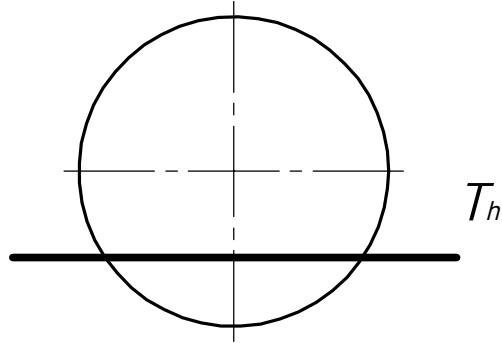
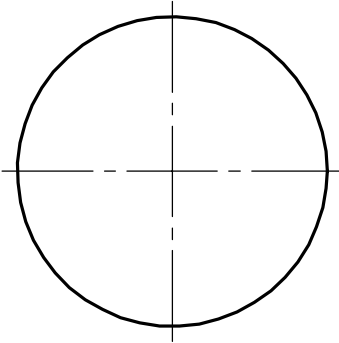
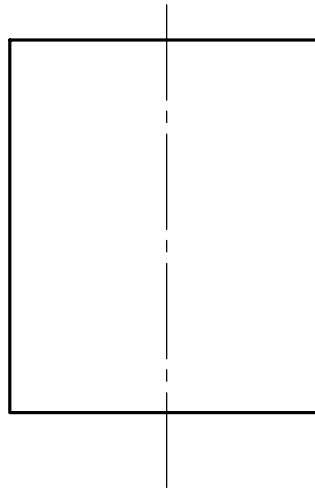
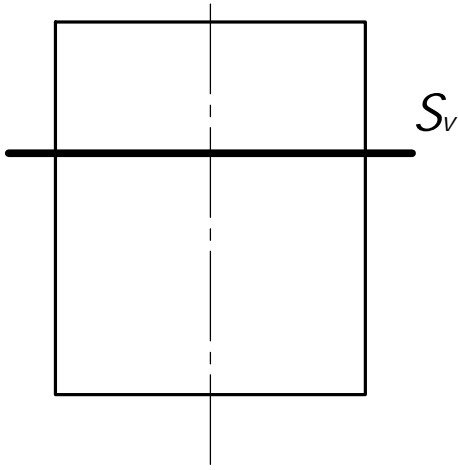

Áñèè ñåéóùäý _____

Áñèè ñåéóùäý _____

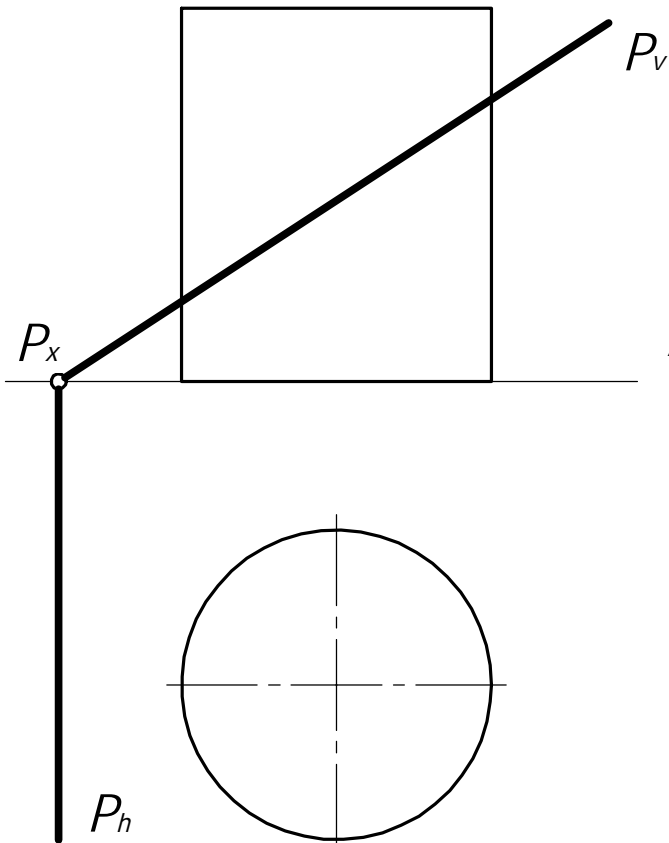

Áñèè ñåéóùäý _____

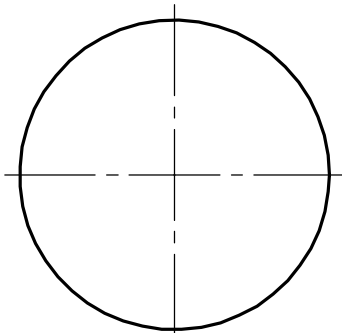

Ëçì.	Ëèò	¹ àñéóì.	Îîåí.	Áàðà
------	-----	---------------------	-------	------

Îîåí. è áàðà	Ëñà. ¹ áàðè	Áçàì. èñà. ¹	Îîåí. è áàðà	Ëñà. ¹ ðñàè
--------------	------------------------	-------------------------	--------------	------------------------

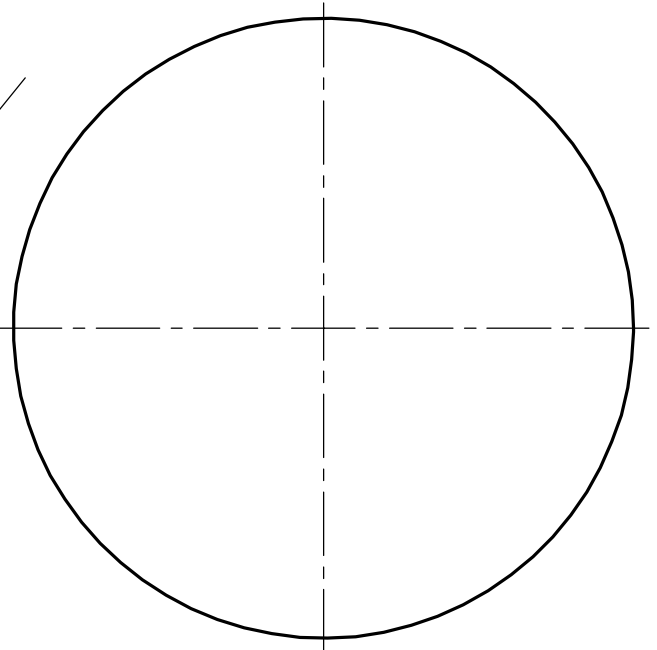
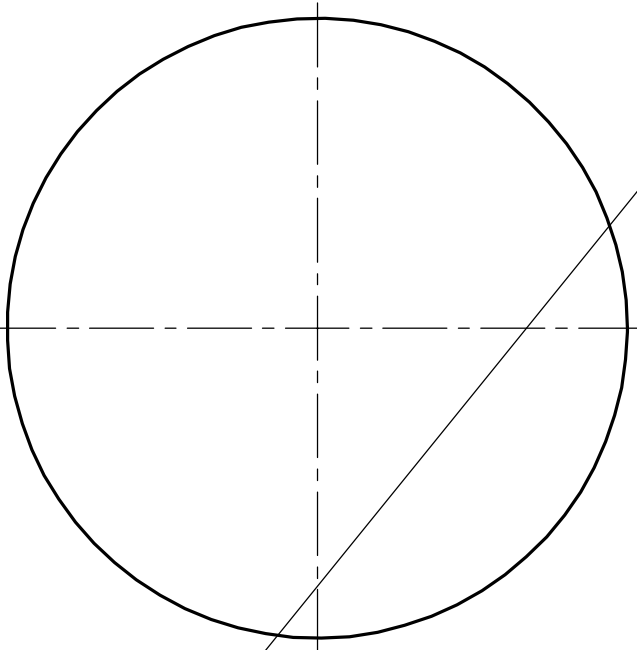
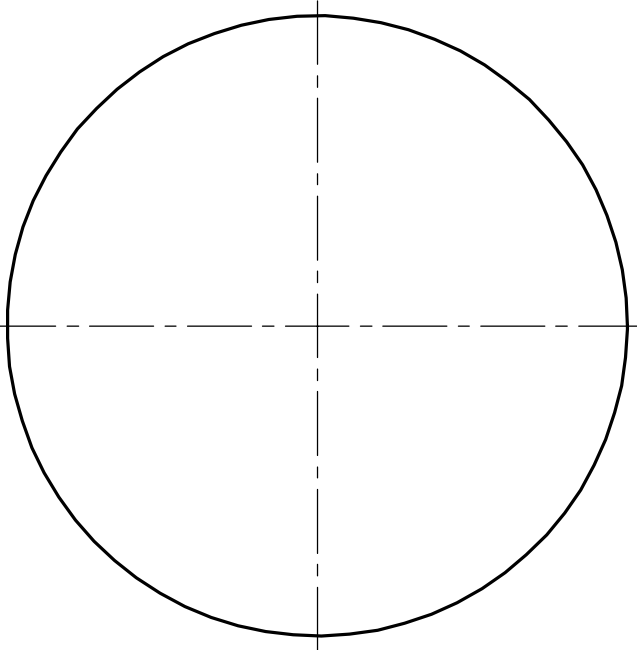
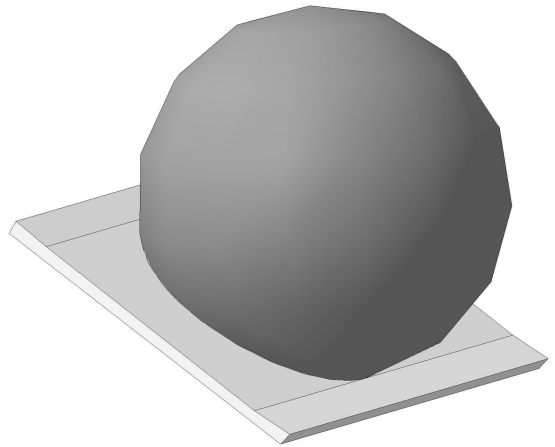

Êíá 1 ìîâè.	Ìîâí: è âàðà	Àçàì. èíá 1	Êíá 1 âðâé.	Ìîâí: è âàðà
Êçì. Êèòò	1 àíèòì.	Ìîâí.	Àâðà	

Ì'ÁÐÁÑÃ×ÁÍËÁ ÕÎ×ÁË Ì'ÁÐÁÑÃ×ÁÍËß Ì'ÐßÌ Ì É Ñ
 Ì Ì'ÁÂÐÕÌ Ì ÑÕÛß Ì È Ì ÑÈ Ì ÑÒÈ

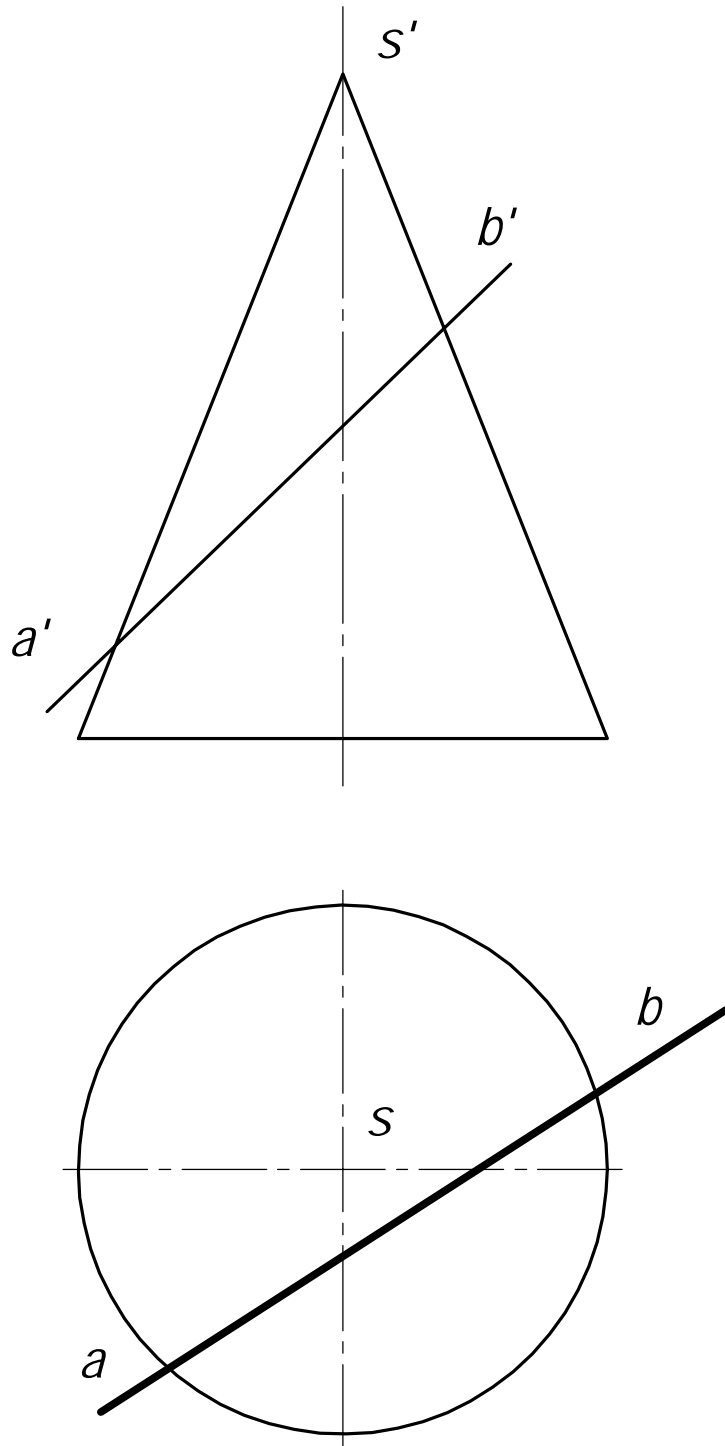

Ìîâ. è ãàà	Èíà. 1 ãààè	Áçáí. èíà. 1	Ìîâ. è ãàà	Èíà. 1 ìíàè
------------	-------------	--------------	------------	-------------

Ëçì.	Èèñò	1 àíèóì.	Ìîâ.	Áààà
------	------	----------	------	------

Ì ÆÒÏ Æ ÆÑÌ Ï Ï Ï ÆÀÒ ÆÛÌ ÕÕ ÑÆÓ ÕÈÕ
Ì ÈÏ ÑÈÏ ÑÒÆ

Àèãîðèòì

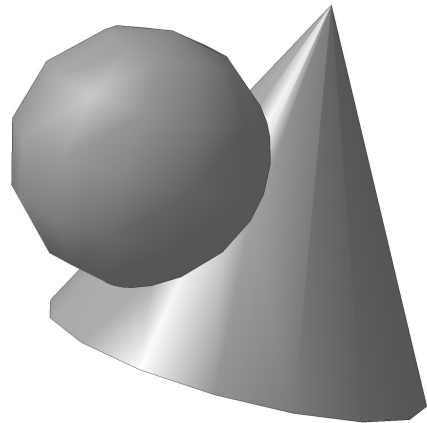

Èíá ¹ ìîâè.	Ìîâì. è ààòá	Æçàì. èíá ¹	Èíá ¹ áðæè.	Ìîâì. è ààòá
Èçì. Èèò	¹ áñèòì.	Ìîâì.	Æàòá	

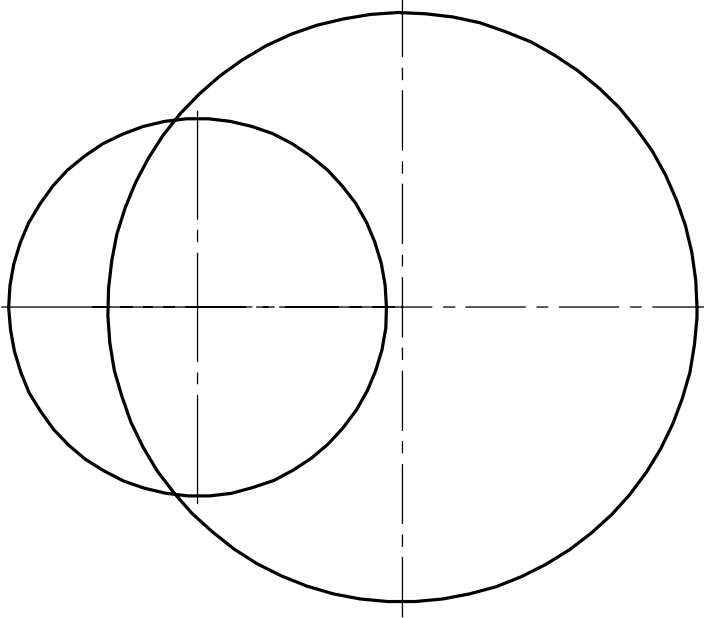
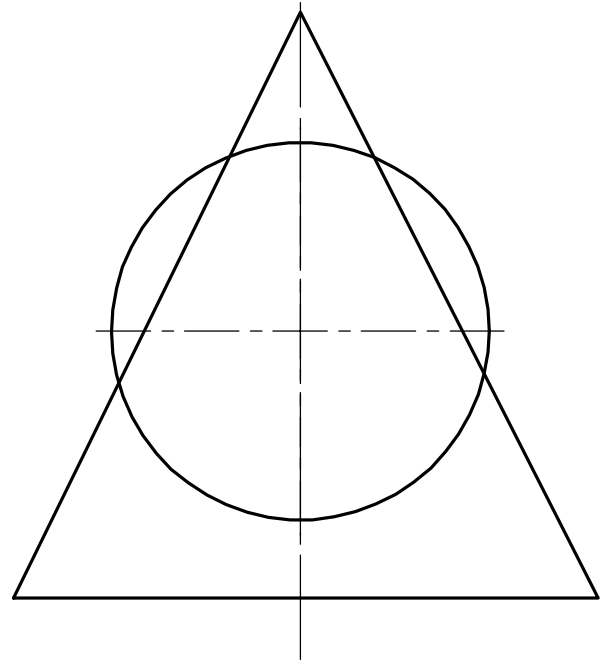
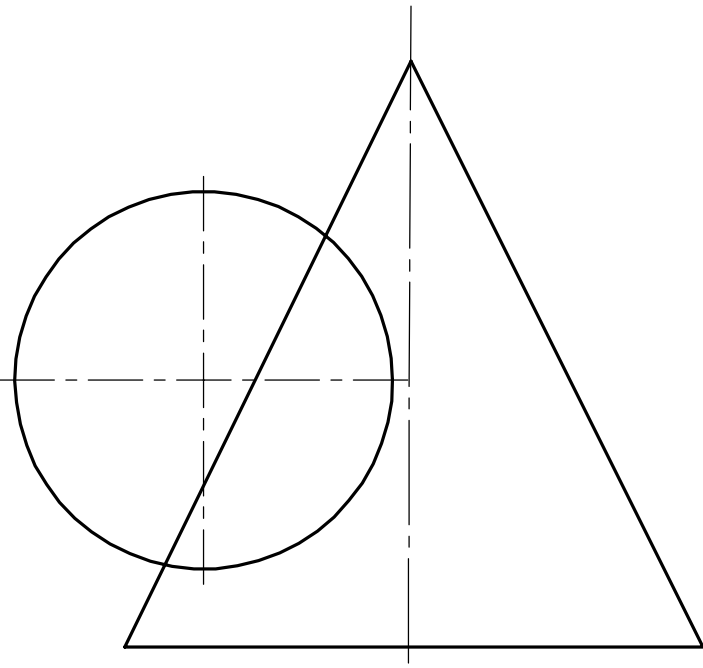

Ìîâí. è ãàòà	Èíà. 1 ãàòè	Áçàí. èíà. 1	Ìîâí. è ãàòà	Èíà. 1 Ìîâí.
--------------	-------------	--------------	--------------	--------------

Èçì.	Èèñò	1 àíèóí.	Ìîâí.	Áàòà
------	------	----------	-------	------

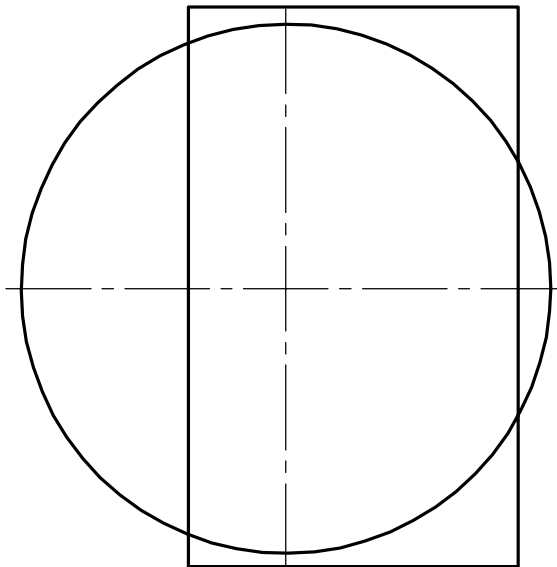
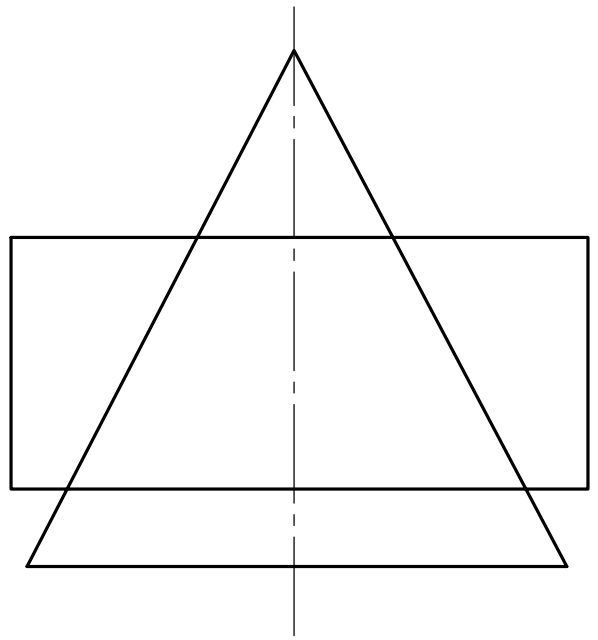
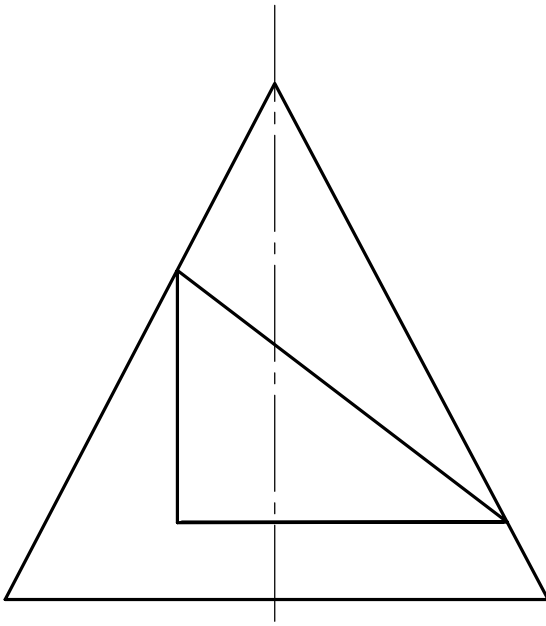
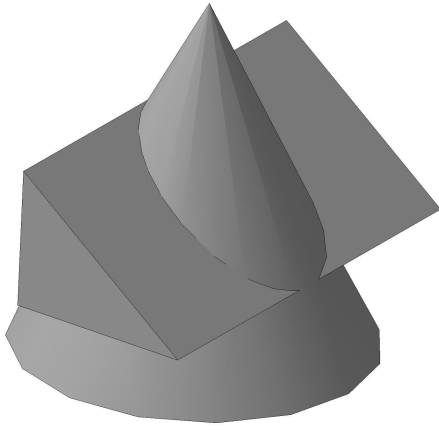

Êíá 1 ìíáè.	Ìíáí: è áàðá	Êíá 1 áðáé.	Ìíáí: è áàðá
Êçì. Êèñð	1 áíèóí.	Ìíáí.	Áàðá

Ì ÁÒÎ Á ÑÃÊÓÙÈÕ ÑÔÃÐ

Ñíîñîá ñãêóùèõ ñôãð ñ ïîñòíýííùì òáíððî ãëý
ïîñòðîáíèý èeíèè ïãðñãá=áíèý äãóó ïîáãðõíîñè
íðèì áíýðò ïðè ñèããóðùèõ óñèíáèýõ

1)

2)

3)

Ãëãîðèòì

Íîá. è äãòá
Ëíá. 1 äãè
Ãçáí. èíá. 1
Íîá. è äãòá
Ëíá. 1 ïñãè

Ëçì.	Ëèòò	¹ äíèóì.	Íîáí.	Ãòà
------	------	---------------------	-------	-----

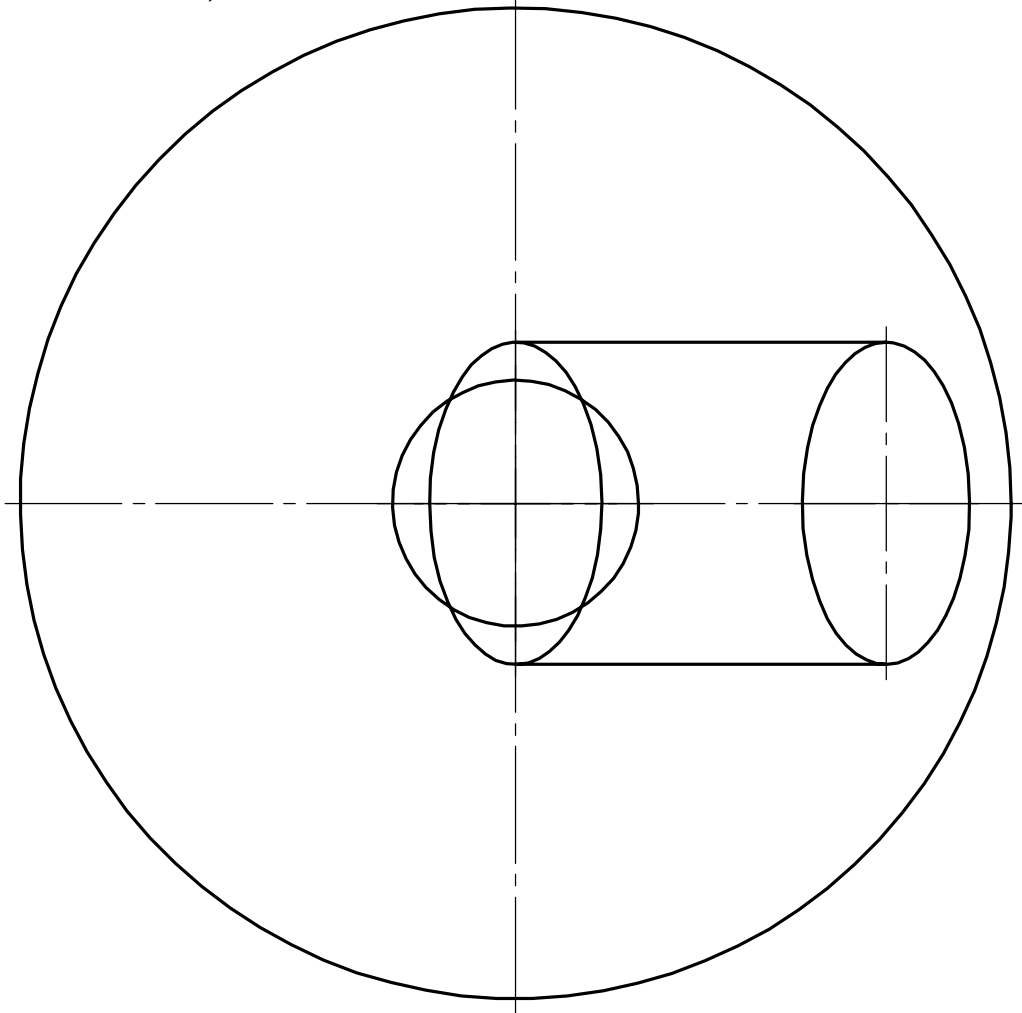
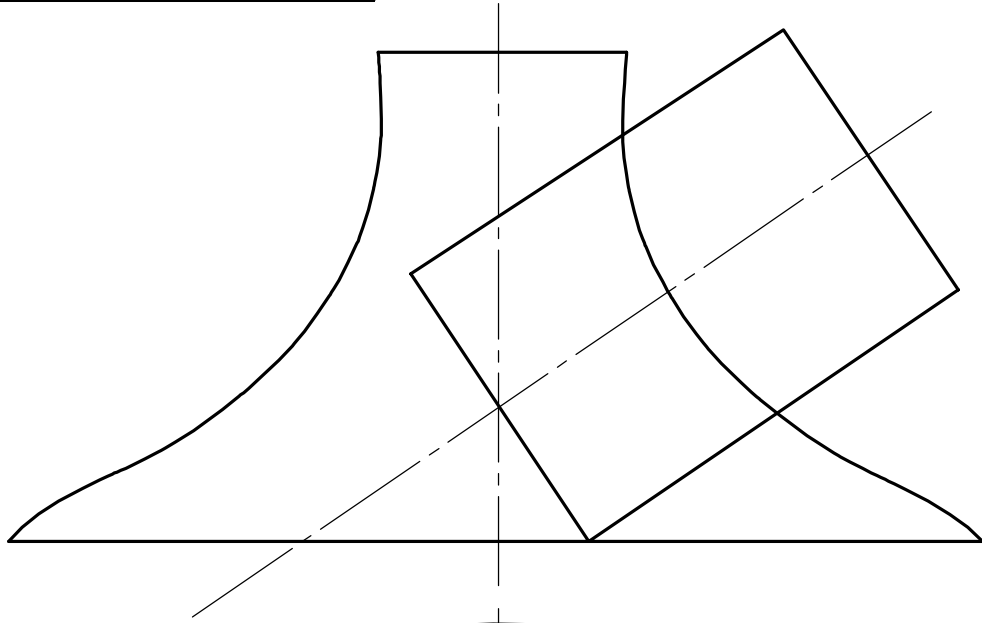

Êíá 1 ìîâè.	Ìîâí: è ààðà	Áçàì. èíá 1	Êíá 1 àðàé.	Ìîâí: è ààðà
Êçì. Êèñò	1 àíèòì.	Ìîâí.	Ààðà	

×ΑΝΟΙΟΥ ΝΕΟ×ΑΕ ΙΑΔΑΝΑ×ΑΙΕΒ ΙΤΑΑΔΟΙΤΝΟΑΕ
ΑΟΙΘΙΑΙ ΙΤΘΒΑΕΑ

Ìîååðõíîè ð åòíðíáí ïîðÿæà íàçõååðñÿ

Áåå ïîååðõíîè åòíðíáí ïîðÿæà á íáõåí ñåó÷åå.

Θαίθαί à 1.

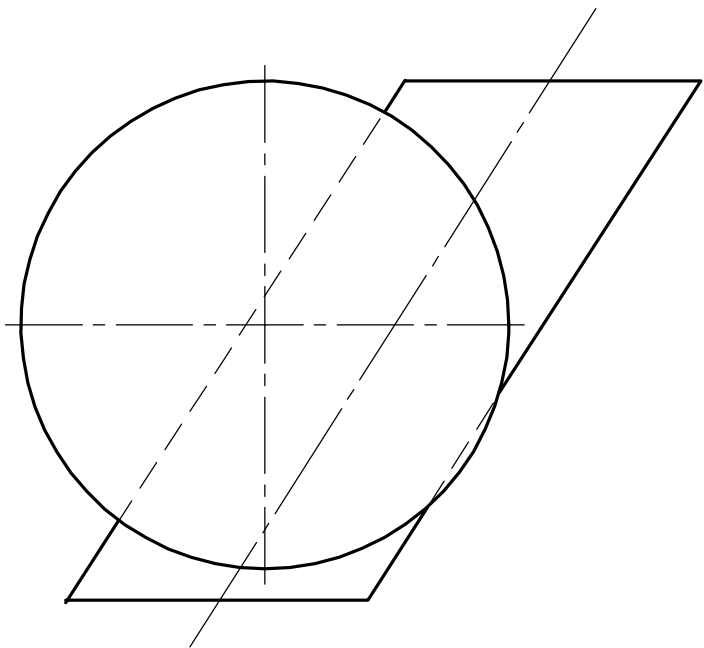
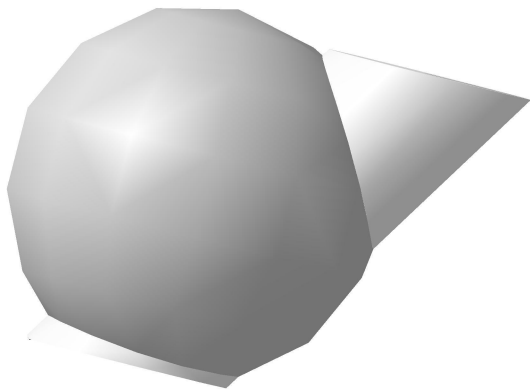

Ìîåí. è ååå
Êí. 1 ååè
Áçåí. èí. 1
Ìîåí. è ååå
Êí. 1 ïíæ

Êçí.	Êèð	1 áíåóí.	Ìîåí.	Áåå
------	-----	----------	-------	-----

Òâîðâî à 2

Òâîðâî à 2. (î äâîéíî èàñàíèè)

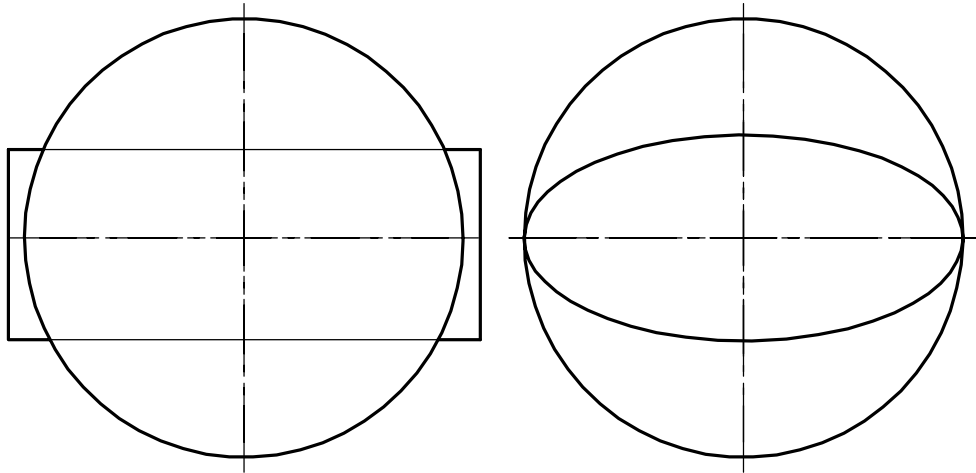
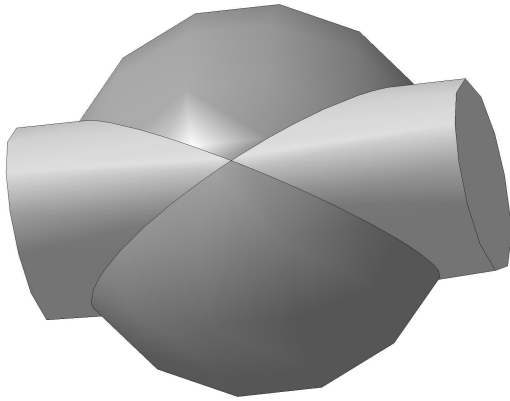

Êíá 1 ìîâè.	Ìîâî: è ààðà	Àçàì. èíá 1	Êíá 1 àðé.	Ìîâî: è ààðà
Êçì. Êèò	1 àíèòì.	Ìîâî.	Ààðà	

Òáîðáì à Ìîíæà

Òáîðáì à 3. (Òáîðáì à Æ. Ìîíæà).

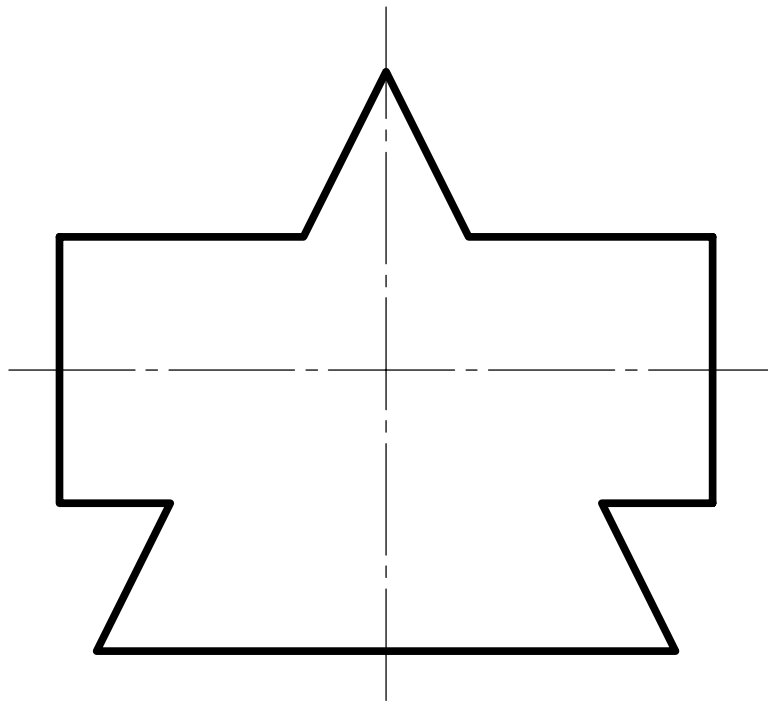
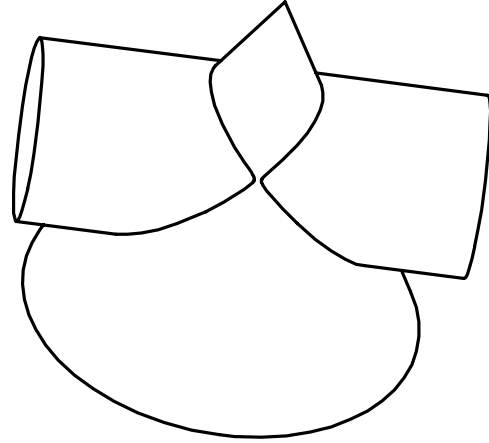
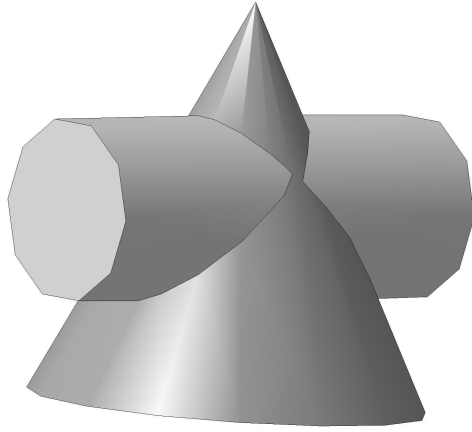

Ìîí. è ãàòà	Ëíà. 1 ãàòè	Æçì. èíà. 1	Ìîí. è ãàòà	Ëíà. 1 ìíæè
-------------	-------------	-------------	-------------	-------------

Ëçì.	Ëèòò	1 àíeóì.	Ìîí.	Æàòà
------	------	----------	------	------

l l i a i a d a l i e e l i i a c u a a o n y -

A e u l l i a i a d a l i e e l a

l e d a i e a a -

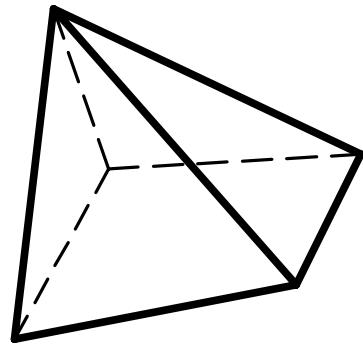
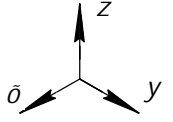

Y i p d

E i a l i a e	l l i a i e a a a	A a l e i a l	E i a l a a e	l l i a i e a a a	

E i l	E e n o	l a i e o i	l l i a i	A a a a
-------	---------	-------------	-----------	---------

Ì í î ã î ã ð à í í è è è

Ì ð è ç ì à ò î è ä

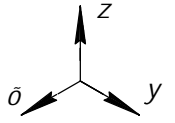

À è ñ ï ï ï à ò ð è ÿ

ÿ ï ð ð

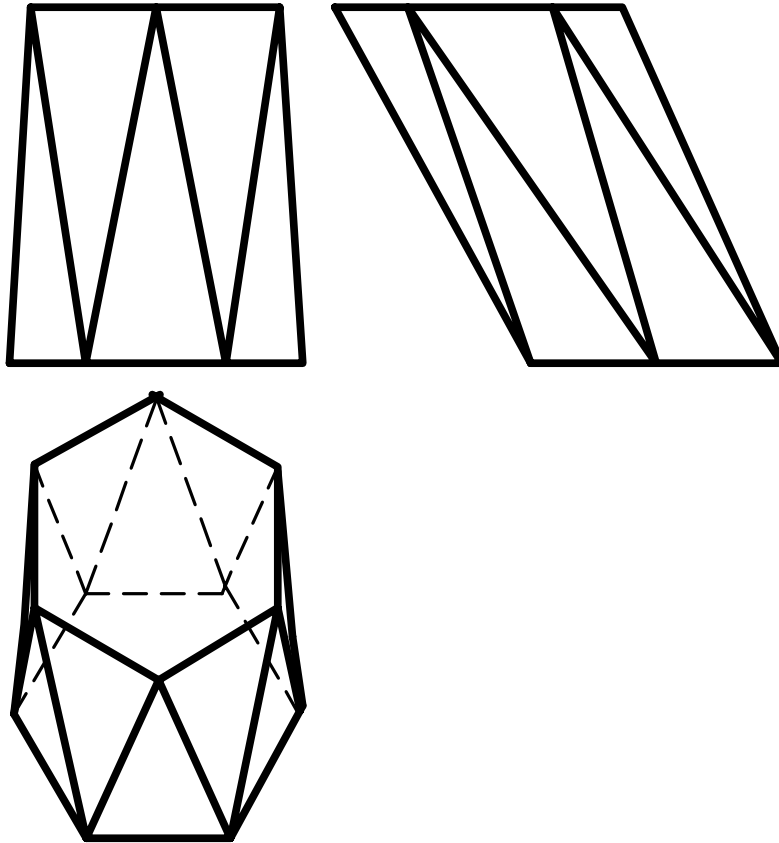

È í á 1 ï ï à è.	Ì í î ã ì è ä ò à	À ç à ì. è í á. 1	È í á. 1 à ò à è.	Ì í î ã ì è ä ò à
È ç ì. È è ñ ò	1 à ï è ò ì.	Ì í î ã ì.	À à ò à	

È ç ì.	È è ñ ò	1 à ï è ò ì.	Ì í î ã ì.	À à ò à
--------	---------	--------------	------------	---------

Ì í î ã î ã ð à í í è è è

È è ñ ò
3

Ì í î ã ã ð à í í è è è

Î ê ò à ý ä ð

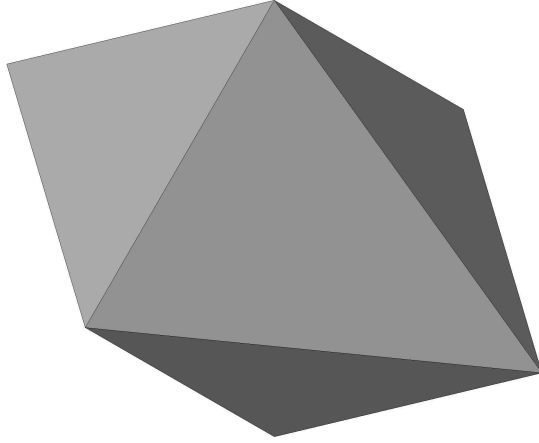
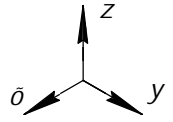

Ý í ð ð

Ì í î ã ã ð à í í è è è
È ì à ¹ ä à ð è
À ç à ì. è ì à. ¹
Ì í î ã ã ð à í í è è è
È ì à. ¹ ì ã è

È ç ì.	È è ñ ò	¹ ä ã è ó ì.	Ì í î ã ã ð à í í è è è	À à ò à
--------	---------	--------------	-------------------------	---------

È è ñ ò
6

Ì Í Î Ñ Ñ Ñ Ñ Ñ Ñ Ñ Ñ

Äî äãêàýäð

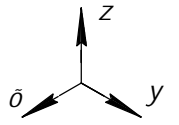

Äî äãêàýäð

Ýì þð

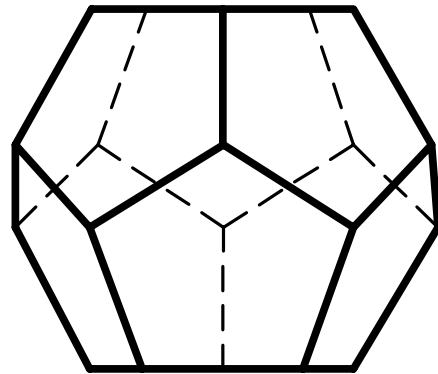
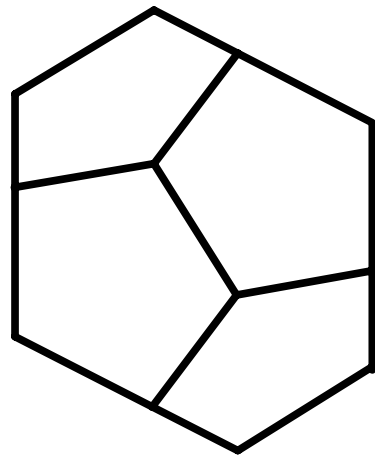
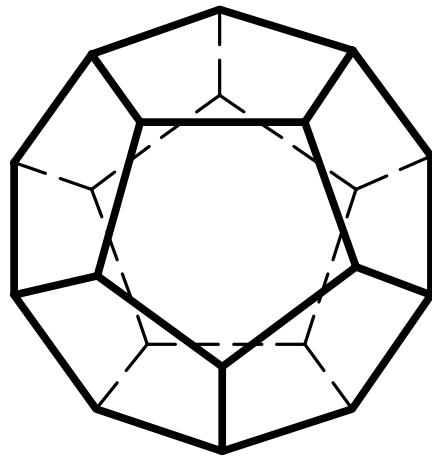

Éía ¹ ìñäé.	Ìñái. é äððä	Àçái. é íá. ¹	Éía ¹ äððé.	Ìñái. é äððä
Éçì. Èéñð	¹ äñéõì.	Ìñái.	Ääðä	

Éçì.	Èéñð	¹ äñéõì.	Ìñái.	Ääðä
------	------	----------	-------	------

Ì Í Î Ñ Ñ Ñ Ñ Ñ Ñ Ñ Ñ

Èéñð
7

ἔἔἔ ἰ ἰῖῖ ἰῖῖ ἰῖῖ ἰῖῖ ἰῖῖ

Èêî ñàýäð

Ñîñòîèò èç..

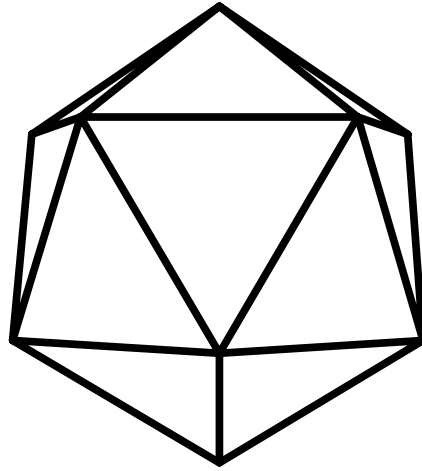
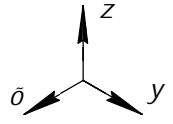

Èêî ñàýäð

Ýìþð

ἰῖῖ. è ἄἄἄ
Èἰἰ. ἰ ἄἄἄ
Ἀῖἰ. èἰἰ. ἰ
ἰῖῖ. è ἄἄἄ
Èἰἰ. ἰ ῖῖῖ

Èçì.	Èèñò	ἰ ἄῖῖῖ.	ἰῖῖ.	Ἀἄἄ
------	------	---------	------	-----

ἰ ἰῖ ἄἰ ἄῖἰ ἰῖῖῖ

Èèñò
8

Ì Í Î Ã Î Ã ĐÀ Í Í È È È

Çâåçä÷àòùå ôîðî ù è ñîåäèáíèÿ
òåë Ìèàòîíà

Đaññî àòðèààÿ ìããñã÷áíèÿ ìðíãíëæáíèÿ ãðáíáé
Ìèàòîííáúô òåë, ì ù áóää ìíèó÷àòü
çâåçä÷àòùå ì Ì Î Ã Î Ã ĐÀ Í Í È È È

Éíá ¹ ìíáé.	Íîíí. è åàòà	Áçãí. èíá. ¹	Éíá. ¹ áóáé.	Íîíí. è åàòà
Éçí.	Èéòò	¹ áíèóí.	Íîíí.	Áàòà

Ì Í Î Ã Î Ã ĐÀ Í Í È È È

ËËË Ì ÌËË ÌË Ì Ì

Çââçä÷àòùé îêòàýäð

âîñàì ü ìãñãèàþùèõñý ìëîñêîñàé äðàíáé
 îêòàýäðà îääëýðò...

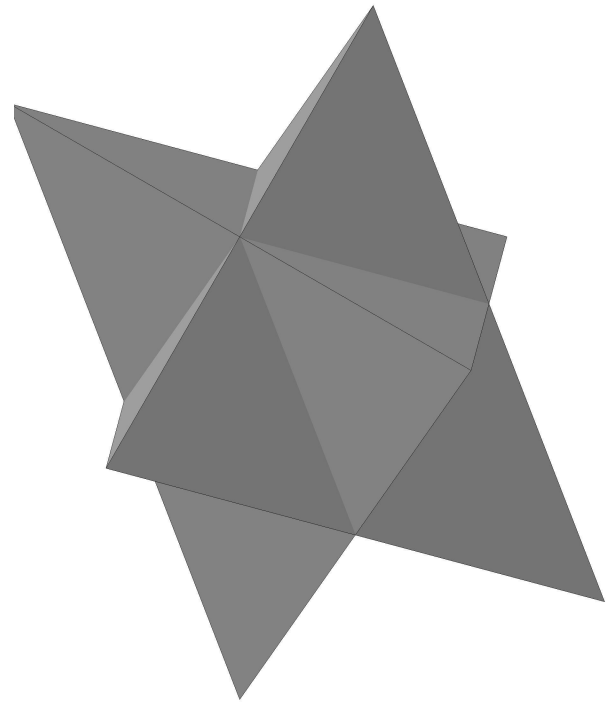
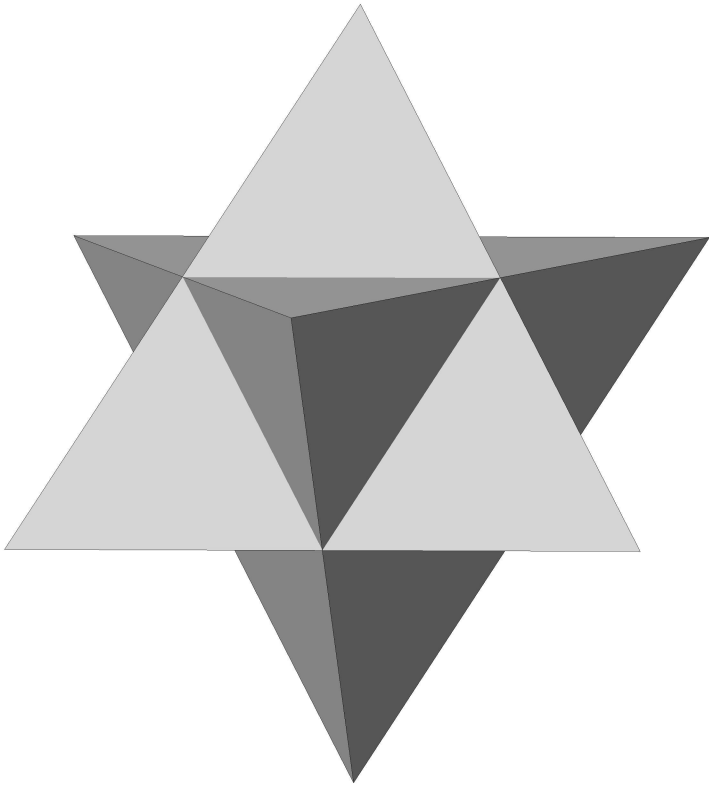
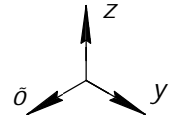

Çââçä÷àòùé îêòàýäð

Ïäï. è äàà	Èä. 1 äàè	Ãçàí. èíä. 1	Ïäï. è äàà	Èä. 1 ïäè
------------	-----------	--------------	------------	-----------

Ëçì.	Èèòò	1 äñèòì.	Ïäï.	Ãàà
------	------	----------	------	-----

Ì Ì Ì Ì Ì Ì Ì Ì

ÀÈÑÎÍÎÎ ÀÒÐÈ×ÁÑÈÈÁ ÌÐÎÁÈÖÈÈ

Ñóííñòü àèñîíîî àòðè÷áñèèò ìðîáèöèè

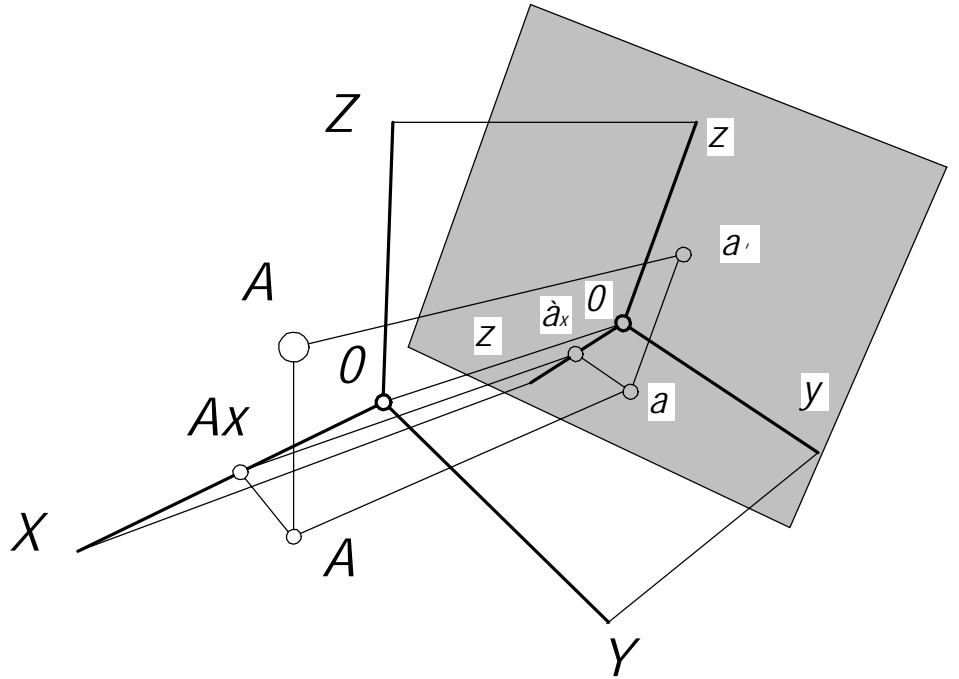

îðîáîîî àèñîíîî ìðîáèöèè òî÷èè

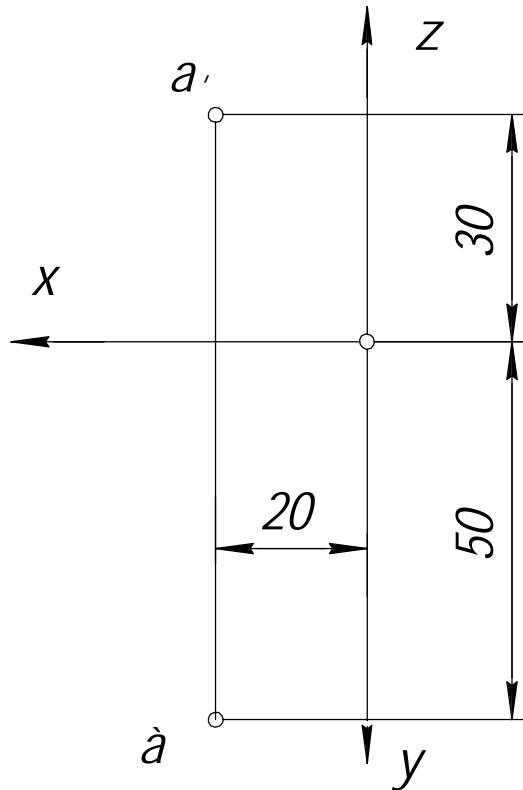

Èíá 1 ìñàè.	Ìñàè. è ààòá	Àçàì. èíá 1	Èíá 1 àòðè.	Ìñàè. è ààòá
Èçì. Èèò	1 àñèò.	Ìñàè.	Ààòá	

èçî ì ãòðè÷ãñêà ìðìàèè òî÷èè

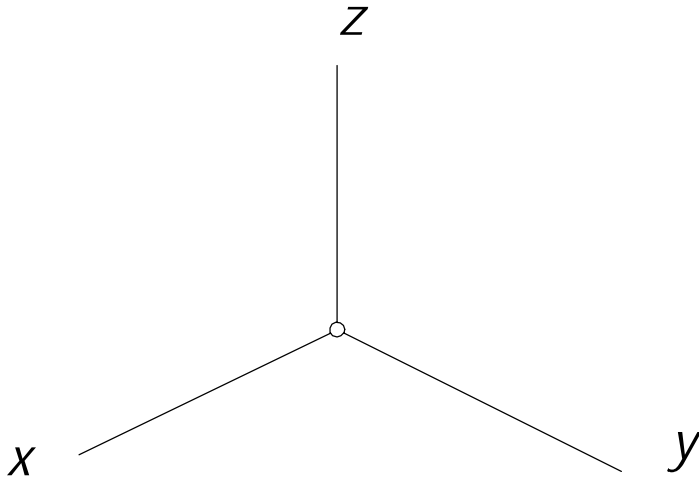

äèì ãòðè÷ãñêà ìðìàèè òî÷èè

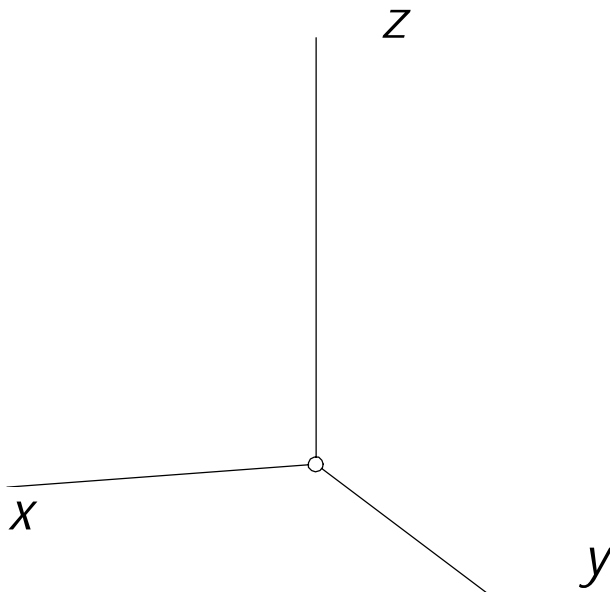

Ìñì. è ãàà	Èñ. 1 ãàè	Àçì. èñ. 1	Ìñì. è ãàà	Èñ. 1 ìñè
------------	-----------	------------	------------	-----------

Èçì.	Èèò	¹ äñèîì.	Ìñì.	Ààà
------	-----	---------------------	------	-----

Àèñîíî ãòðè÷ãñêà ìðìàèè

Èèò
2

ÀÊÑÎÍÎÌ ÀÒÐÈ×ÃÑÊÈÁ ÌÐÎ ÆËÏÈÈ

Àèäü àêñîíîì àòðè÷ãñêèõ ìðî æëïèé

ìðÿì îóãîëüíûá -

êîñîóãîëüíûá -

êîÿôèèèáíò èñêàæáíèÿ -

èçîì àòðè÷ãñêèá -

äèì àòðè÷ãñêèá -

òðèì àòðè÷ãñêèá -

Èíá ¹ ìñáé.	Íñáì. è ààòá	Àçãì. èíá. ¹	Èíá. ¹ áòáé.	Íñáì. è ààòá
Èçì.	Èèòò	¹ áñèòì.	Íñáì.	Ààòá

Àêñîíîì àòðè÷ãñêèá ìðî æëïèé

Îñîáîíàÿ òáîðàè à àèñîíîìè áòðèè (Òáîðàè à ÌËËË)

Ðàññè îððåâ ïáóèå ñåååáèèÿ ïá àèñîíîìè áòðè÷áñêèè
ìðîáèèèè, ìîáèè ñååèòü ñååóòèè àóâèó:

- 1.
- 2.

Òáîðàè à àèñîíîìè áòðèè -

Ñòàíäàðòîíà àèñîíîìè áòðè÷áñêèè ìðîáèèèè

Ìñî. è áòà
Ëñ. 1 áòà
Àñî. èñ. 1
Ìñî. è áòà
Ëñ. 1 ìñî.

Ëñ.	Ëèò	1 áñèè.	Ìñî.	Áòà	Àèñîíîìè áòðè÷áñêèè ìðîáèèèè	Ëèò
						4

ðàñîîêîæáííûõ â ïàðàèèáüíûõ ïèññèñòîÿõ îðîáêöèè

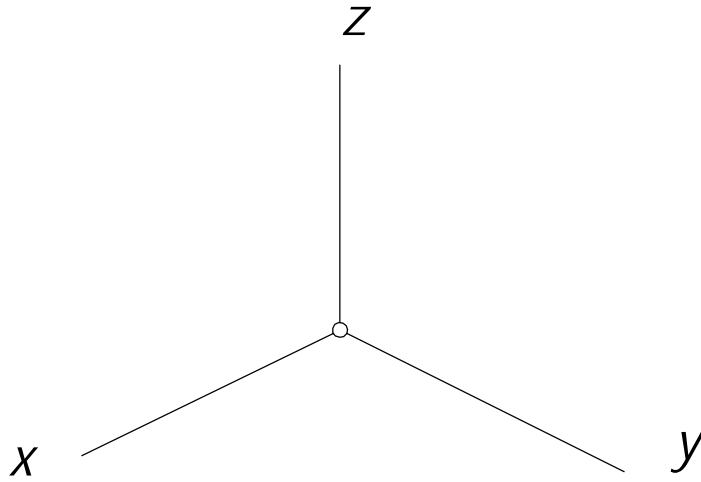

íîñòðîáíèá îêðóæíîñòè â ïðÿìîóãîíèêè èçîìåòðèè

Éíá 1 îñáé.	Íñáí. è áàðá	Áçáí. èíá 1	Éíá 1 áðáé.	Íñáí. è áàðá
Éçì.	Èèòò	1 áñêèá.	Íñáí.	Áàðá

Ãðàòè÷ãñêèå ìîñòðîíèå, ìðååðãñòàòèèå àó÷ð÷èåìèè
ñàììè ÿèèèíà, òåãñîíèãðàçì àóììèéòó à ñèååòèè
ìîñòðîíèå àòèèìèè:

- 1.
- 2.
- 3.
- 4.

Ìîñòðîíèå àèñîíèìè àòèèìèè
èçìèãðàçìèè

ÌÎÑÒÐÎÍÈÅ ÆÑÎÍÈÌÈ ÀÒÈÈÌÈÈ ÆÇÌÈÃÐÀÇÌÈÈ
Ìðååòèè ìîñòðîíèåìè ìðååòèè ìðååòèè
àèñîíèìè àòèèìèè èçìèìèè ðåèìè àìèèè
ìîñòðîíèå àòèèìèè ìîñòðîíèå :

Ìì. è àòà
Èì. 1 àòà
Àçì. èì. 1
Ìì. è àòà
Èì. 1 ììè

Èçì.	Èèò	1 àèèì.	Ìì.	Àòà
------	-----	---------	-----	-----

Èíà 1 ìñàè.	Ìñàì. è ààðà	Àçàì. èíà 1	Èíà 1 àòðè.	Ìñàì. è ààðà
Èçì. Èèò	1 àñêòì.	Ìñàì.	Ààðà	

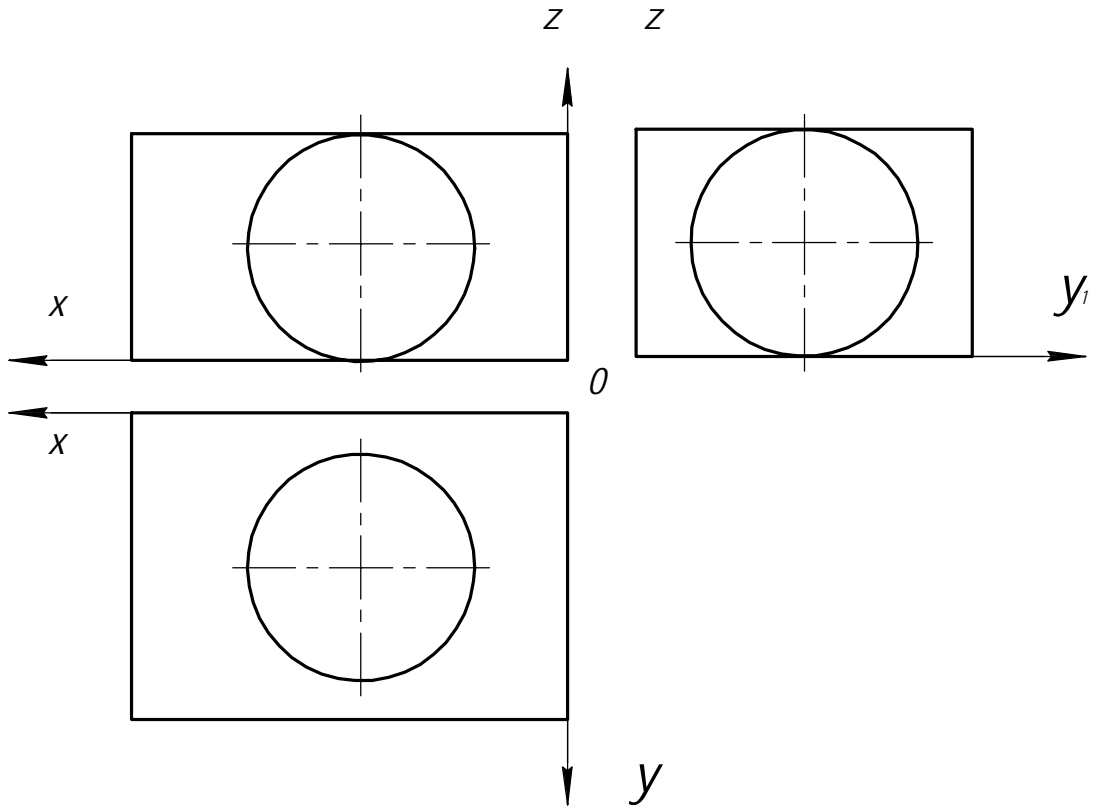

Àèñîíîì áòðè:áñêèá ìðîáèöèè

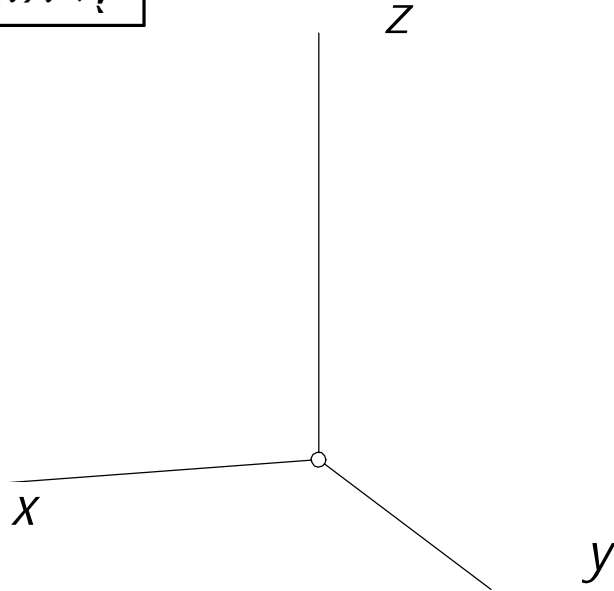

Ìîñòðîáíèá îêðáíîñè á ìðÿì îóáîüîíé àèì áòðèè

Ìñì. è áàòà	Èò. 1 áàò.	Áçì. èò. 1	Ìñì. è áàòà	Èò. 1 ìñè
-------------	------------	------------	-------------	-----------

Èçì.	Èèò	1 áñèóì.	Ìñì.	Áàòà
------	-----	----------	------	------

Àèñîíîì áòðè:áñêèá ìðîáèöèè

Èèò
8

Éíà 1 ïîáè.	Ïîáè: è ààðà	Àçàì. èíá 1	Éíà 1 àòðè.	Ïîáè: è ààðà
Éçì. Èèò	1 àñèò.	Ïîáè.	Ààðà	

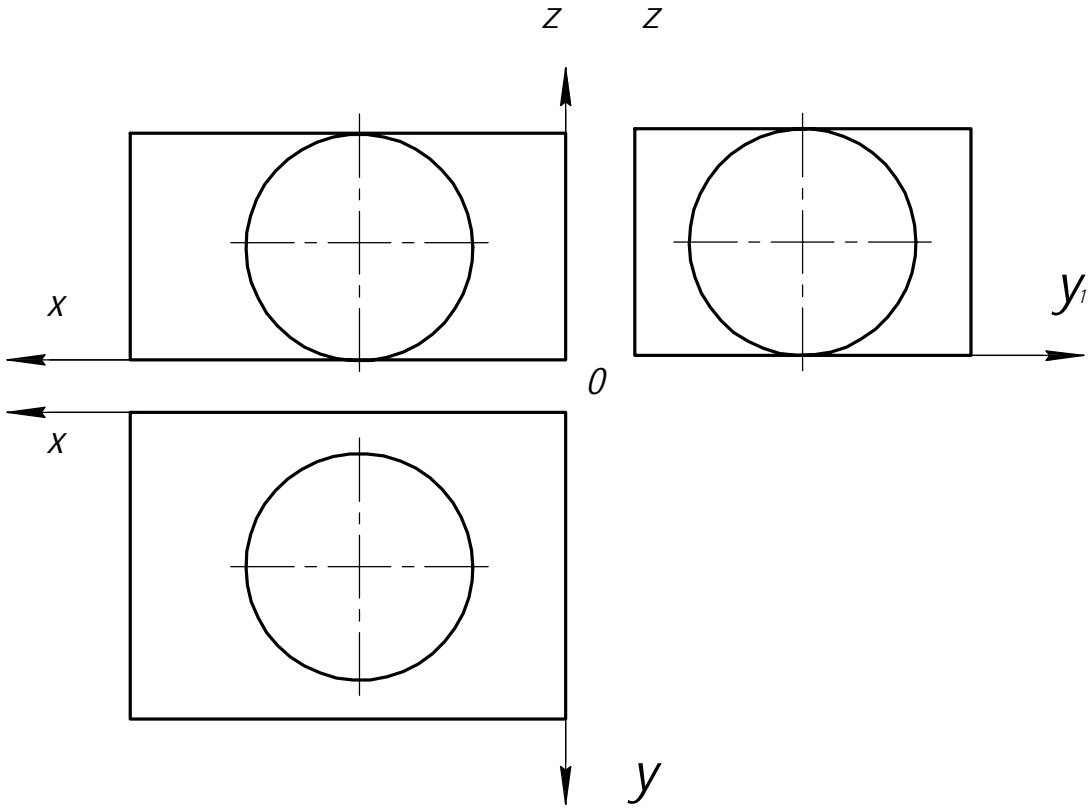

Ìðèì áð ìîñòðìáíèÿ èçìáðàæáíèÿ á
ìðÿì îóáìèüíìé èçììáòðèè. Øòðèîìáèà ðàçðáçìá

Ìðèì áð ìîñòðìáíèÿ èçìáðàæáíèÿ á
ìðÿì îóáìèüíìé áèì áòðèè. Øòðèîìáèà ðàçðáçìá

Ìñì. è áàòà
Èìá. 1 áàòè
Áçìì. èìá. 1
Ìñì. è áàòà
Èìá. 1 ìñìè

Èçì.	Èèñò	¹ áñèóì.	Ìñì.	Áàòà
------	------	---------------------	------	------

Áúáîð àèää àêñîíîì áòðè÷:áñêéè í ðîì áêöèè

*Ìîñëääî ààðäëüíîñòü è ðèàì ù ìîñòîìáíèý
àêñîíîì áòðè÷:áñêéè í ðîì áêöèè*

<i>Ìîì ìîì.</i>	<i>Ìîì. è ààðä</i>	<i>Àçàì. èíá. 1</i>	<i>Èíá. 1 áòðè.</i>	<i>Ìîì. è ààðä</i>
<i>Èíá. 1 ìîì.</i>				
<i>Èçì. Èèò</i>	<i>1 àñêîì.</i>	<i>Ìîì.</i>	<i>Ààðä</i>	

Àêñîíîì áòðè÷:áñêéè á ðîì áêöèè

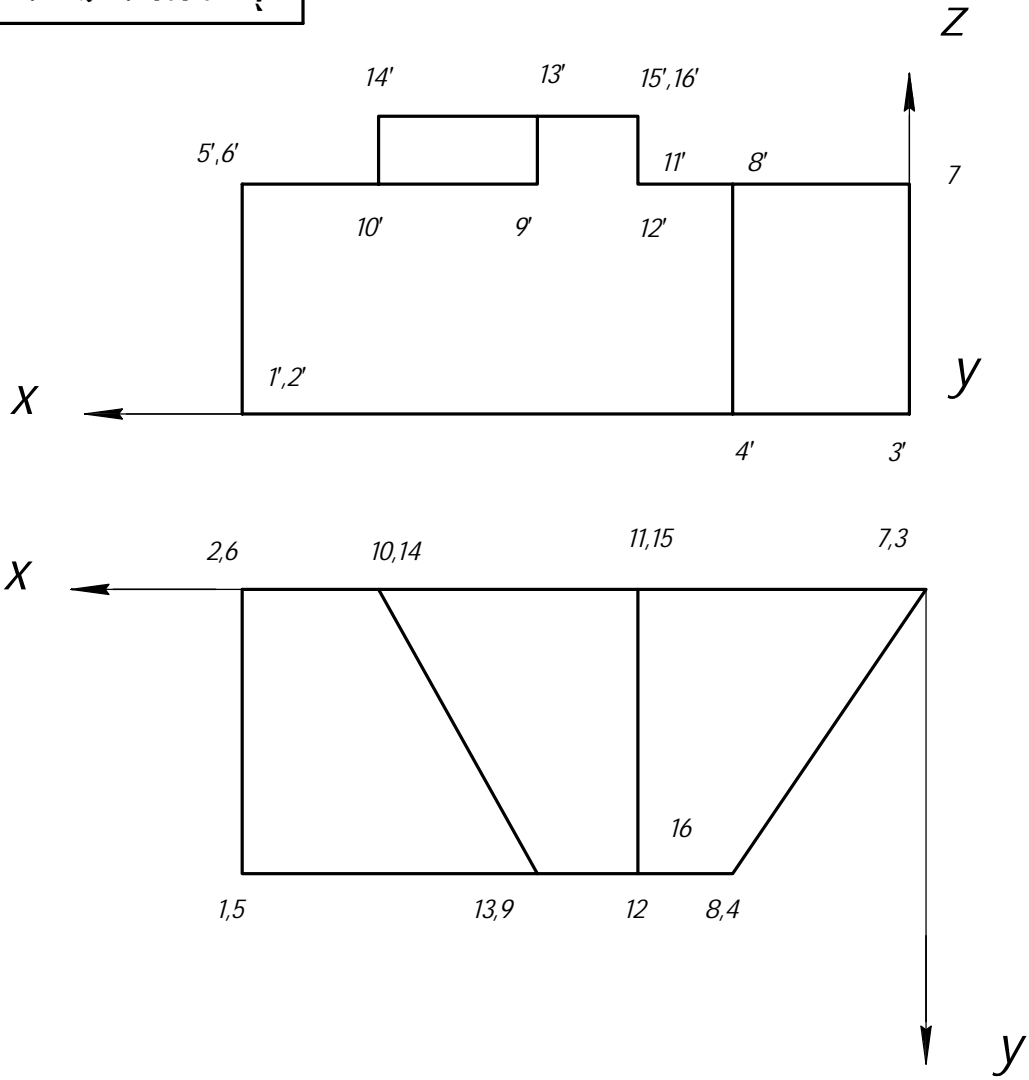

Ìñî. è ààÒà	Èñ. 1 ààè	Àçò. èñ. 1	Ìñî. è ààÒà	Èñ. 1 ïñè
-------------	-----------	------------	-------------	-----------

Èçì.	Èèò	1 àñéòì.	Ìñî.	Ààòà
------	-----	----------	------	------

Àêñîíîì àòðè: àñêèà ìðî àêöèè

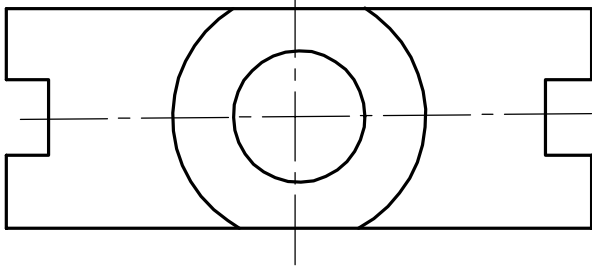
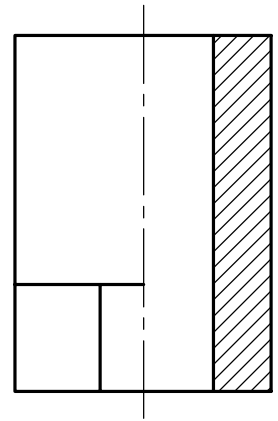
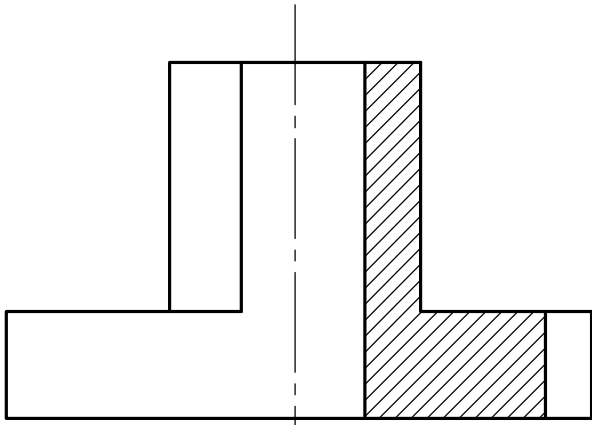

Éíà ¹ ìñáè.	Ìñáì: è ààðà	Áçàì. èíá ¹	Éíà ¹ àðáè.	Ìñáì: è ààðà
Éçì.	Èèòò	¹ àñêòì.	Ìñáì.	Áàðà

Àêñîíîì àòðè: àñêèà ìðî àêöèè

Ἰῆὸδῆ ἄε δὰçáâðòíê ἰῆâðõíῆðáé

Ἐὰçáâðòéà -

Ἐὰçáâðòúâàðùèáñÿ ἰῆâðõíῆðè -

*Ἐὰçá, ðòéè ἰῆâðõíῆðáé ἰάèääàðò
ñèääòðùèì è ñâí éñòâàì è:*

1.

2.

3.

4.

5.

Ἐèàññèòèèàöèÿ δὰçáâðòíê ἰῆâðõíῆðáé

Ἐὰçáâðòéè ἰῆâðõíῆðáé ääèÿòñÿ ἰά:

òí ÷ ἰúâ -

Ἰῆì. è äàòà
Ἐῖà. 1 äàè.
Ἄçâì. èῖà. 1
Ἰῆì. è äàòà
Ἐῖà. 1 ἰῆäè

					<i>Ἐὰçáâðòéè ἰῆâðõíῆðáé</i>	Ἐèò
Ἐçì.	Ἐèò	¹ äῖéóì.	Ἰῆì.	Ἀàðà		1

ìđèáèèæáííúá -

òñêîáíúá -

*Íîñòđîáíèá òî÷íúõ đàçáãđòîê
ìíîãîãđàííèêîá*

*Äëÿ ìîñòđîáíèÿ đàçáãđòîê ìíîãîãđàííèêîá
ìđèìáíÿòñÿ ñèããóòòèá ñìîñîáú:*

*Íîđî àèüíîãî ñã÷áíèÿ -
đàñèàðèè -
òđèàíãóèÿöèè (òđãóãîèüíèêîá) -*

Ñìîñîá íîđî àèüíîãî ñã÷áíèÿ

Ñóùíîñòü ñìîñîáà íîđî àèüíîãî ñã÷áíèÿ -

<i>Íîđî àèüíîãî ñã÷áíèÿ</i>	<i>Íîđî àèüíîãî ñã÷áíèÿ</i>	<i>Íîđî àèüíîãî ñã÷áíèÿ</i>	<i>Íîđî àèüíîãî ñã÷áíèÿ</i>	<i>Íîđî àèüíîãî ñã÷áíèÿ</i>
<i>Íîđî àèüíîãî ñã÷áíèÿ</i>	<i>Íîđî àèüíîãî ñã÷áíèÿ</i>	<i>Íîđî àèüíîãî ñã÷áíèÿ</i>	<i>Íîđî àèüíîãî ñã÷áíèÿ</i>	<i>Íîđî àèüíîãî ñã÷áíèÿ</i>
<i>Íîđî àèüíîãî ñã÷áíèÿ</i>	<i>Íîđî àèüíîãî ñã÷áíèÿ</i>	<i>Íîđî àèüíîãî ñã÷áíèÿ</i>	<i>Íîđî àèüíîãî ñã÷áíèÿ</i>	<i>Íîđî àèüíîãî ñã÷áíèÿ</i>
<i>Íîđî àèüíîãî ñã÷áíèÿ</i>	<i>Íîđî àèüíîãî ñã÷áíèÿ</i>	<i>Íîđî àèüíîãî ñã÷áíèÿ</i>	<i>Íîđî àèüíîãî ñã÷áíèÿ</i>	<i>Íîđî àèüíîãî ñã÷áíèÿ</i>

Đàçããðòêê ìîâãðõíîñàé

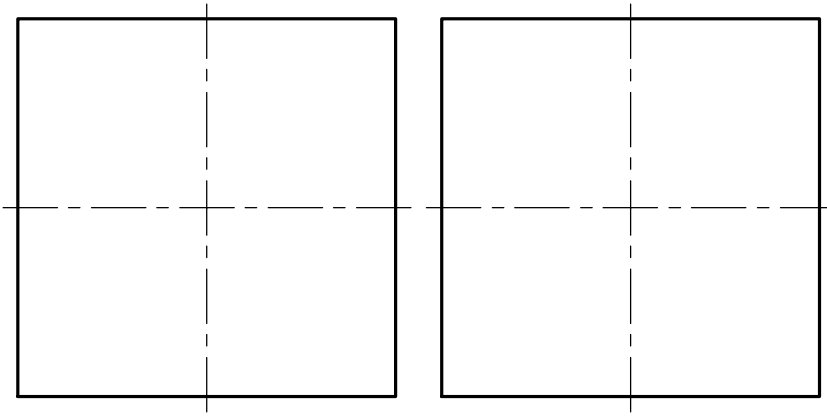

Ìřãí. è ããÒà	Èřã. 1 ãããé	Ãçãí. èřã. 1	Ìřãí. è ããÒà	Èřã. 1 ìřãé
--------------	-------------	--------------	--------------	-------------

Èçì.	Èèñò	¹ ãřéóì.	Ìřãí.	Ããòà
------	------	---------------------	-------	------

Đàçããðòêê ìîâãðõíîñàé

Èèñò
3

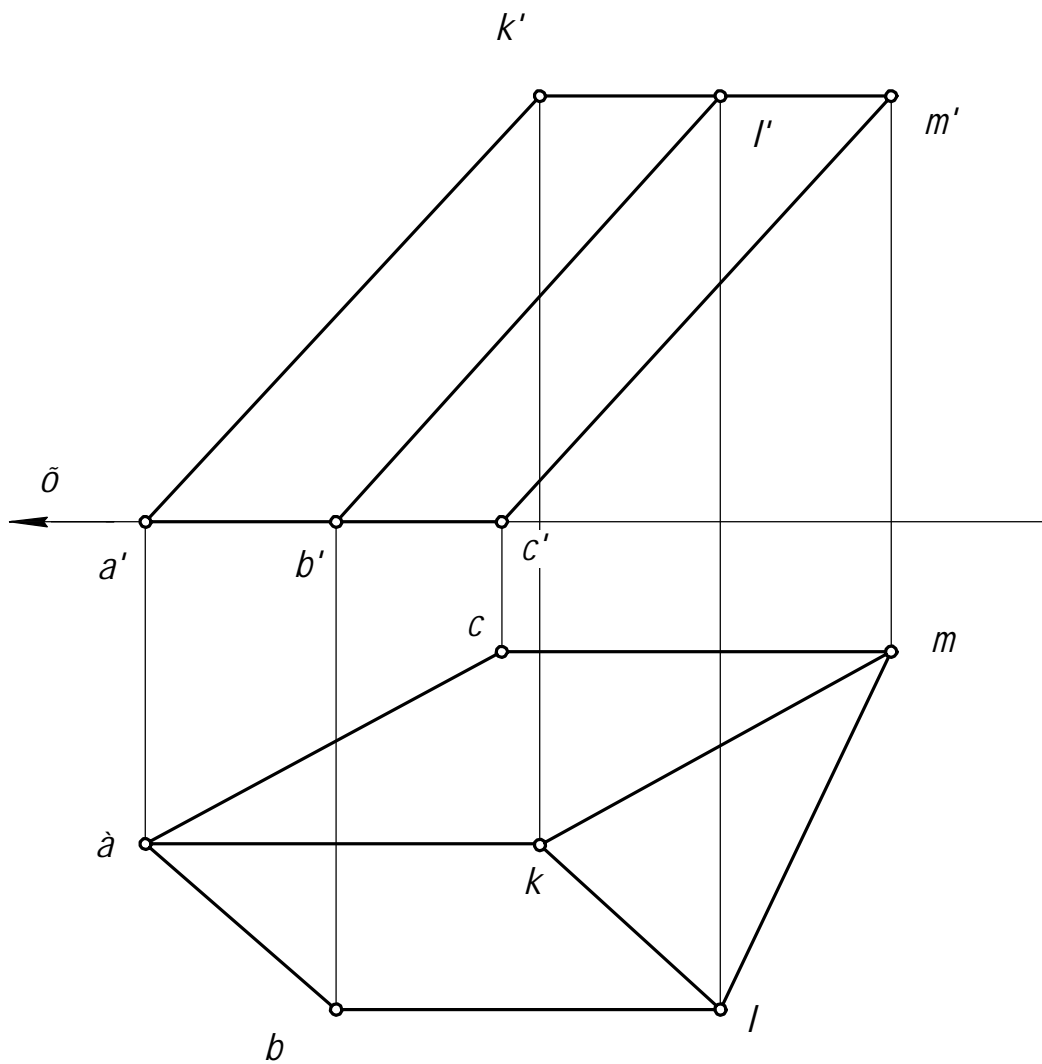

Éîá 1 îîâé.	Îîâî: é âàðà	Áçàî. éîá 1	Éîá 1 áðáé.	Îîâî: é âàðà
Éçì.	Éêñð	1 áîéòî.	Îîâî.	Áàðà

Ἐπιτομή ἰσχυρῶν

Ἰῆ. ἔ. ἀαὸ

Ἐῖ. ἰ. ἀαὸ

Ἀαῖ. εῖ. ἰ

Ἰῆ. ἔ. ἀαὸ

Ἐῖ. ἰ. ῖ. ἔ.

Ἐπιτομή ἰσχυρῶν

Ἐῖ. ἰ. ῖ. ἔ.
5

Ἐῖ. Ἐῖ. ἰ.

ἰ. ἰ. ἰ.

Ἰῆ.

Ἀαὸ

Ñîîñîá òḑèáíãóëÿöèè (òḑãóãîëüíèêîâ)

Ñóùíîñòü ñîîñîáà òḑèáíãóëÿöèè -

Îîñòḑîáíèá ìà ḑaçããḑòèá òî÷èè èãæàùáé ìà ìîâãḑõíîñòè ìèḑàì èäü:

Éíá ¹ ìîâé.	Îîñîáí. è ààḑà	Áçãî. è íá. ¹	Éíá. ¹ áóáé.	Îîñîáí. è ààḑà
Éçì. Èèñò	¹ áîéõî.	Îîñîáí.	Áàḑà	

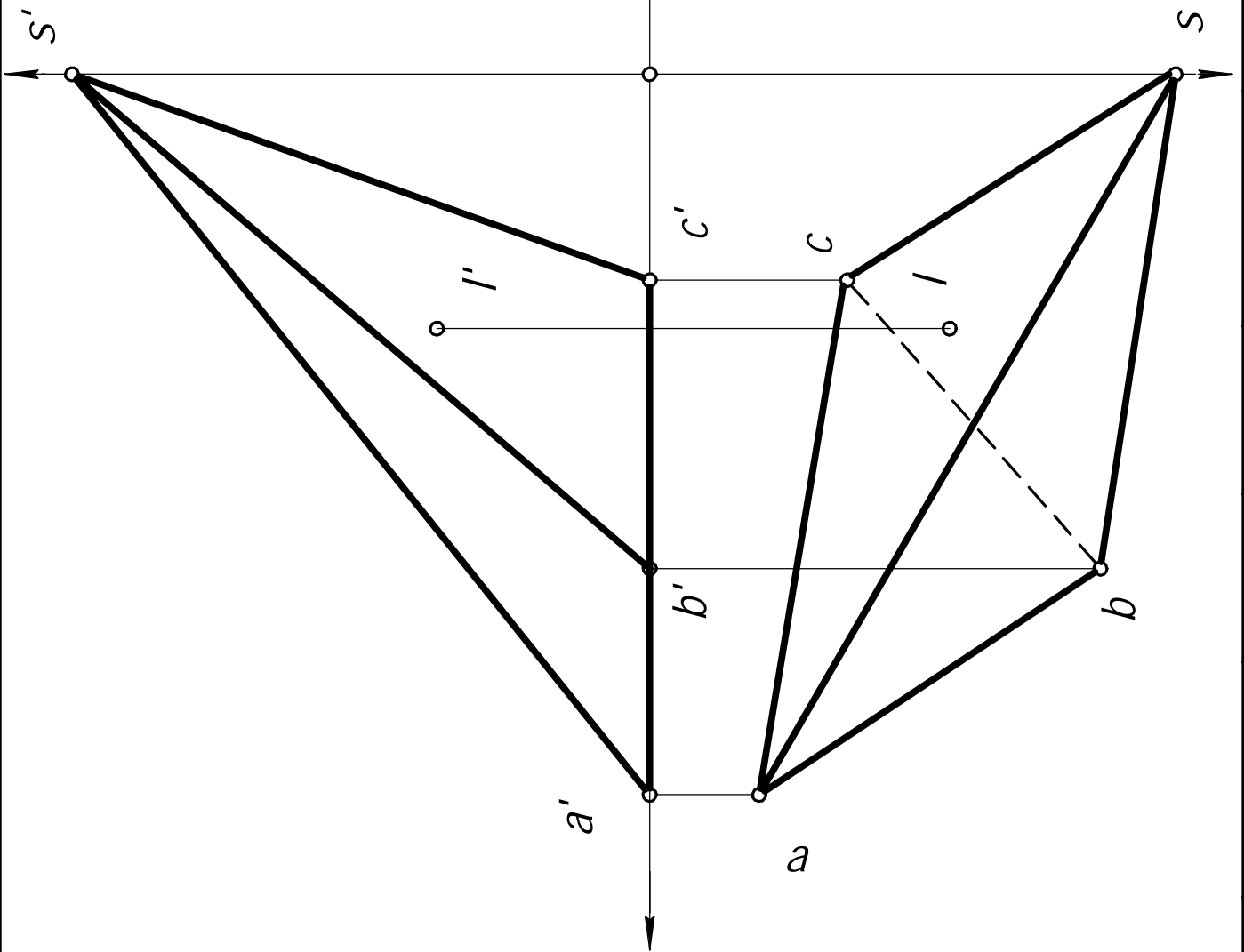

ἰσοσκελῆ	Ἐπιπέδου	ἰσοσκελῆ	ἰσοσκελῆ	ἰσοσκελῆ
----------	----------	----------	----------	----------

Ἐπιπέδου ἰσοσκελῆ

Ἐπιπέδου	ἰσοσκελῆ	ἰσοσκελῆ	ἰσοσκελῆ	ἰσοσκελῆ
----------	----------	----------	----------	----------

Ἐπιπέδου	7
----------	---

Ἐπίθετος ἰσοδυναμίας

Ἐπίθετος ἰσοδυναμίας	Ἐπίθετος ἰσοδυναμίας	Ἐπίθετος ἰσοδυναμίας	Ἐπίθετος ἰσοδυναμίας	Ἐπίθετος ἰσοδυναμίας
Ἐπίθετος ἰσοδυναμίας	Ἐπίθετος ἰσοδυναμίας	Ἐπίθετος ἰσοδυναμίας	Ἐπίθετος ἰσοδυναμίας	Ἐπίθετος ἰσοδυναμίας

Ἐπίθετος ἰσοδυναμίας	Ἐπίθετος ἰσοδυναμίας	Ἐπίθετος ἰσοδυναμίας	Ἐπίθετος ἰσοδυναμίας	Ἐπίθετος ἰσοδυναμίας
Ἐπίθετος ἰσοδυναμίας	Ἐπίθετος ἰσοδυναμίας	Ἐπίθετος ἰσοδυναμίας	Ἐπίθετος ἰσοδυναμίας	Ἐπίθετος ἰσοδυναμίας

Ἐπίθετος ἰσοδυναμίας

Ἐπίθετος ἰσοδυναμίας

o s

Íîñđíáíèá ìđèáèèæáííũ ðàçâđòíê
ðàçâđòúâàòèèñÿ èèíáé÷àòũ ìîâđòíîñâé

Óñêíáíúâ ðàçâđòèè Íáđàçâđòúâàòèèñÿ
ìîâđòíîñâé ñòđíÿ ã òàèíé ìîñèáâîâàòèèíîè:

Íîñ. è ãàòà
Èíà. 1 ãàòè
Áçáí. èíà. 1
Íîñ. è ãàòà
Èíà. 1 ìñâè

Ἐἰς τὴν ἰσοσκελῆ	ἰσοσκελῆ	ἰσοσκελῆ	ἰσοσκελῆ	ἰσοσκελῆ
Ἐἰς τὴν ἰσοσκελῆ	ἰσοσκελῆ	ἰσοσκελῆ	ἰσοσκελῆ	ἰσοσκελῆ

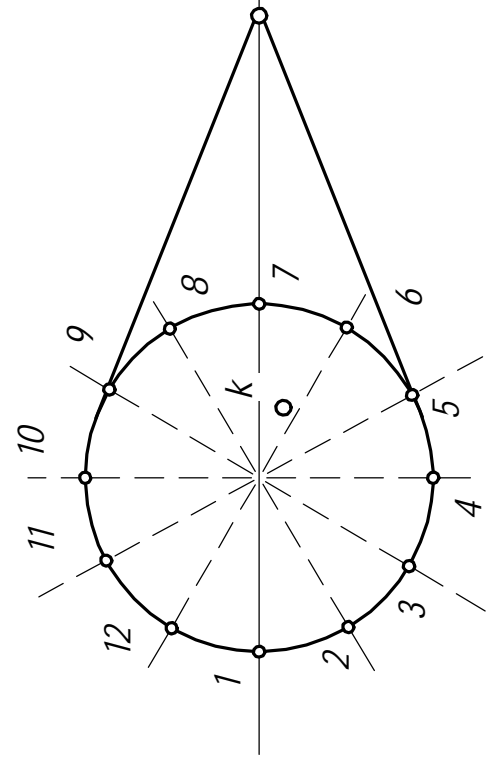
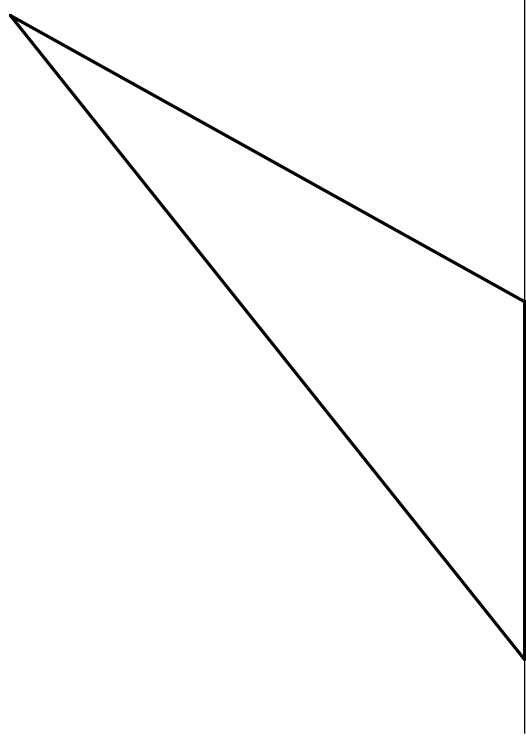

Ἐἰς τὴν ἰσοσκελῆ	ἰσοσκελῆ	ἰσοσκελῆ	ἰσοσκελῆ	ἰσοσκελῆ
------------------	----------	----------	----------	----------

Ἐπιπέδου ἰσοσκελῆ

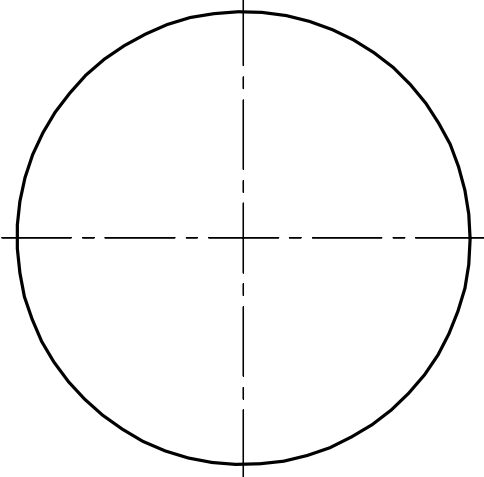
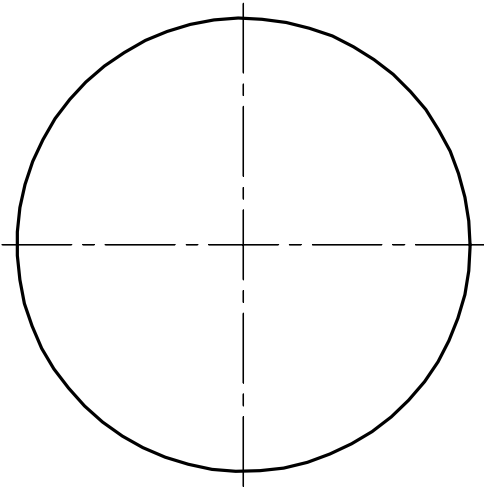
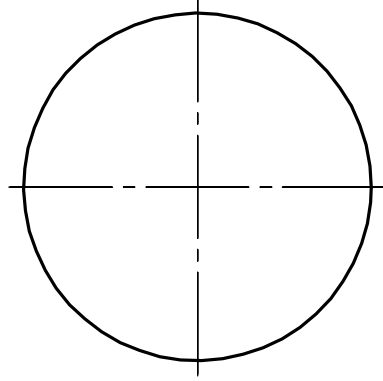

Ìrâì. è ààÒà	Èrâ. ¹ àààé	Àçâì. èrâ. ¹	Ìrâì. è ààÒà	Èrâ. ¹ ìrâé
--------------	-------------	--------------	--------------	-------------

Èçì.	Èèñò	¹ àrêóì.	Ìrâì.	Ààòà
------	------	----------	-------	------

Ëíæáí áðí àÿ ãðàòèèà

Î áùèà ìðàáèèà î ôîðî èáí èÿ ÷ áððàæáé

Ôîðî àòù

Î áíçíá-áíèÿ ôîðî àòîá	Ðàçè áðù ìòîðîíî ôîðî àòà, ìì
À0	
À1	
À2	
À3	
À4	
À5	

Ëíá 1 ìíáé.	Îíáí. è áàòà
Àçáí. èíá. 1	Ëíá. 1 áòáé.
Îíáí. è áàòà	
Ëíá 1 ìíáé.	

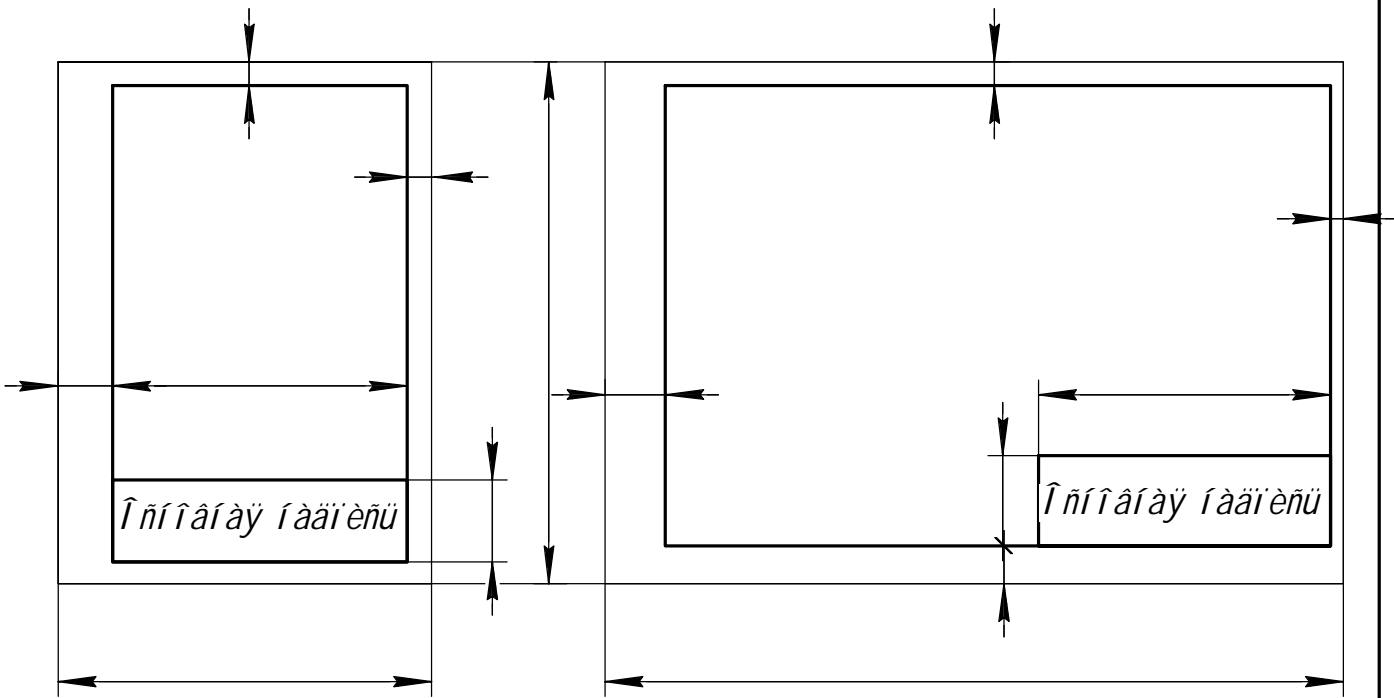

Î ñî î âî àÿ í àäî èñü

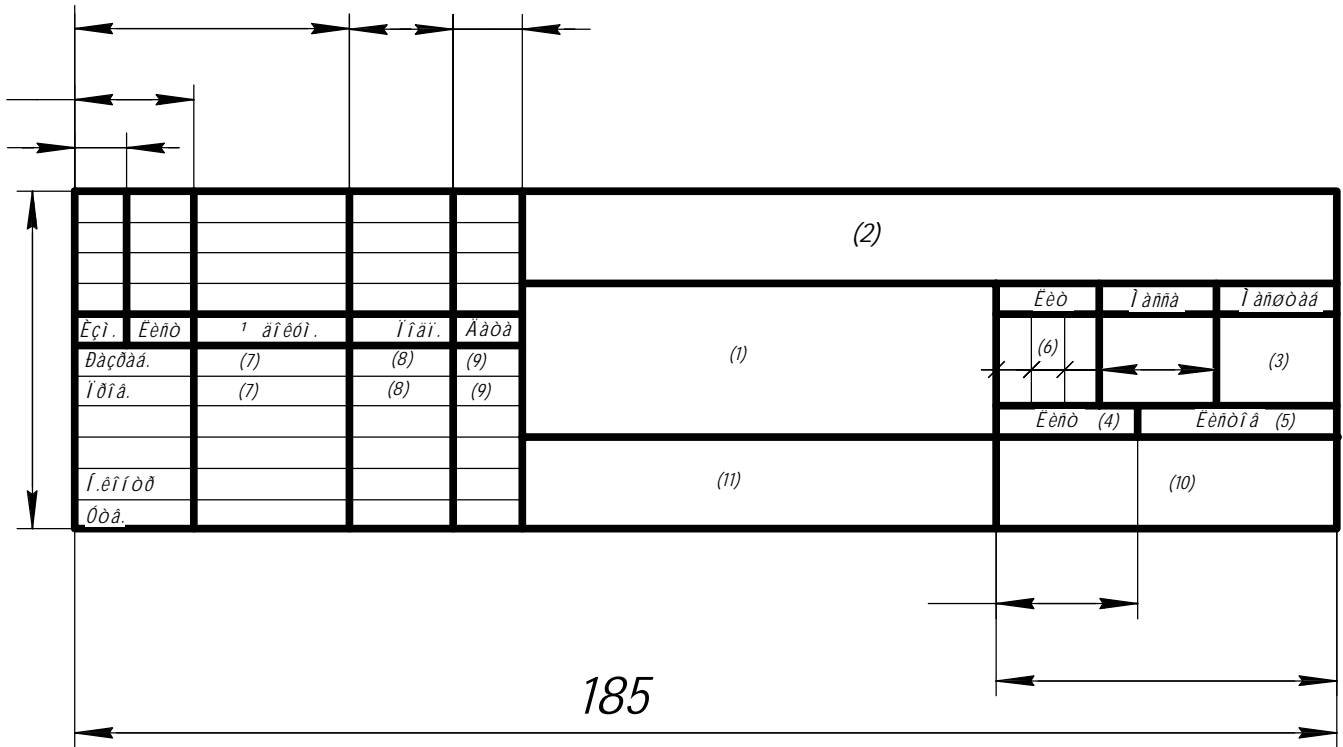

Î ñî î âî àÿ í àäî èñü

Ñî ääðæàí èå:

- 1 -
- 2 -
- 3 -
- 4 -
- 5 -
- 6 -
- 7 -
- 8 -

Íîî. è äàòà	Èîà. ¹ äàð.	Âçàì. èîà. ¹	Íîî. è äàòà	Èîà. ¹ òñè.
-------------	-------------	--------------	-------------	-------------

Êçì.	Èèò	¹ àñèîì.	Íîî.	Ààðà
------	-----	----------	------	------

Ôî ðî àòû, âèäü, ðàçðåçû

Èèò
2

Ôî ðì àòù, âèäù, ðàçðàçù

9 -

10 -

11 -

Ì àñøðàáú

Ì àñøðàáî Ì Í àçùââàòñÿ _____

Ì àñøðàá òì áí ùøáf èÿ						
Ì àñøðàá óââèè-áí èÿ						

Ëèí èè

Ëía 1 ìíàé.	Ìíài. è ààòà	Ìíài. è ààòà	Ëía 1 áòáé.	Ëía 1 áòáé.	Ìíài. è ààòà
Ëìa 1 ìíàé.	Ìíài. è ààòà	Ìíài. è ààòà	Ëía 1 áòáé.	Ëía 1 áòáé.	Ìíài. è ààòà

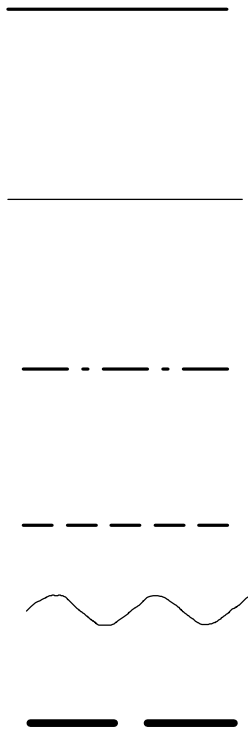

Ëìa 1 ìíàé.	Ìíài. è ààòà	Ëía 1 áòáé.	Ìíài. è ààòà	Ëìa 1 áòáé.	Ìíài. è ààòà
-------------	--------------	-------------	--------------	-------------	--------------

Ôî ðì àòù, âèäù, ðàçðàçù

Ὀἰ̇ δῖ̇ ἀοὺ̇, ἀεῦ̇, δὰçð̇

Øðèòòù ÷ àðòáæíûá

Δὰçì áð øðèòòà î̇ ð̇äääëÿàòñÿ _____

Ὀñòáí̇ âèáí̇ ù̇ ñèääòðùèá δὰçì áðù̇ øðèòòà:

Øèðεί̇ à áóéâû̇ î̇ ð̇äääëÿàòñÿ _____

Ñòáí̇ ààðò òñòáí̇ àâèèääàð ñèääòðùèá òèì̇ ù̇ øðèòòà:

òèì̇ Á
òèì̇ Á

Øðèòòù ÷ àðòáæíûá

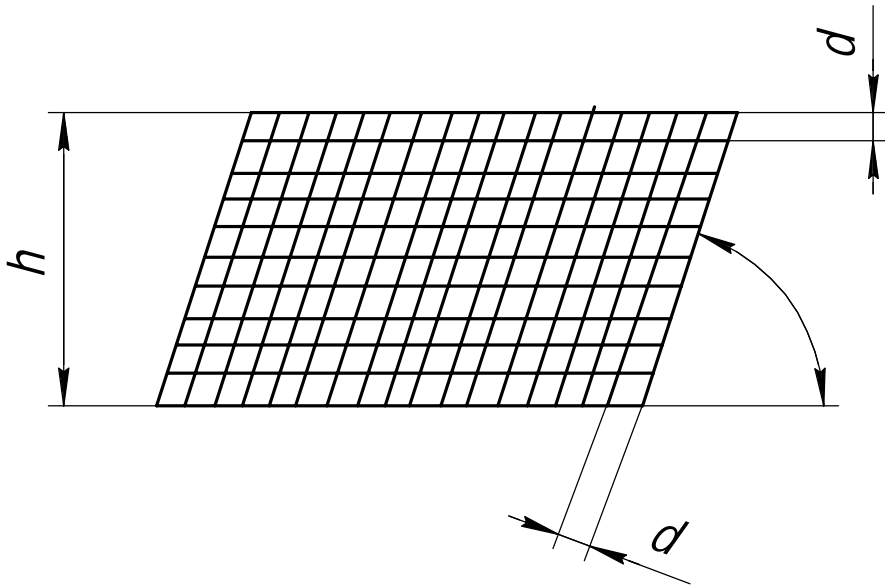

Ì̇ ð̇. è äàòà
È̇ ð̇. 1 äàè
Áçáì. è ð̇. 1
Ì̇ ð̇. è äàòà
È̇ ð̇. 1 ð̇ ð̇

Èçì. Èèñò	1 àñèóì.	Ì̇ ð̇. Ì̇ ð̇.	Ààòà
-----------	----------	---------------	------

Ὀἰ̇ δῖ̇ ἀοὺ̇, ἀεῦ̇, δὰçð̇

Èèñò
4

Øðèòò òèì Á ¹ 10 ñ í à è è î í î ì î ê î ë î 75°

ô à è ó è ü ò ð ò

Øðèòò òèì Á ¹ 10 á â ç í à è è î í à

ô à è ó è ü ò ð ò

Øðèòò òèì Á ¹ 14 ñ í à è è î í î ì î ê î ë î 75°
Í à ì ð à à è à í è à / Ñ ì à ö è à è ü í î ñ ò ü

Øðèòò òèì Á ¹ 14 á â ç í à è è î í à
Í à ì ð à à è à í è à / Ñ ì à ö è à è ü í î ñ ò ü

Øðèòò òèì Á ¹ 20
Ø è ò ð :

Í à ì ð à à è à í è à	Á ç à ì . è í à . ¹	È í à . ¹ á ò á è .	Í ò à ì . è à à ò à
È í à . ¹ í ò á è .			

È ç ì .	È è ñ ò	¹ à ì è ó ì .	Í ò à ì .	Á à ò à
---------	---------	--------------------------	-----------	---------

Ëçĩ áðàæáí èÿ - âèäü,
ðàçðåçû, ñå÷-áí èÿ

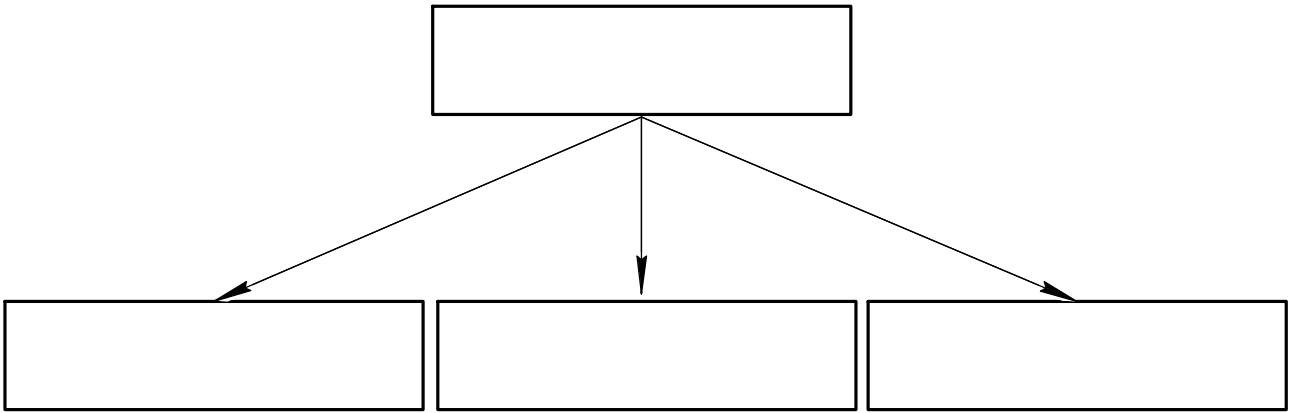

Âèä - _____

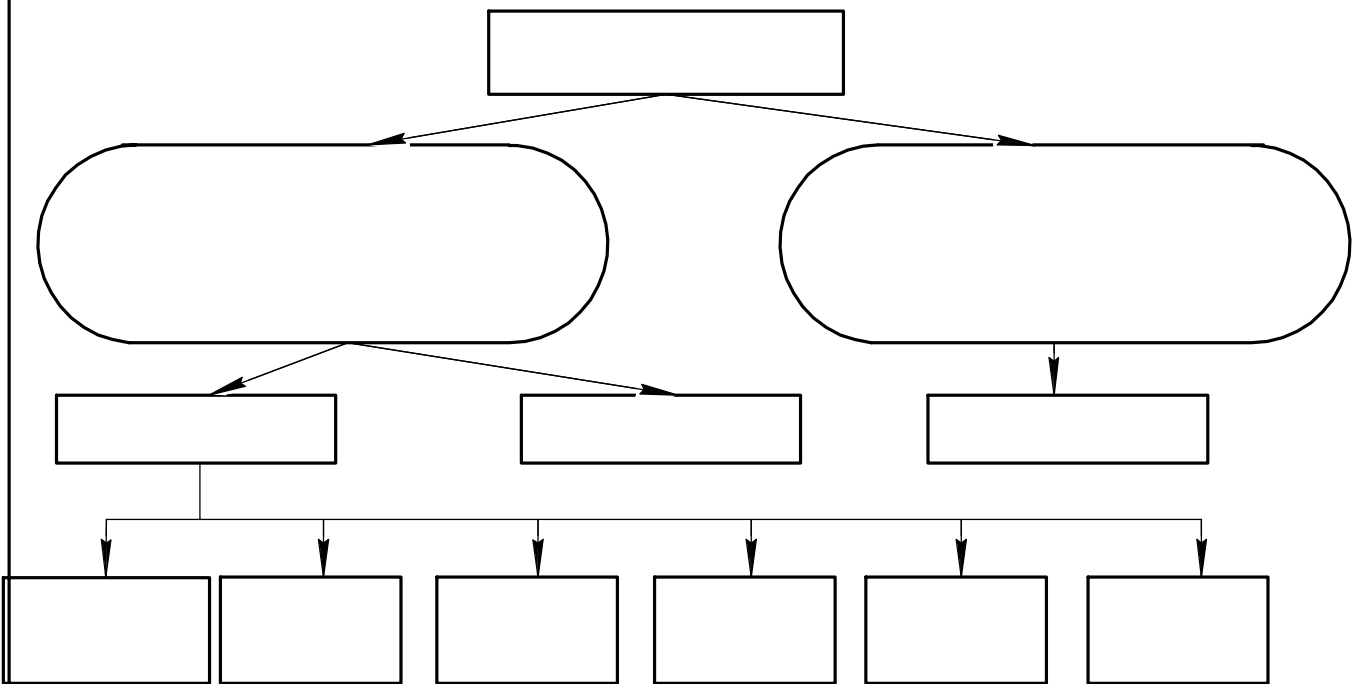

Ïĩĩ. è äàòà
Ëĩà. 1 äòàè
Âçáĩ. èĩà. 1
Ïĩĩ. è äàòà
Ëĩà. 1 Ïĩäè

Ëçĩ.	Ëèñò	1 äĩèóĩ.	Ïĩĩ.	Äàòà
------	------	----------	------	------

Ôĩ ðì àòù, âèäü, ðàçðåçû

Âèä

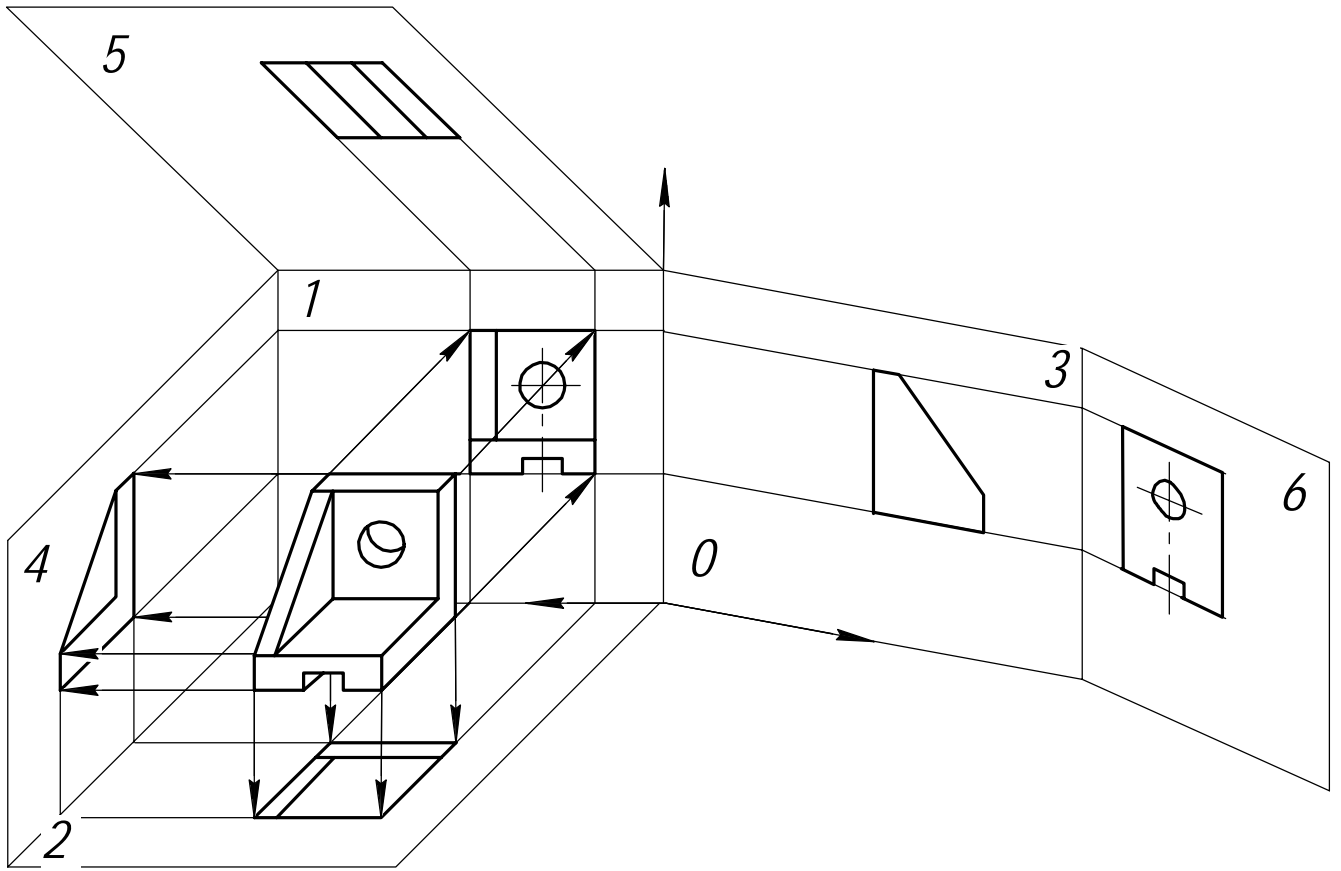

Îñíîáíùâ âèäù

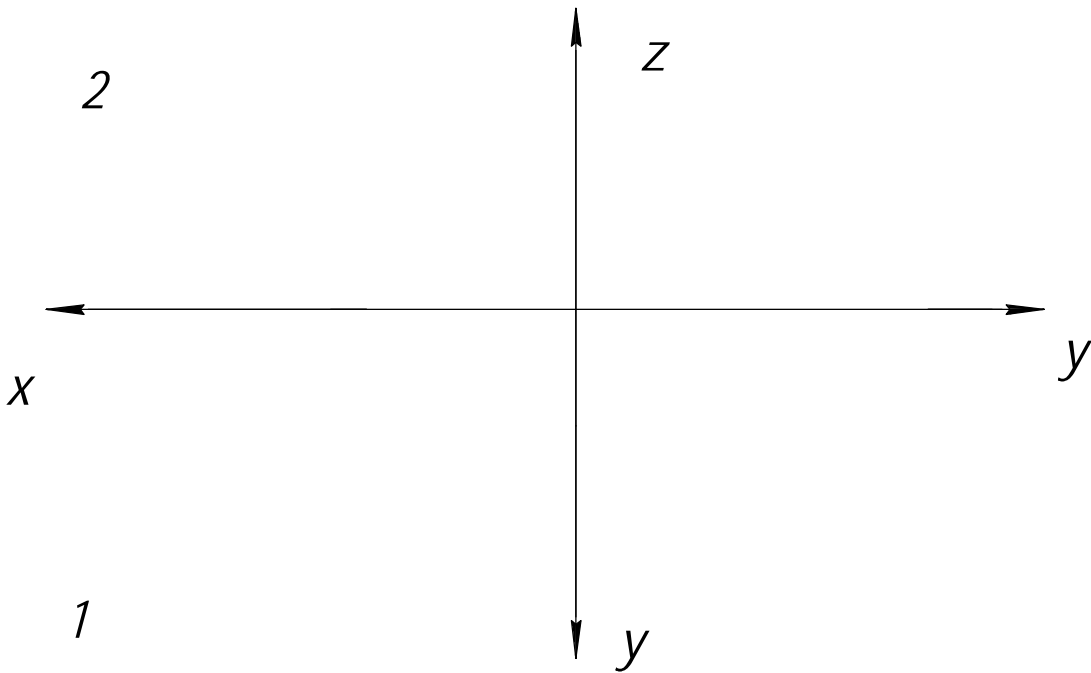

Êía 1 ìîäè.	Îîäî: è ààðà	Êía 1 àòàé.	Îîäî: è ààðà
Êçì. Êèòò	1 àîèòî.	Îîäî: Êèòò	Êèòò

Êçì. Êèòò	1 àîèòî.	Îîäî: Êèòò	Êèòò
-----------	----------	------------	------

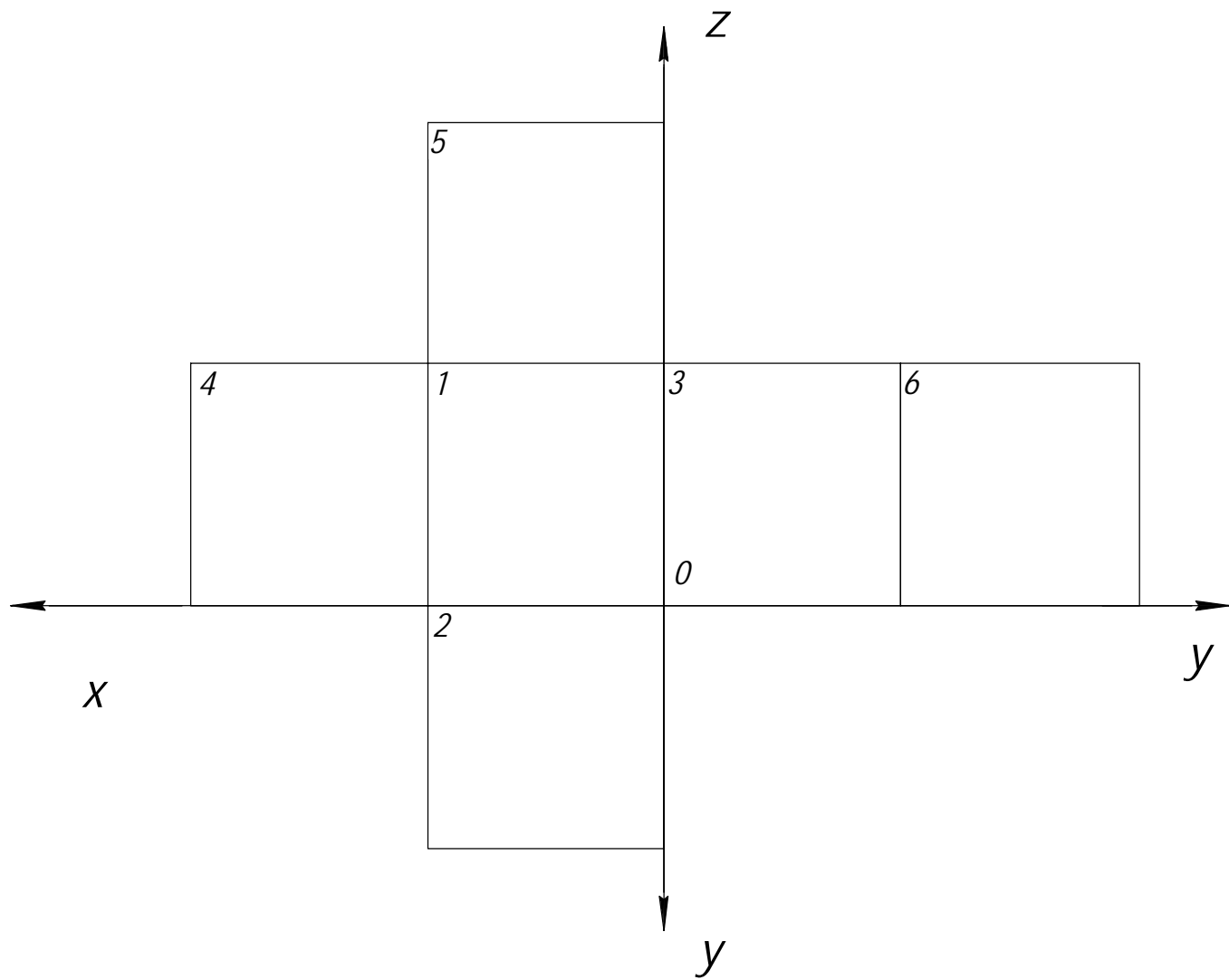

Ìäì. è äàòà	Èìà. 1 äàè.	Äçì. èìà. 1	Ìäì. è äàòà	Èìà. 1 ìäè.
-------------	-------------	-------------	-------------	-------------

Èçì.	Èèò	1 äèóì.	Ìäì.	Äòà
------	-----	---------	------	-----

Ôî ðì àòù, âèäù, ðàçðåçù

2

1

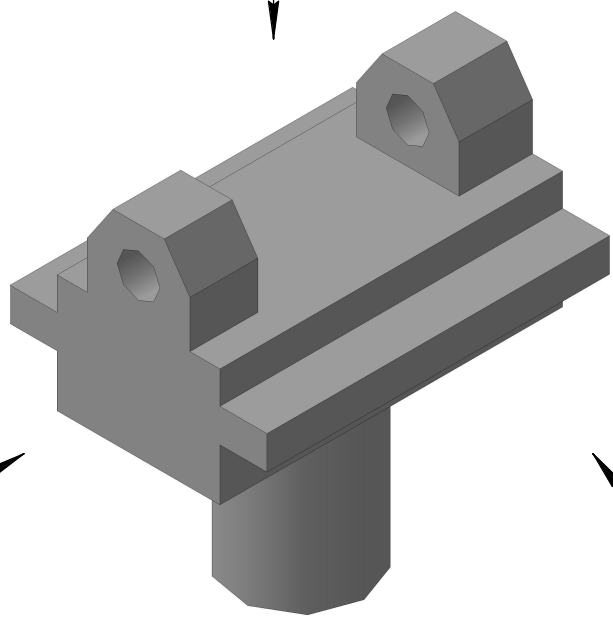

3

Î ñî î â î ù â â è ä ù

â è ä ä î ú é â è ä

â è ä ñ è ä ä ä

â è ä ñ ä ä ð ö ö

Êîä. Êèòò	Êîä. Êèòò	Êîä. Êèòò	Êîä. Êèòò	Êîä. Êèòò
Êîä. Êèòò	Êîä. Êèòò	Êîä. Êèòò	Êîä. Êèòò	Êîä. Êèòò
Êîä. Êèòò	Êîä. Êèòò	Êîä. Êèòò	Êîä. Êèòò	Êîä. Êèòò
Êîä. Êèòò	Êîä. Êèòò	Êîä. Êèòò	Êîä. Êèòò	Êîä. Êèòò
Êîä. Êèòò	Êîä. Êèòò	Êîä. Êèòò	Êîä. Êèòò	Êîä. Êèòò

Ôî ðì àòù, âèäù, ðàçðåçù

Êèòò
9

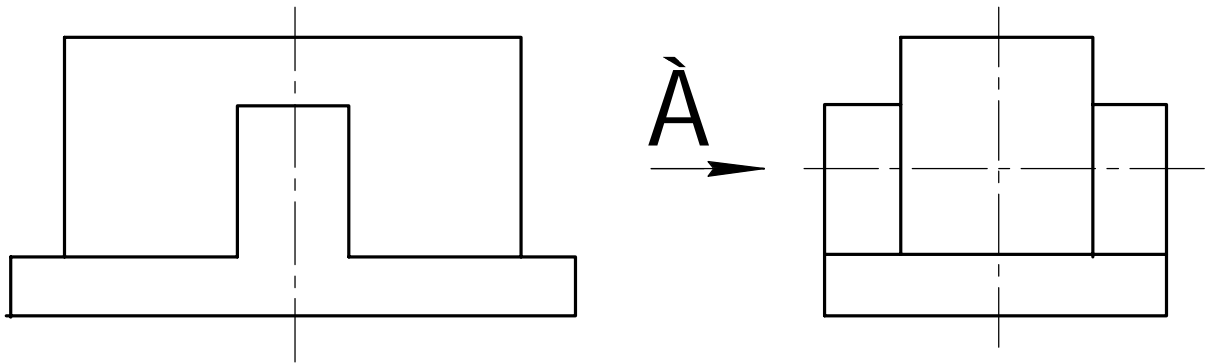

Äîîîëíèòâëüíûâ è ì añòíûâ âèäû

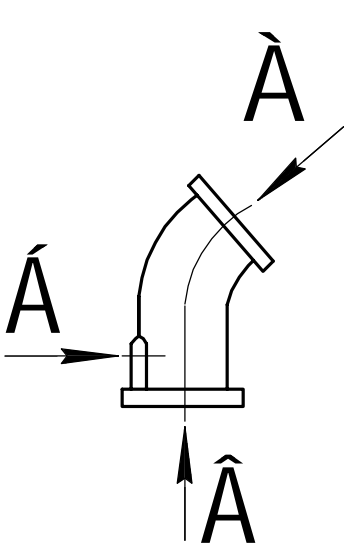

À À ã

à)

á)

Ἐçì.	Ἐèñò	ῥ ἀῖεóì.	Ἰταῖ.	Ἀαὸà
------	------	----------	-------	------

Ἰταῖ. ἔ ἀαὸα	Ἐῖα. ῥ ἀαῖ	Ἀκαῖ. εῖα. ῥ	Ἰταῖ. ἔ ἀαὸα	Ἐῖα. ῥ Ἰταῖ.
--------------	------------	--------------	--------------	--------------

Äîîîëíèòäëüíûá è ì àñòíûá âèäù

Á(2:1)

Á

Â (2:1)

â)

ã)

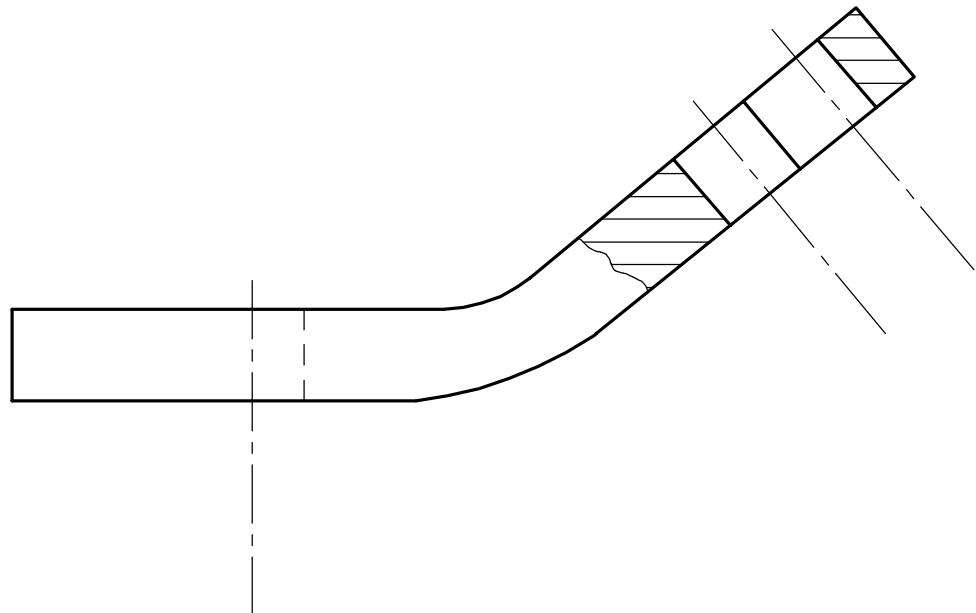

Éíá ¹ ìîáë.	Íîáì. è ààòá	Áçàì. èíá ¹	Éíá ¹ áòáë.	Íîáì. è ààòá
Éçì. Èëñò	¹ áñéòì.	Íîáì.	Áàòá	

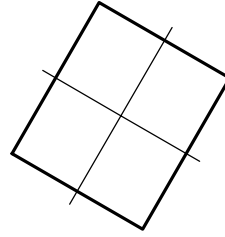
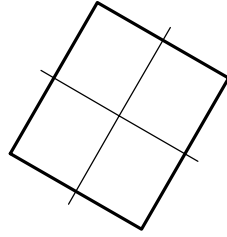
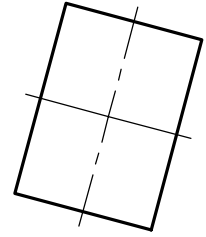
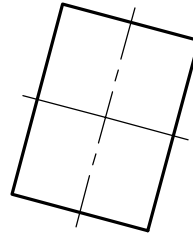

<i>Ἰὰεὶ ἰάιᾶᾶεᾶ</i>	<i>Ἰάιçíà-áíèÿ</i>
1. Ἰὰοᾶεᾶεᾶ-ἀνεεᾶ ἰὰοᾶδεᾶεῦ	
2. Ἰᾶὶ ἀοᾶεᾶεᾶ-ἀνεεᾶ ἰὰοᾶδεᾶεῦ	

Δαῖδα-

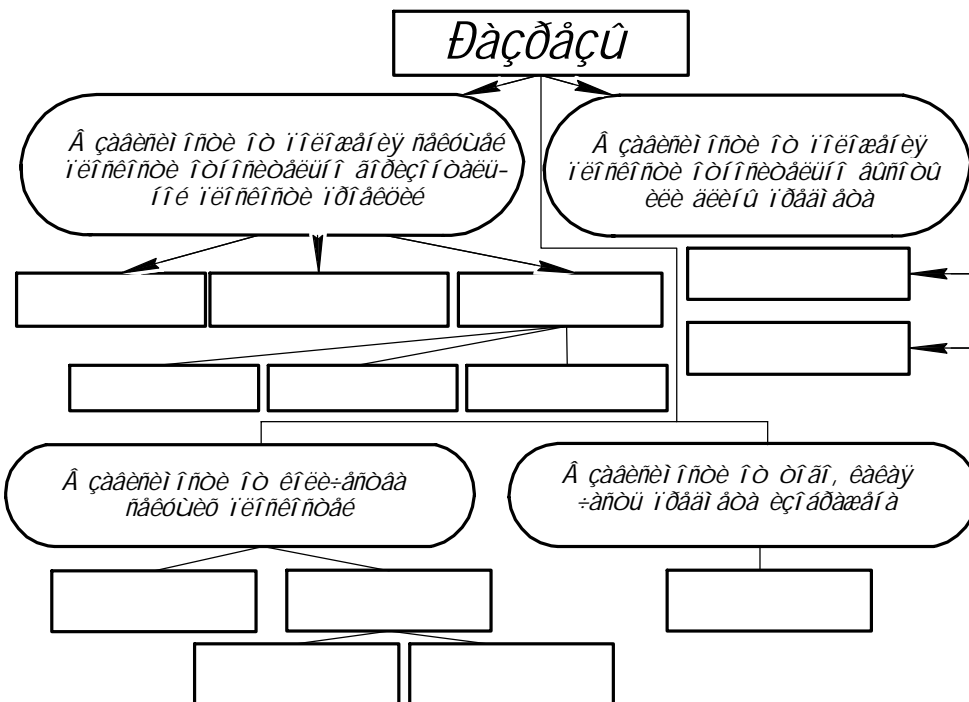

Ἰᾶἰ. εᾶοᾶ
Ἰᾶ. 1 ᾶοᾶ
Ἄçáἰ. εἰᾶ. 1
Ἰᾶἰ. εᾶοᾶ
Ἰᾶ. 1 ἰᾶᾶ
Ἰᾶ. 1 ἰᾶᾶ

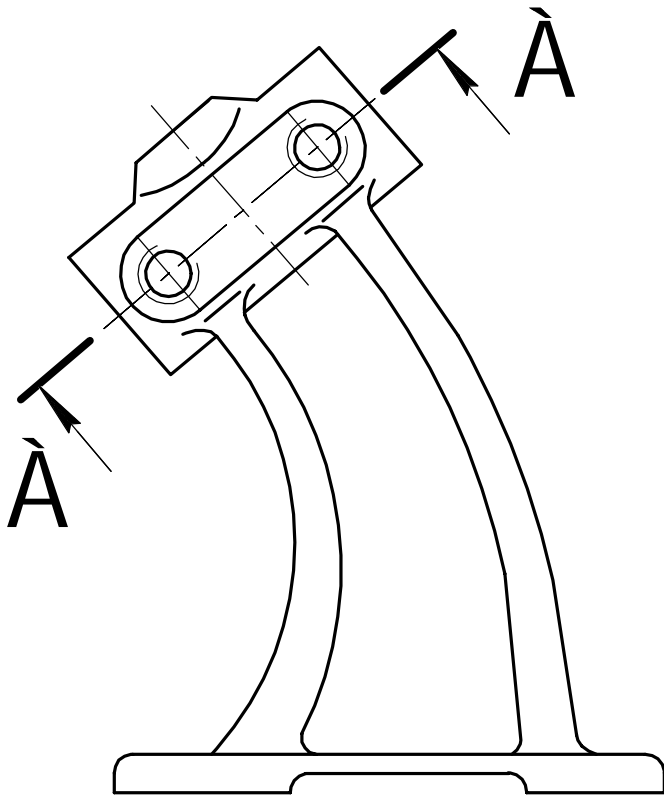
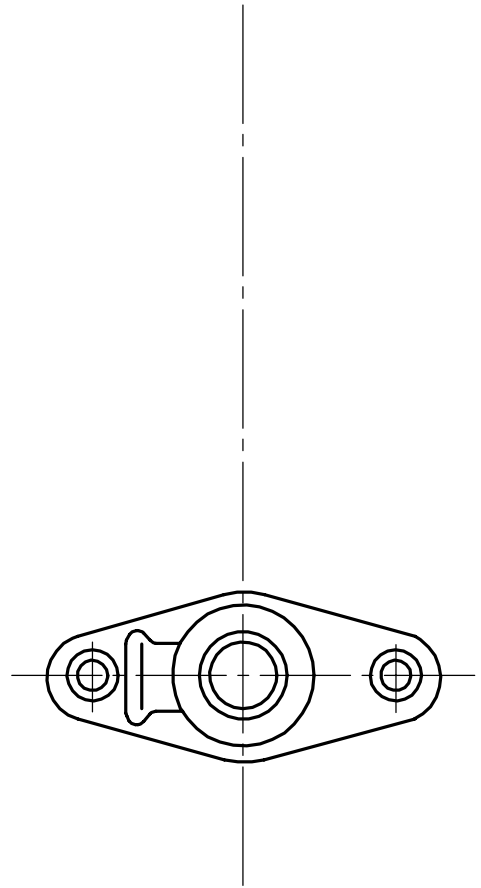
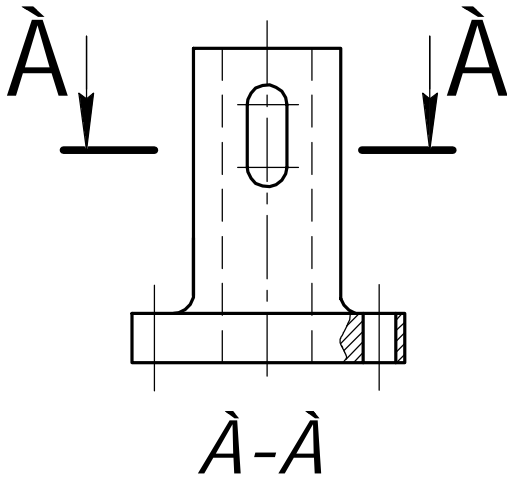

Èíà 1 ìñàè.	Ìñàè. è ààðà	Àçàì. èíà 1	Èíà 1 ààèè.	Ìñàè. è ààðà
Èçì. Èèòò	1 àèèòì.	Ìñàè.	Ààðà	

Ì àñòí ùé ðàçðàç

Ì àñòí ùé ðàçðàç-

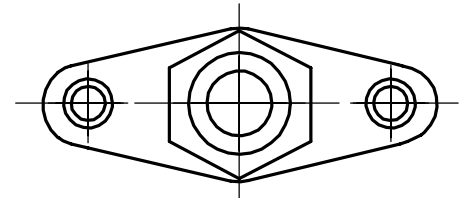
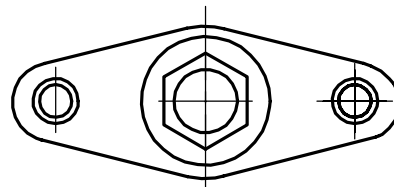
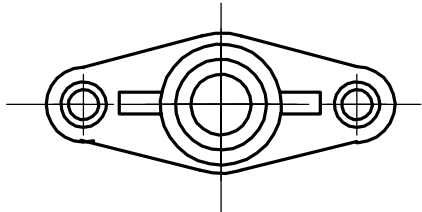
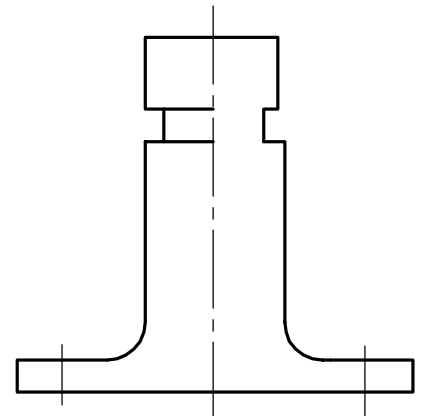
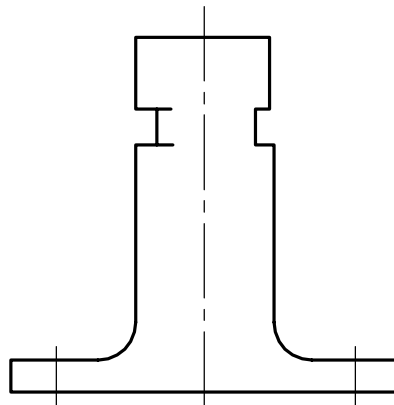
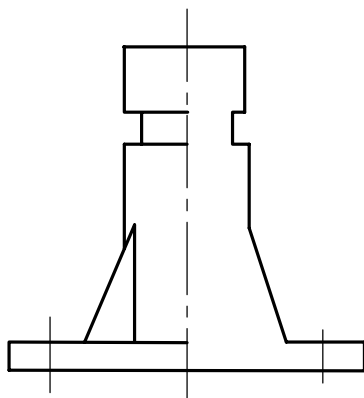
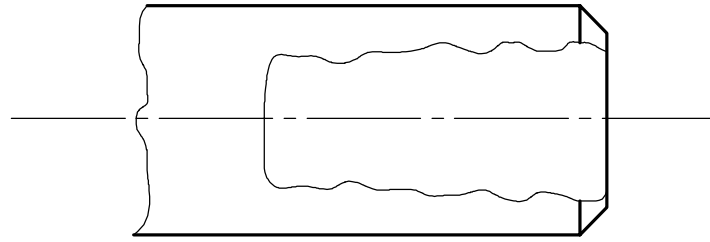

Èíá 1 ìíáé.	Ìíáí: è ààòá	Èíá 1 àòáé.	Ìíáí: è ààòá
Èçì.	Èéñò	1 àíéòì.	Ìíáí: Ààòá

Ì àñòí ùé ðàçðàç

Ì àñòí ùé ðàçðàç-

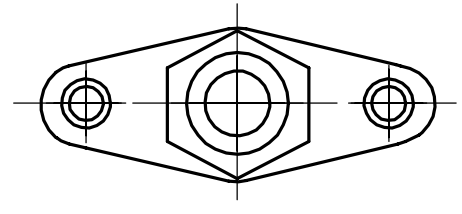
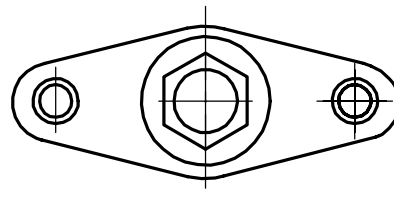
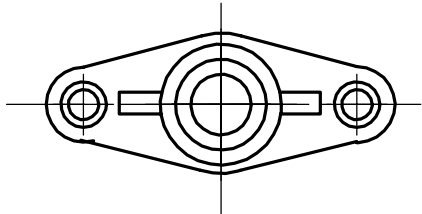
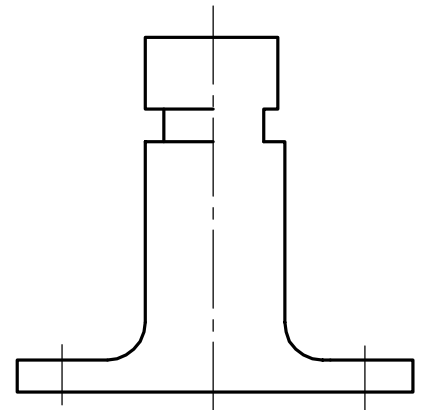
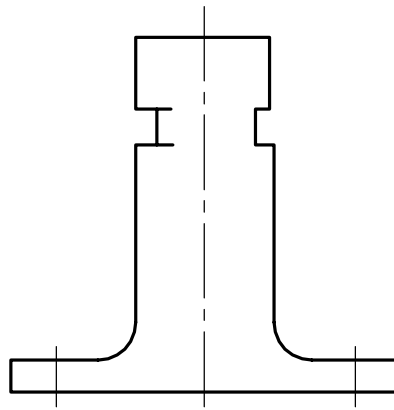
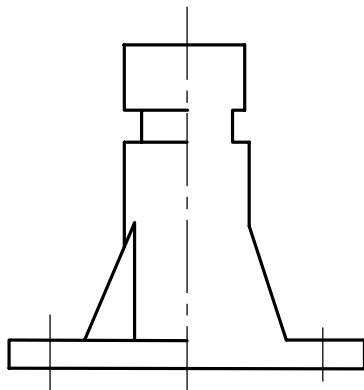
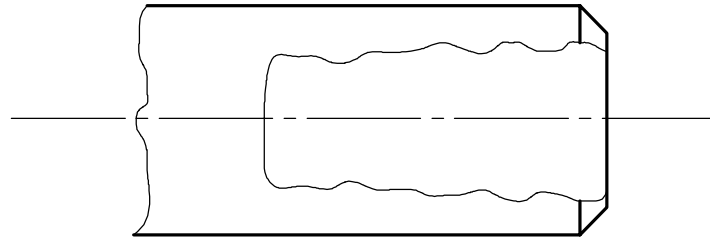

Èíá 1 ìíáé.	Ìíáí: è ààòá	Èíá 1 àòáé.	Ìíáí: è ààòá
Èçì.	Èéñò	1 àíéòì.	Ìíáí: Ààòá

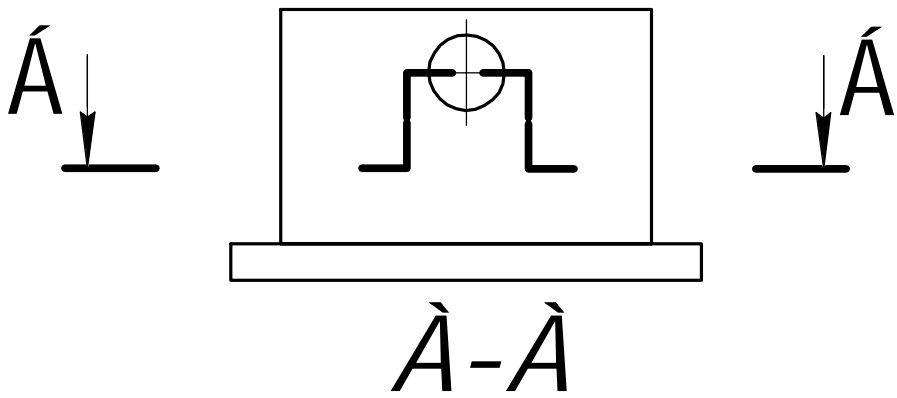

Á-Á

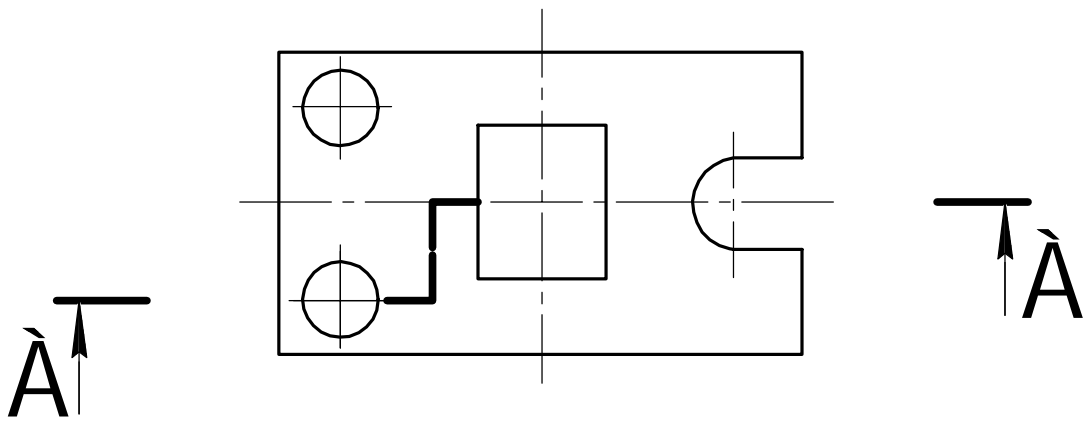

Ἡ ἀρχὴ τῆς ἀρχῆς
Ἡ ἀρχὴ τῆς ἀρχῆς
Ἡ ἀρχὴ τῆς ἀρχῆς
Ἡ ἀρχὴ τῆς ἀρχῆς
Ἡ ἀρχὴ τῆς ἀρχῆς

Ñêī æī ûé ðàçðåç (ëī ì àī ûé)

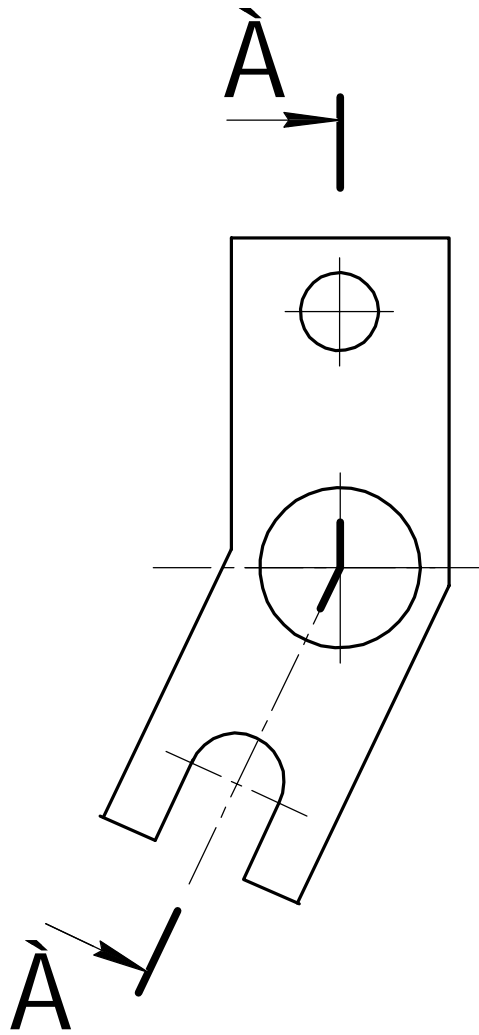

Сечения

Ñå÷åíå-

Ñå÷åíå



Éīā 1 īīāē.	Īīāī. è ààðā	Āçāī. èīā 1	Éīā 1 āāē.	Īīāī. è ààðā
Éçì. Èēñò	1 āīēōī.	Īīāī.	Āāðā	

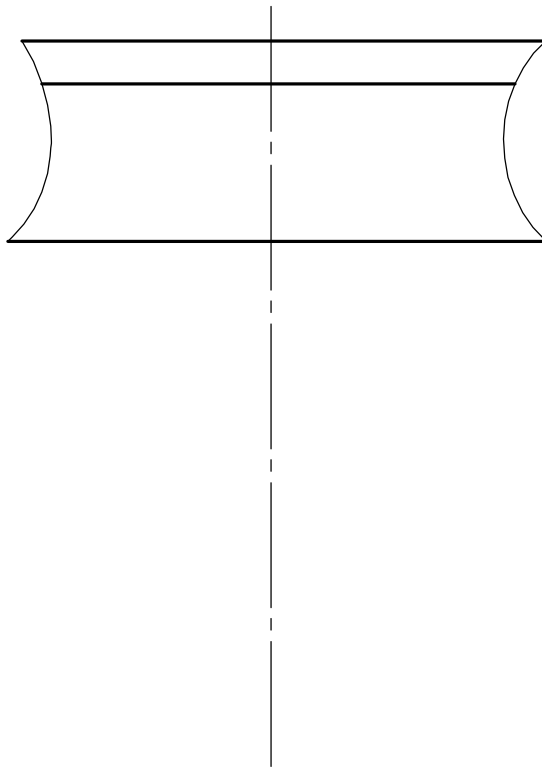
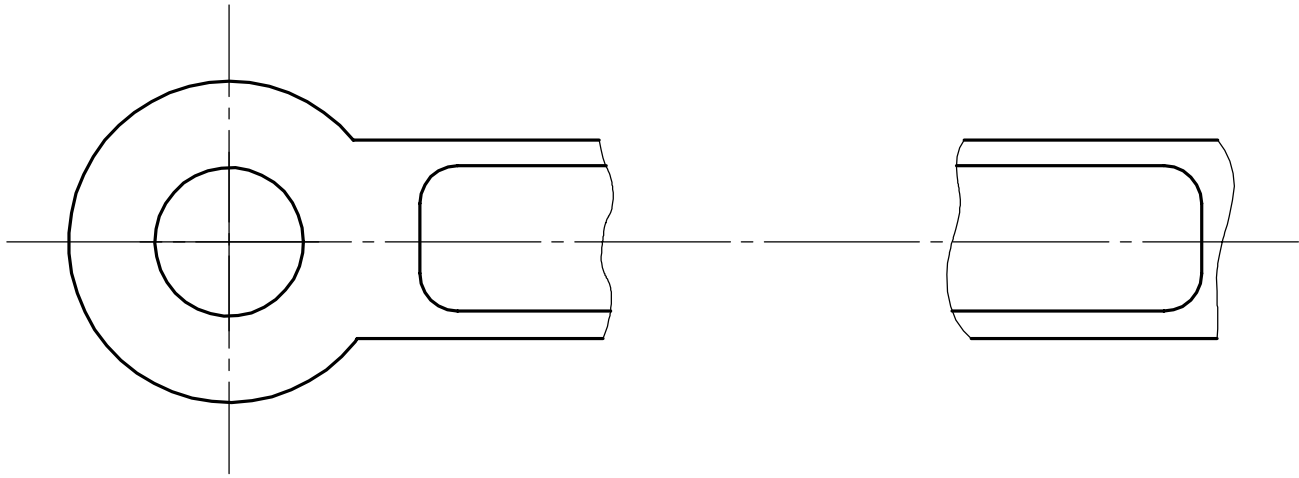

Ířái. è äàòà	Èřà. 1 äàè	Âçái. èřà. 1	Ířái. è äàòà	Èřà. 1 Ířàè
--------------	------------	--------------	--------------	-------------

Âũĩ àñáííî à ñâ÷áíèà

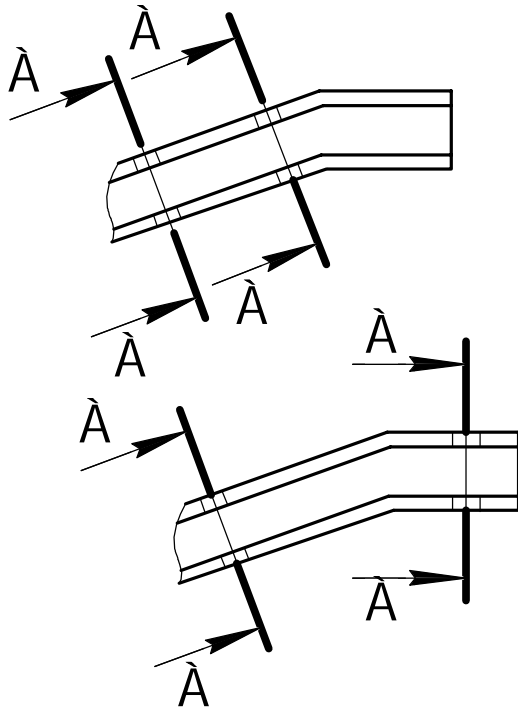

Í àëĩæáííî à ñâ÷áíèà

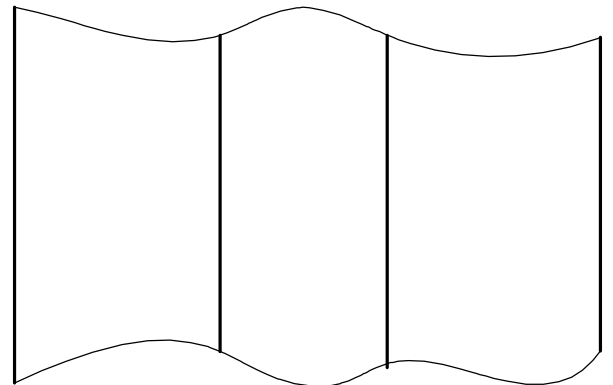
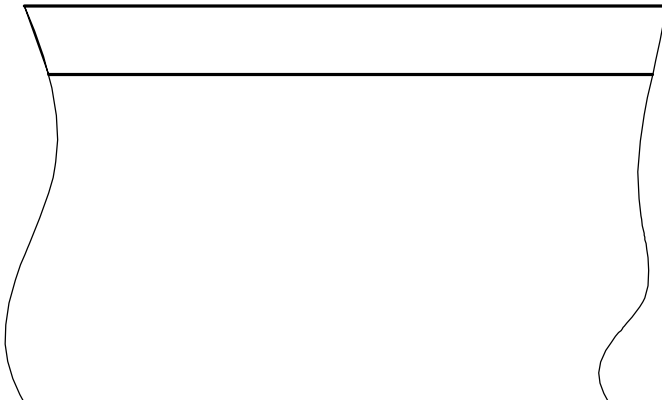

Êía 1 ìĩæ.	Ìĩĩ: è àòòà	Àçãì. èíá 1	Êía 1 àòàé.	Ìĩĩ: è àòòà
Êçì. Êèòò	1 àĩèòĩ.	Ìĩĩ:	Àòòà	

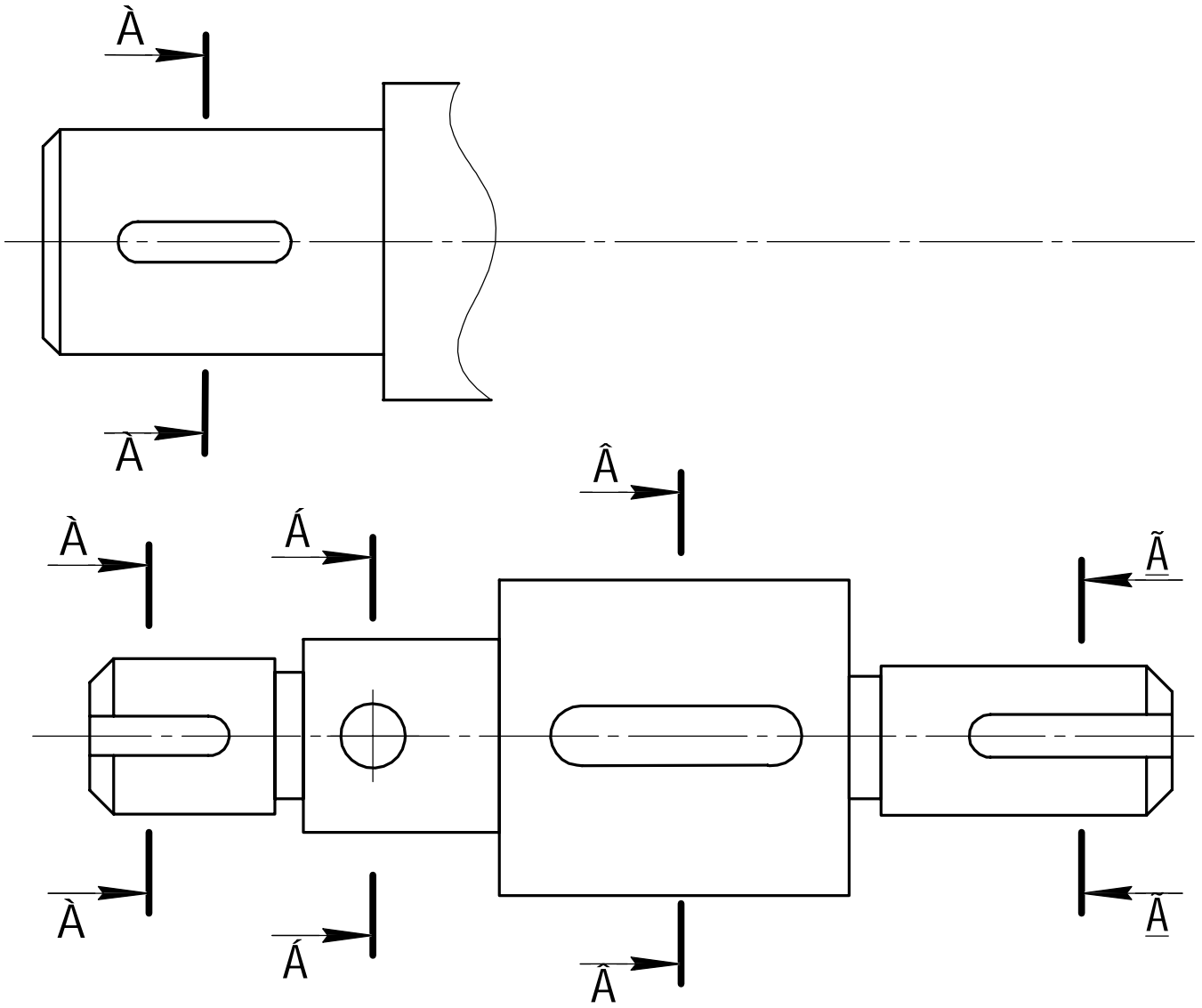

Διαφορά
 $\hat{A}-\hat{A}$

Πρώτη εικόνα
 $\hat{A}-\hat{A}$

Διαφορά
 $\hat{A}-\hat{A}$

Πρώτη εικόνα
 $\hat{A}-\hat{A}$

Πρώτη εικόνα
Επί 1 άκρη
Άκρη επί 1
Πρώτη εικόνα
Επί 1 άκρη

Ó:ááíî-íðàèòè÷ãñêîâ èçääíèá

Íà÷áðòàðäëüí àý ááîî áððèý: ðàáí÷àý òàððàäü äëý çàíèñè èäèèèè:
/ñîñò. À.Á. Íðáðîîá. - Êîñòðîîà. - ÊÑŃŐÀ, 2020.-152 ñ. .: èè.; 30 ñì.
-100 ýêç. Òäèñò: íáíîñðáñòááííóé.

Ðàáí÷àý òàððàäü èçää, òñý á àâòîðñêèé ðàääèèèè

Íáí. è äàðà	Ëíà 1 äàäè	Àçàí. èíà 1	Íáí. è äàðà	Ëíà 1 17äè
-------------	------------	-------------	-------------	------------